

IBM System Storage DS3500

IBM Storage at-a-glance guide

The DS3500 series combines next-generation controller technology with a 6 GB SAS interconnect to the disk drives and the latest high-performance host interface technologies, 6 Gb SAS, 10 Gb iSCSI, and 8 Gb Fibre Channel (FC).

The DS3500 is available in two models. The DS3512 Express Storage System holds up to twelve 3.5-inch SAS disk drives and the DS3524 Express Storage System holds up to twenty-four 2.5-inch (small form factor) SAS disk drives (Figure 1). EXP3512 is a 12-drive enclosure and EXP3524 is a 24-drive enclosure that can be attached to either of the storage subsystems.

Offering substantial improvements at a price that fits most budgets, the DS3500 delivers superior price-to-performance ratios, functionality, scalability and ease of use for the entry-level storage user.



Figure 1. DS3512 (top) and DS3524 (bottom) front view

Did you know?

The IBM DS3500 is ready for the move to 10 Gb iSCSI with the four ports that it has. It provides backwards compatibility with 1Gb iSCSI environments, protecting your current investment while transitioning to the network of the future. It also maintains simplicity by using a standard RJ45 connection without the need of additional SFPs.

DS3500 highlights

The DS3500 is available with single or dual controllers, with the option to further enhance the performance of your dual controller system with the Turbo Performance option. You choose the configuration to match your current performance requirements and budget, and IBM offers a way to protect your investment with an upgrade path to later add the options that you need. With its simple, efficient, and flexible approach to storage, the DS3500 is a cost-effective, fully integrated complement to IBM System x® servers, IBM BladeCenter®, and IBM Power Systems™.

- The next-generation 6 Gbps SAS systems deliver midrange performance and scalability at entry-level prices.
- It provides investment protection and cost-effective backup and recovery with remote mirror across Fibre Channel and compatibility with DS5000 and DS4000®.
- Full disk encryption with local key management provides relentless data security.
- Drive and expansion enclosure intermix cost-effectively to meet all application, rack, and energy-efficiency requirements.

DS3500 part numbers

Table 1 lists several DS3500 part numbers associated with the IBM System Storage DS3500 series models.

Table 1. DS3500 part numbers

Part number	Description
1746-A2S	IBM System Storage DS3512 Express Single Controller Storage System
1746-A2D	IBM System Storage DS3512 Express Dual Controller Storage System
1746-A4S	IBM System Storage DS3524 Express Single Controller Storage System
1746-A4D	IBM System Storage DS3524 Express Dual Controller Storage System
1746-T4D	IBM System Storage DS3524 Express DC Dual Controller Storage System
1746-A2E	IBM System Storage EXP3512 Express Storage Expansion Unit
1746-A4E	IBM System Storage EXP3524 Express Storage Expansion Unit

DS3500 product overview

The DS3500 is available in two models, and each model can have either one or two controllers:

- The DS3512 Express Storage System holds up to twelve 3.5-inch SAS disk drives.
- The DS3524 Express Storage System holds up to twenty-four 2.5-inch SAS disk drives.

The capacity of a DS3500 system can be increased to up to 192 disk drives with the attachment of EXP3500 expansion units. It is also available in two models:

- The EXP3512 Express Expansion Unit holds up to twelve 3.5-inch SAS disk drives.
- The EXP3524 Express Expansion Unit holds up to twenty-four 2.5-inch SAS disk drives.

All models support dual-port, high-performance, high-capacity nearline and self-encrypting drives. Near-line SAS and SED disk drives of the same form factor can be intermixed within the appropriate DS3500 or EXP3500 enclosure. You can even intermix EXP3512 and EXP3524 expansion units behind either a DS3512 or DS3524 storage system.

Table 2 provides a brief overview of IBM System Storage DS3500 Express models.

Table 2. DS3500 specifications (part 1)

Feature	Description
RAID controller	Dual active, hot-swappable controllers.
Cache	1 GB cache per controller with 2 GB upgrade. <ul style="list-style-type: none"> ● Mirrored, battery-backed, destaged to flash
Host interface	Four interface options (SAS, iSCSI/SAS, FC/SAS): <ul style="list-style-type: none"> ● Four or eight 6 Gbps SAS ports ● Eight 8 Gbps Fibre Channel ports and four 6 Gbps SAS ports ● Eight 1 Gbps iSCSI ports and four 6 Gbps SAS ports ● Four 10 Gbps iSCSI ports and four 6 Gbps SAS ports
Drive interface	Two 6 Gb SAS drive expansion ports.
Expansion enclosures	EXP3512 (2U 12 3.5-in drive) and EXP3524 (2U 24 2.5-in drives) enclosures. <ul style="list-style-type: none"> ● Enclosures can be intermixed behind a controller.
Maximum drives supported	Up to 192 drives: high performance SAS drives, nearline SAS drives, and SED SAS drives. <ul style="list-style-type: none"> ● EXP3512 supports 12 3.5-in drives. ● EXP3524 supports 24 2.5-in drives. Both of the expansion enclosures can be intermixed behind a DS3500.
Supported systems	<ul style="list-style-type: none"> ● IBM AIX® ● IBM Linux on POWER® (LoP) ● Microsoft Windows Server 2003 ● Microsoft Windows Server 2008 ● Red Hat Enterprise Linux ● SuSE Linux Enterprise Server ● VMware ESX Server ● HP-UX ● Mac OS For a complete list of currently supported servers, operating systems, host bus adapters, clustering applications, and SAN switches and directors, refer to System Storage Interoperation Center (SSIC).
RAID levels	0, 1, 3, 5, 6, 10.
Storage partitions	Support for up to 128 storage partitions (levels: four standard with upgrades to 8, 16, 32, 64, 128).
Copy services	<ul style="list-style-type: none"> ● IBM FlashCopy® (256) ● Volume Copy (255) ● Remote Mirroring through Fibre Channel host ports (16)
Performance options	Turbo and base performance options.
Fans and power supplies	Dual redundant, hot-swappable Power and cooling module houses power supplies, redundant cooling fans.
Rack support	2U, 19-inch, industry-standard rack.
Management software	IBM System Storage DS® Storage Manager.
SAN support	Supported IBM FC switches and directors, and IP switches.

Table 2. DS3500 specifications (part 2)

Feature	Description
CRUs	All primary components are hot-swappable CRUs and can be accessed easily and removed or replaced.
Warranty	Three-year parts and labor warranty, 9x5 next business day. Upgradeable to 24x7 with 4-hour response.
Other	DC-powered models available in enclosures for twenty-four 2.5-inch drives of (DS3524 and EXP3524).

Figure 2 shows the rear view of the DS3500 with Native SAS host ports only.

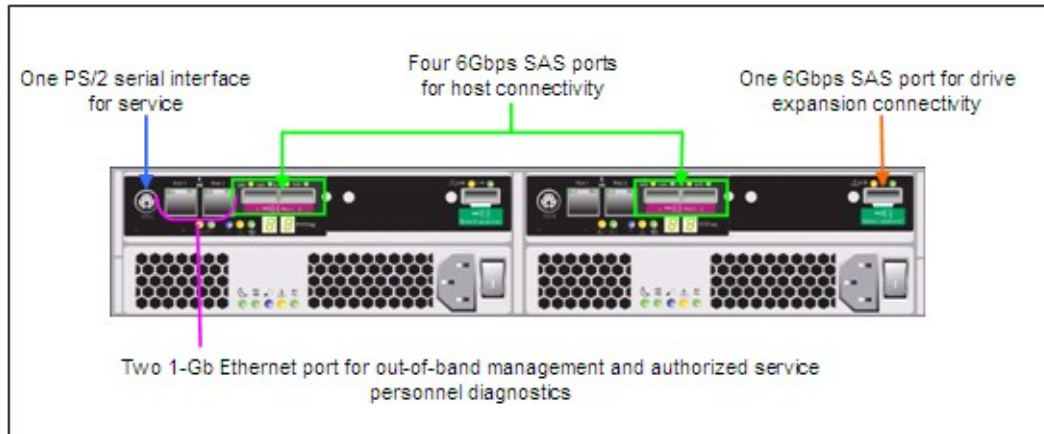

Figure 2. DS3500 rear view

Table 3 lists the physical characteristics of the IBM System Storage DS3500 models.

Table 3. DS3500 physical characteristics

Feature	Description
Dimensions	<ul style="list-style-type: none"> DS3512 and EXP3512: height: 3.39 in./86.16 mm, width: 18.99 in./482.47 mm, depth: 21.72 in./551.60 mm DS3524 and EXP3524: height: 3.47 in./88.07 mm, width: 18.98 in./482.10 mm, depth: 19.60 in./497.93 mm
Weight	<ul style="list-style-type: none"> DS3512 Single controller: 17.2 kg (38.0 lb) DS3512 Dual controller: 18.5 kg (40.7 lb) DS3524 Single controller: 20.2 kg (44.5 lb) DS3542 Dual controller: 21.4 kg (47.2 lb) EXP3512: weight: 16.9 kg (37.3lb) EXP3524: weight: 19.9 kg (43.8lb)
Drive enclosure models	<ul style="list-style-type: none"> 1746-E2A - EXP3512 1746-E4A - EXP3524 Drive interface - 6 Gb SAS.
Temperature	<ul style="list-style-type: none"> Operating: 0 to 35 °C (32 to 95 °F) at 30.5 to 3,000 m (100 to 9,840 ft) Non-operating: -10 to 50 °C (-14 to 120 °F)
Heat dissipation (BTU per hour)	<ul style="list-style-type: none"> DS3512 - 1,307 DS3524 - 1,127
Relative Humidity (no condensation)	<ul style="list-style-type: none"> Operating range: 20 to 80% Storage range: 10 to 90% Maximum dew point: 79 °F (26 °C) Maximum gradient: 10% per hour Applies to EXP3512/EXP3524 Drive Enclosure also.
Altitude ranges	<ul style="list-style-type: none"> Operating: 100 ft (30.5 m) below sea level to 10,000 ft (3048 m) above sea level Storage: 100 ft (30.5 m) below sea level to 10,000 ft (3048 m) above sea level Transit: 100 ft (30.5 m) below sea level to 40,000 ft (12,000 m) above sea level
Acoustical noise emissions	DS3512 and EXP3512 fully populated with 12 drives: <ul style="list-style-type: none"> Sound power (idling): 6.2 bels Sound power (operating): 6.2 bels Sound pressure (idling): 62 dBA Sound pressure (operating): 62 dBA DS3524 and EXP3524 fully populated with 24 drives: <ul style="list-style-type: none"> Sound power (idling): 6.4 bels Sound power (operating): 6.4 bels Sound pressure (idling): 64 dBA Sound pressure (operating): 64 dBA
Electrical input (ac models)	<ul style="list-style-type: none"> Sine-wave input required: 50 - 60 Hz Input voltage low range: 90 - 140 V ac Input voltage high range: 200 - 264 V ac Approximate input kilovolt-amperes(kVA): 0.06 - 0.38 kVA
Electrical input (dc models)	Input voltage range: <ul style="list-style-type: none"> Minimum: -42 V dc Nominal: -48 V dc Maximum: -60 V dc Operating current: 15.3 A to 21.7 A.

EXP3512 and EXP3524 enclosures

Table 4 provides an overview of the IBM System Storage EXP3512 and System Storage EXP3524 Expansion Enclosures shown in Figure 3.

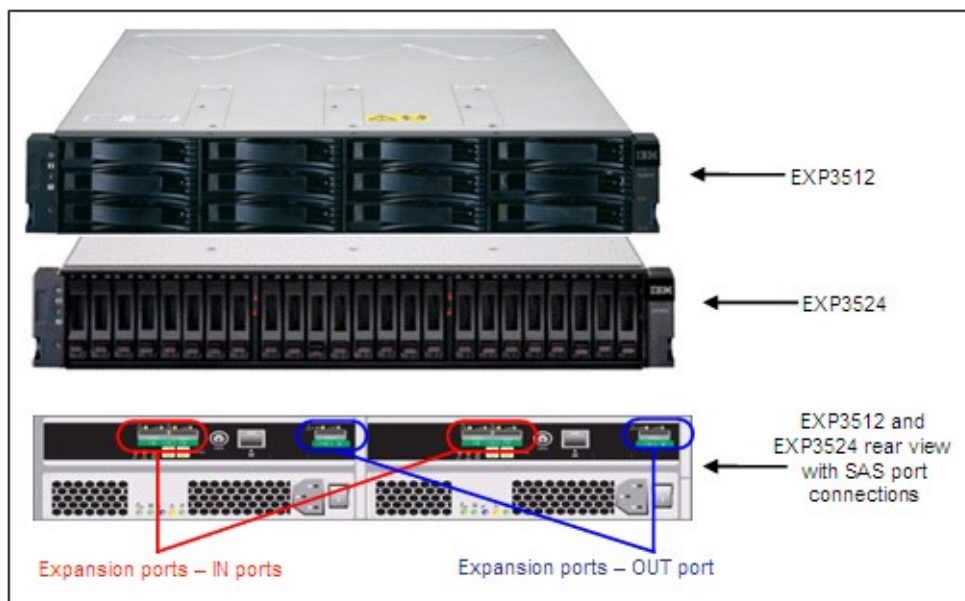

Figure 3. EXP3512 and EXP3524 enclosures

Table 4. Storage expansions (part 1)

Feature	Description
Drive interface	6 Gbps SAS.
Supported drives	<ul style="list-style-type: none"> 6 Gbps SAS 3.5" drives - EXP3512. 6 Gbps SAS 2.5" drives - EXP3524.
Maximum drives supported	<ul style="list-style-type: none"> EXP3512: twelve 3.5-inch drives. EXP3524: twenty-four 2.5-inch drives. Scalability up to 192 drives (optional mix of expansion enclosures).
Fans and power supplies	Dual.
Rack support	Yes, standard.
Warranty	3-year limited warranty , CRU and on-site service, next business day 9x5, service upgrades available.
Size	2U rack-optimized.
Environment	<ul style="list-style-type: none"> Relative humidity: operating range 20 - 80%. Operating altitude: 100 ft (30.5 m) below sea level to 9,840 ft (3000 m) above sea level.
Heat output	<ul style="list-style-type: none"> EXP3512: 945 BTUs/hr. EXP3524: 821 BTUs/hr.
Energy consumption efficiency	80 PLUS efficiency standard.
Next-generation SAS expansion enclosures	<ul style="list-style-type: none"> Affordable entry point with midrange performance and reliability. 6 Gbps x4 wide SAS ports support high bandwidth and random I/O applications.

Table 4. Storage expansions (part 2)

Feature	Description
Scalable up to 192 drives with a mix of EXP3512 and EXP3524 enclosures	<ul style="list-style-type: none"> Start small and grow your configuration as storage demands change. A choice of EXP3512 and EXP3524 allow for flexibility to choose the optimal enclosure based on organizational requirements. <ul style="list-style-type: none"> EXP3512 can offer the highest flexibility with support for a full range of requirements: high capacity and low cost to high-performance critical applications. EXP3524 is ideal for IOPs-intensive applications and energy efficiency requirements with the highest IOPs/watt and 134% improvement in IOPs/U (compared to EXP3000 expansion unit).
Supports high-performance SAS, capacity-optimized SAS drives, and SEDs	<ul style="list-style-type: none"> Multiple drive support can increase efficiencies, which provides large consolidation and virtualization projects while keeping costs low. Support of self-encrypting drives enables relentless data protection.
Redundant and hot-swappable ESMS, power supplies, and drives	<ul style="list-style-type: none"> Key component of a highly available and reliable storage configuration. Support constant access to data 24x7.
Power supplies designed to meet multiple power efficiency standards	Power efficiencies meet green initiatives and reduce overall energy expenditures.

Options and feature codes

Table 5 lists the option numbers and the feature codes of the various cables that can be ordered with the DS3500.

Table 5. Cables

Option number	Feature code	Description
39R6529	3708	1 m SAS Cable
39R6531	3707	3 m SAS Cable
39M5696	5601	1 m Fiber Cable (LC-LC)
39M5697	5605	5 m Fiber Cable (LC-LC)
39M5698	5625	25 m Fiber Cable (LC-LC)

Table 6 lists option numbers and the feature codes of the various upgrade options that can be ordered with the DS3500.

Table 6. Features and upgrades (part 1)

Option number	Feature code	Description
68Y8436	4300	4 to 8 Partition Upgrade
68Y8437	4301	4 to 16 Partition Upgrade
68Y8438	4302	4 to 32 Partition Upgrade
68Y8439	4304	4 to 64 Partition Upgrade
68Y8440	4305	4 to 128 Partition Upgrade

Table 6. Features and upgrades (part 2)

Option number	Feature code	Description
68Y8441	4310	8 to 16 Partition Upgrade
68Y8442	4311	8 to 32 Partition Upgrade
68Y8443	4312	8 to 64 Partition Upgrade
68Y8444	4313	8 to 128 Partition Upgrade
68Y8445	4320	16 to 32 Partition Upgrade
68Y8446	4321	16 to 64 Partition Upgrade
68Y8447	4322	16 to 128 Partition Upgrade
68Y8448	4330	32 to 64 Partition Upgrade
68Y8449	4331	32 to 128 Partition Upgrade
68Y8450	4340	64 to 128 Partition Upgrade
81Y9620	4390	96 to 192 Drive Expansion
69Y2871	4400	Turbo Performance
68Y8490	4410	Full Disk Encryption (FDE)
68Y8451	4420	FlashCopy: Base
68Y8452	4421	FlashCopy: Upgrade to 8 per volume/64 per system
68Y8453	4430	Volume Copy: Base
68Y8454	4440	FlashCopy Base/Volume Copy Base
68Y8455	4450	Remote Mirroring: Base
81Y9622	4451	Remote Mirroring: Upgrade
68Y8458	4700	AIX/VIOS Host Kit
68Y8459	4710	Linux on Power Host Kit
68Y8461	4720	HP-UX Host Kit
94Y8434	4730	Mac OS Host Kit
69Y2909	6313	United States 10A line C13 to NEMA 5-15P (2.8M)
68Y8479	3600	Second Controller
68Y8431	3610	6 Gb SAS 2 Port Daughter Card
68Y8432	3611	8 Gb FC 4 Port Daughter Card
68Y8433	3612	1 Gb iSCSI 4 Port Daughter Card
81Y9613	3613	10 Gb iSCSI 2 Port Card
69Y2876	3620	8 Gb FC SW SFP Transceivers (Pair)
68Y8434	3630	2 GB Cache Upgrade

Table 7 lists option numbers and the feature codes of the various disk drives that can be ordered with the DS3500. The same part numbers also apply to the EXP3500 Expansion units.

Table 7. Disk drives

Option number	Feature code	Description
2.5-inch disk drives		
49Y1841	5205	146 GB 15 k rpm 6 Gb SAS
49Y1836	5210	300 GB 10 k rpm 6 Gb SAS
49Y1952	5250	300 GB 10 k rpm 6 Gb SAS SED
49Y1851	5265	500 GB 7.2 k rpm 6 Gb NL SAS
49Y2048	5220	600 GB 10 k rpm 6 Gb SAS
81Y9915	5225	900 GB 10 k rpm 6 Gb NL SAS
81Y9872	5270	1 TB 7.2 k rpm 6 Gb NL SAS
81Y9903	5500	200 GB SAS SSD
81Y9907	5505	400 GB SAS SSD
3.5-inch disk drives		
49Y1856	5100	300 GB 15 k rpm SAS
49Y1861	5105	450 GB 15 k rpm SAS
49Y1866	5110	600 GB 15 k rpm SAS
49Y1947	5150	600 GB 15 k rpm SAS SED
49Y1876	5165	1 TB 7.2 k rpm NL SAS
49Y1871	5175	2 TB 7.2 k rpm NL SAS
81Y9886	5185	3 TB 7.2 k rpm 6 Gb NL SAS

Ports and host connections

The DS3500 controller has several connection ports for different purposes (Figure 6). It supports three different host interface cards (HIC), also known as daughter cards, for host connections:

- FC
- iSCSI
- SAS

Each of these is shown in the following figures.

Note: Only one type of optional interface can be added to any one DS3500 storage server. Mixing host interface cards between controllers in the same DS3500 is not supported.

Figure 4 shows the connections of a controller without a HIC installed.

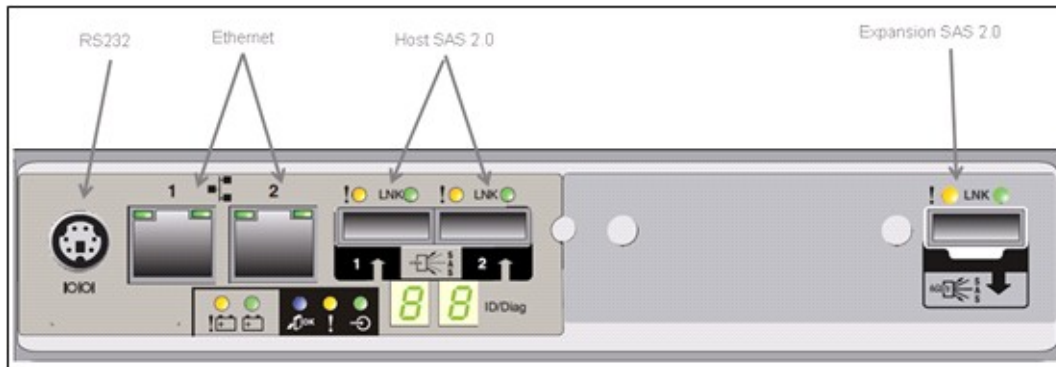

Figure 4. DS3500 controller rear view

Figure 5 shows a rear view of the DS3500 with a SAS daughter card installed. Adding the SAS host interface card simply adds two more SAS 2.0 6 Gbps host ports.



Figure 5. DS3500 controller rear view with SAS daughter card

Figure 6 shows a rear view of the DS3500 with a iSCSI daughter card installed. It is essentially just the base controller with four additional RJ-45 Ethernet ports, all usable for iSCSI traffic.



Figure 6. DS3500 controller rear view with iSCSI daughter card

Figure 7 shows a rear view of the DS3500 with a FC HIC installed, which adds four FC 8 Gbps connections, which can also negotiate at 4 Gbps or 2 Gbps.



Figure 7. DS3500 controller rear view with FC daughter card

Power supplies

Each DS3500 and EXP3500 enclosure comes with two high-efficiency, removable, 585-watt power supplies (Figure 8) as standard. Each power supply has two internal fans for cooling the enclosure. The four fans pull air through the drives from front to back across the drives. The DS3500 meets the Network Equipment Building System (NEBS) and European Telecommunications Standards Institute (ETSI) Telco specification requiring very robust abilities and support for 48 V DC power supplies.

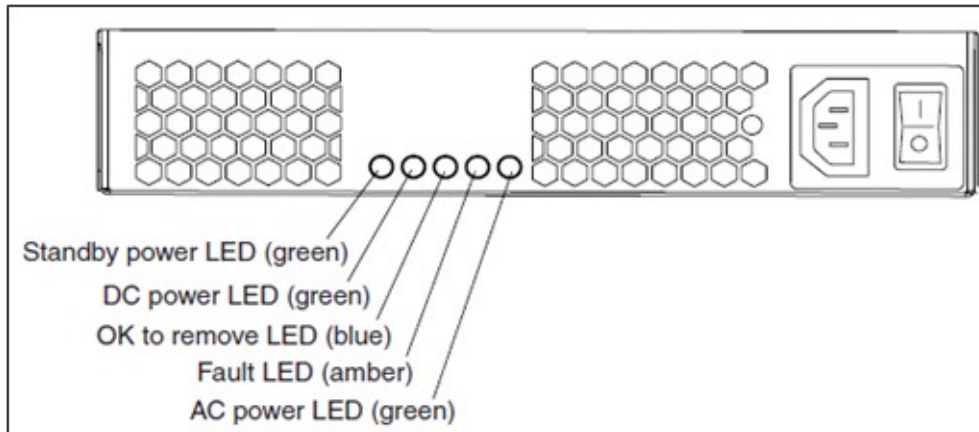

Figure 8. DS3500 power supplies/LED indicators

Fiber Channel cables and connectors

In this section, we discuss essential characteristics of fiber cables and connectors. This information can help you understand the options that you have for connecting and cabling the DS3500 Storage System.

Fiber cables are basically available in multi-mode fiber (MMF) or single-mode fiber (SMF). MMF allows light to disperse in the fiber so that it takes many paths, bouncing off the edge of the fiber repeatedly to finally get to the other end (multi-mode means multiple paths for the light). The light taking these various paths gets to the other end of the cable at slightly separate times (separate paths, separate distances, and separate times). The receiver has to determine which in-coming signals go together.

SMF is so thin (9 microns) that the light can barely “squeeze” through and it tunnels through the center of the fiber using only one path (or mode). This behavior can be explained (although not simply) through the laws of optics and physics. The result is that because there is only one path that the light takes to the receiver, there is no “dispersion confusion” at the receiver. Table 8 lists the supported distances.

Table 8. Cable type overview

Fiber Type	Speed	Maximum distance
9 micron SMF (longwave)	1 Gbps	10 km
9 micron SMF (longwave)	2 Gbps	2 km
50 micron MMF (shortwave)	1 Gbps	500 m
50 micron MMF (shortwave)	2 Gbps	300 m
50 micron MMF (shortwave)	4 Gbps	150 m
50 micron MMF (shortwave)	8 Gbps	50 m
62.5 micron MMF (shortwave)	1 Gbps	300 m
62.5 micron MMF (shortwave)	2 Gbps	150 m
62.5 micron MMF (shortwave)	4 Gbps	70 m
62.5 micron MMF (shortwave)	8 Gbps	21 m

Other feature highlights

This section highlights important features of DS3500 System Storage.

Host connectivity

IBM System Storage DS3500 enables Multi-protocol providing concurrent iSCSI/SAS or FC/SAS host connectivity. Figure 9 shows the two available options.

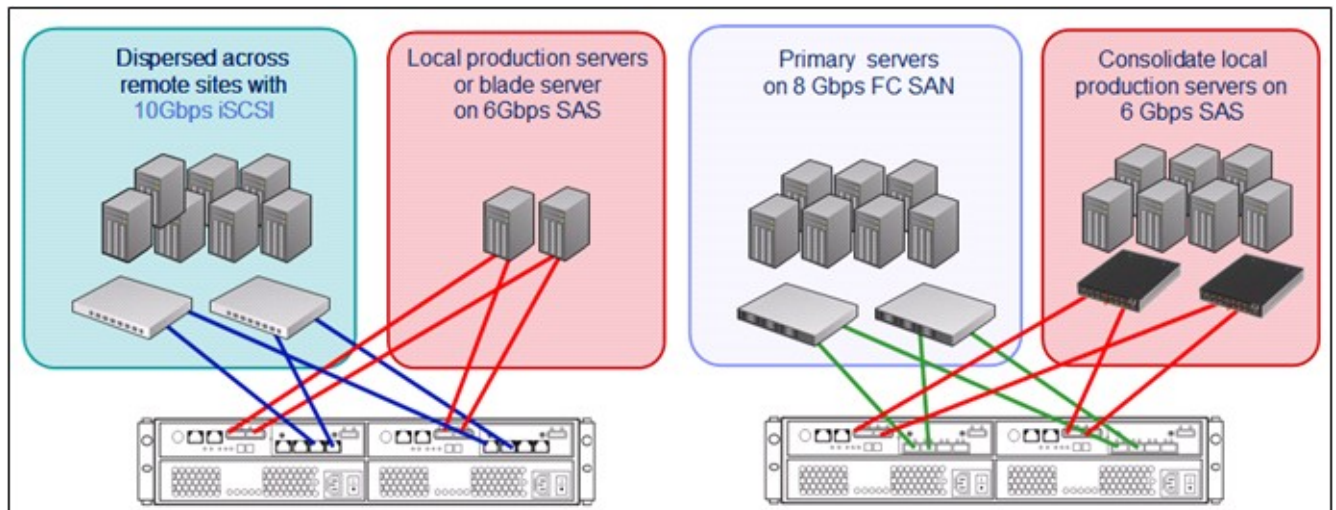

Figure 9. iSCSI/SAS or FC/SAS host connectivity

IBM System Storage DS Storage Manager

The IBM Storage System DS3500 uses the same IBM DS Storage manager as the DS5000 product line and the legacy DS3000 models. Through this software, it is possible to perform administrative tasks such

as creating arrays, logical drives, assigning logical drives to the host servers, setting up FlashCopy and Volume Copy, capturing logs for troubleshooting, and so on. Figure 10 shows the IBM System Storage DS Storage Manager Enterprise Management window.

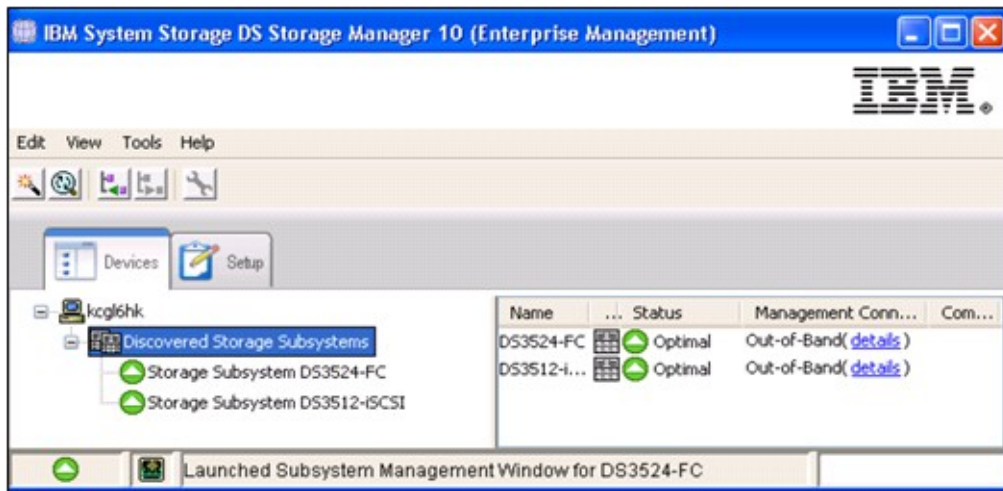

Figure 10. Enterprise Management GUI

Turbo Key

The Turbo Key is an optional premium feature that, when enabled, boosts the performance of a storage system across both throughput and IOP workloads, allowing you to take full advantage of DS3500 performance capabilities with bandwidth-intensive applications. The DS3500 Turbo Key offers:

- Scalability to midrange performance and features starting at entry-level prices
- Efficiencies to help reduce annual energy expenditures and environmental footprint
- Simplicity that does not sacrifice control with the perfect combination of robustness and ease of use

Figure 11 provides a comparison with and without the Turbo Key premium feature enabled.

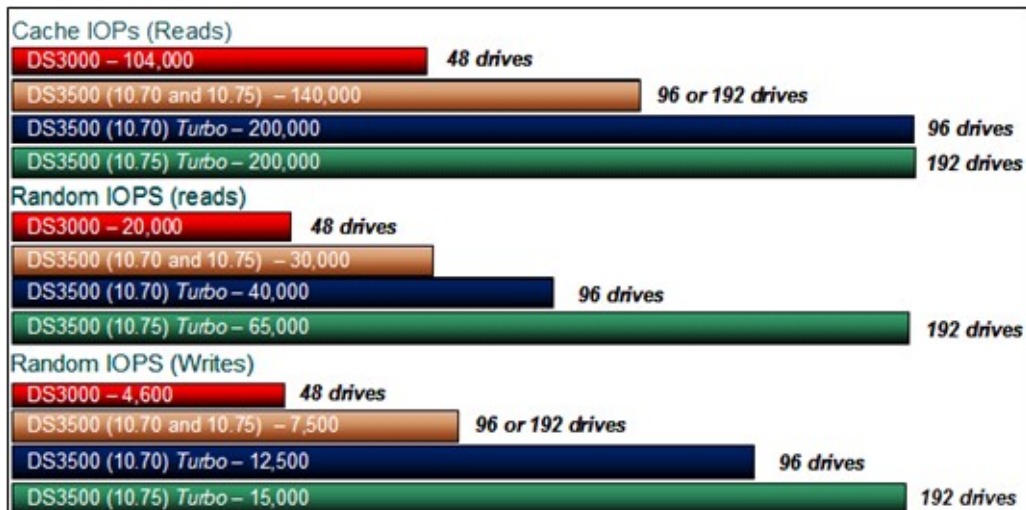

Figure 11. Turbo Key

Storage partitions

Storage partitioning adds a high level of flexibility to the DS3500 Storage System. The DS3500 comes with four partitions by default, which can be expanded to a maximum of 128.

It enables you to connect multiple and heterogeneous host systems to the same storage server, in either stand-alone or clustered mode. The term *storage partitioning* is somewhat misleading because it actually represents a host or a group of hosts and the logical drives that they access. Without storage partitioning, the logical drives configured on a DS3500 Storage System can only be accessed by a single host system or by a single cluster, which can lead to inefficient use of storage server hardware unless the use of the DS3500 Storage System is dedicated to a single host (for example, SVC or v7000 attachment).

FlashCopy

FlashCopy creates a capacity-efficient, point-in-time copy of a physical volume for data protection uses, such as file restoration and backup. A FlashCopy volume is the logical equivalent of the physical volume, but is created more quickly than a physical copy and with minimal disruption to applications and production processes. Using copy-on-write technology, FlashCopy volumes preserve data in its original form even as data in the physical (source) volume is changed. FlashCopy volumes appear and function as standard storage volumes, and restoration of a FlashCopy volume is quick and easy.

FlashCopy Scheduler

With the new FlashCopy Scheduler, it's now possible to schedule FlashCopy images via the user interface. This can be applied to new and existing snapshot volumes. Figure 12 and Figure 13 show the new menu item from the GUI interface.

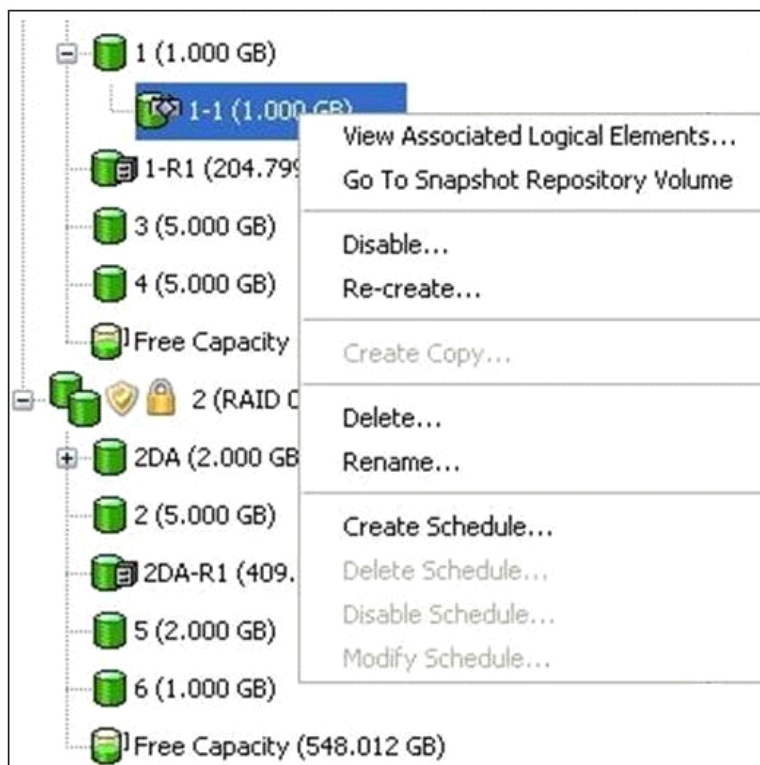

Figure 12. Create Schedule option via GUI Interface

Define the parameters below to create a schedule for the new snapshot volume.

Schedule time

Start time: 12:00 AM Time zone: (GMT-06:00) Central Time (US and Canada)

Schedule recurrence

Number of recreates per day: 1 Time between recreates: 1 hour

Sunday Monday Tuesday Wednesday Thursday Friday Saturday

Select all days

Schedule recurrence range

Start date: Fri 10/1/2010 End date: Fri 10/29/2010 No end date

< Back Next > Cancel Help

Figure 13. Simple and effective menu for scheduling a FlashCopy Image

Volume Copy

The Volume Copy premium feature creates a physical copy of a volume. Volume Copy is used with FlashCopy to create a physical copy of your data with minimal disruption to applications and production processes. Upon completion of the Volume Copy process, the new volume can be mapped to any host, and it functions as a standard volume. Volume Copy can also be used to redistribute data within the DS3500, moving volumes to a different disk drive technology or RAID level. Both FlashCopy and Volume Copy are performed by the DS3500 storage system, so no host server resources are used. A copy can be initiated while the source volume remains available for writes. Figure 14 shows Volume Copy in action.

Source Logical Drive	Target Logical Drive	Status	Timestamp	Priority
RootBoot-Blade1	RootBoot-Blade2	27%		Highest

Total number of copies: 1 Estimated time remaining: 3 minutes Read-only logical drives

Figure 14. Volume manager copying from logical drive RootBoot-Blade1 to RootBoot-Blade2

Graphical performance monitor

The graphical performance monitor provides information about storage I/O from multiple view points. This monitoring tool is very important for performance analysis of a managed storage subsystem. It allows administrator to make informed decisions about storage system adjustments, such as free space usage, locating stranded storage, and efficient provisioning. Figure 15 shows the graphical performance monitor feature in the GUI.

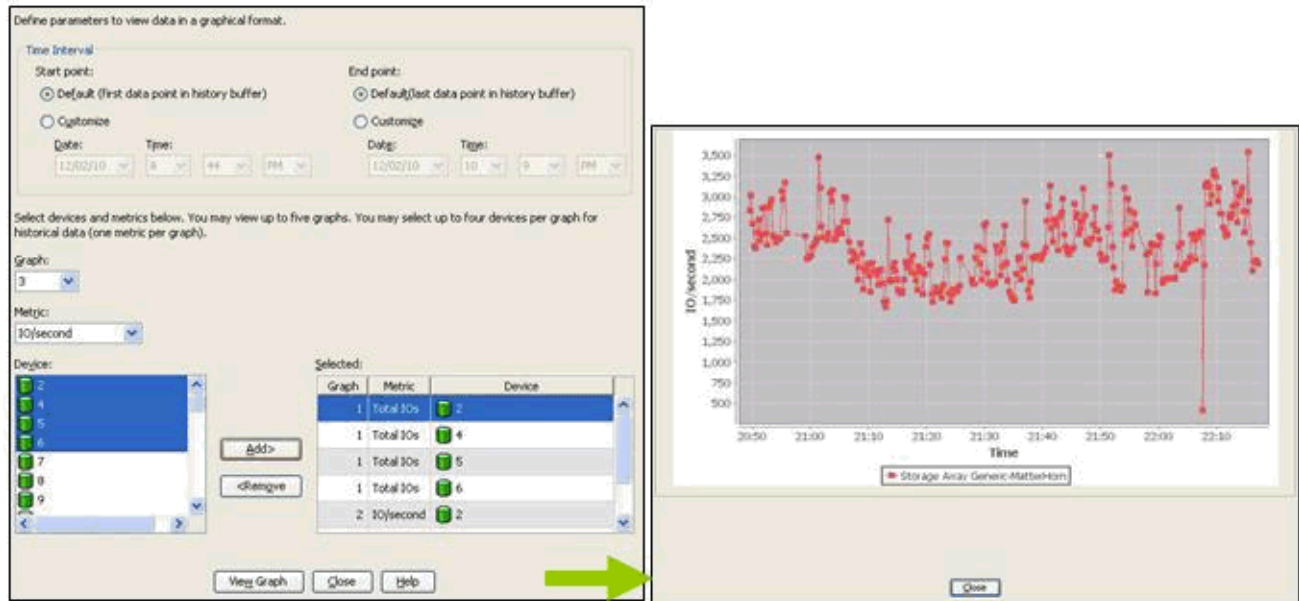

Figure 15. Graphical performance monitor

Full data encryption (FDE)

The SAS SED drives are required to enable disk security and can perform symmetric encryption and decryption of data at full disk speed with no impact on performance. The disk encryption hardware is used in conjunction with IBM Disk Encryption Storage Manager on the DS3500 storage subsystem. It uses asymmetric encryption to encrypt and decrypt the data key. IBM Disk Encryption Storage Manager will generate encryption and decryption keys that are used to lock each SAS SED drive.

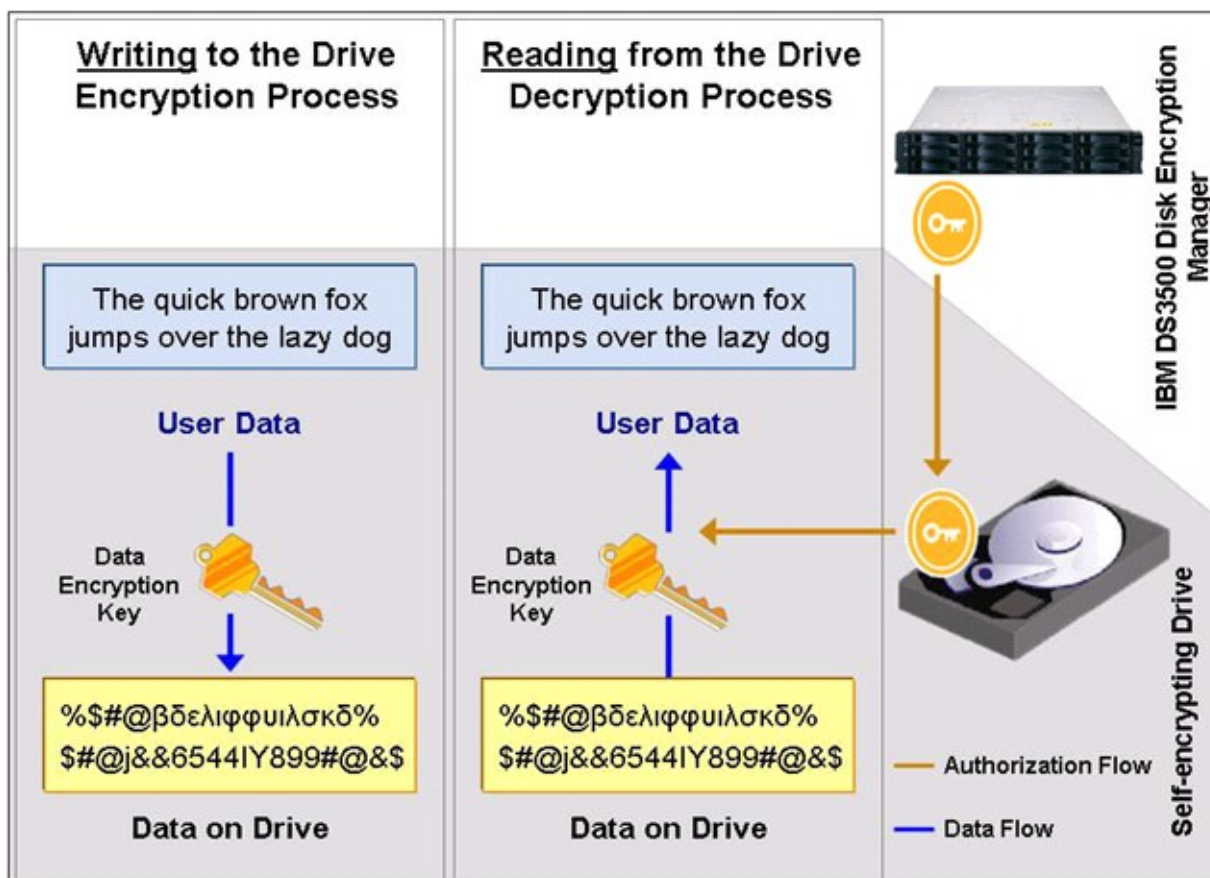

Figure 16. DS3500 disk encryption manager using self-encrypting SAS SED drives

Remote mirroring

Remote mirroring provides storage-system-based data replication from one DS3500 system to another DS3500 system over Fibre Channel communications links. Remote Mirroring supports synchronous or asynchronous data transfers, enabling you to choose the replication method that best meets your protection, distance, or performance requirements:

- Synchronous mirroring is designed to provide continuous mirroring between primary and remote volumes to help ensure absolute synchronization.
- Asynchronous mirroring queues remote writes to reduce the latency, thus enabling long-distance replication while increasing local system performance. Asynchronous mirroring includes a write consistency option designed to ensure that writes to the remote system complete in the same order as the local system.

Remote mirroring also includes features such as dynamic mode switching, suspend and resume with delta resynchronization, read-only and FlashCopy/Volume Copy access to secondary volumes, and cross-mirroring.

IBM RSM for Storage

IBM Remote Support Manager for Storage (RSM for Storage) software is a no-charge software package that is installed on an IBM System x server running Novell SUSE Linux Enterprise Server 9, SUSE Linux Enterprise Server 10, Red Hat Enterprise Linux 4 Advanced Server, or Red Hat Enterprise Linux 5. It

provides problem reporting and remote access for IBM Service for the IBM System Storage DS3000, DS4000, and DS5000 families.

The problem reporting utility provided by RSM for Storage automatically creates an entry in the IBM call management system for each subsystem that reports a problem. This is the equivalent of placing a voice call to IBM Service for a problem. Once in the system, problems are responded to with the priority specified by the maintenance agreement in place for the product.

Interoperability

Table 9 lists the latest operating systems supported by the IBM System Storage DS3500 with the corresponding multipath driver. We suggest checking the IBM System Storage Interoperation center (SSIC):

<http://www-03.ibm.com/systems/support/storage/ssic/interoperability.wss>

Table 9. Latest supported operating systems

Operating systems	Multipath driver
IBM AIX 7.1	IBM MPIO
Novell SUSE Linux Enterprise Server 11 SP1	LSI RDAC
Red Hat Enterprise Linux 6	Linux Device Mapper Multipath LSI RDAC
VMware vSphere/ESX 4.1 U1	Vmware Native Multipathing Plugin (NMP)
Microsoft Windows Server 2008 SP2	Microsoft MPIO (with LSI Device Specific module DSM)
HP HP-UX 11iv3 (11.31)	HP TPGS
IBM VIOS 2.2 with client AIX 7.1 or later	IBM MPIO
IBM VIOS 2.2 with client IBM i 7.1 or later	IBM MPIO
IBM VIOS 2.2 with client Red Hat 6 or later	IBM MPIO
IBM VIOS 2.2 with client SLES 11 or later	IBM MPIO

Host bus adapters

Refer to the IBM System Storage Interoperation Center (SSIC) for compatible HBAs:

<http://www-03.ibm.com/systems/support/storage/ssic/interoperability.wss>

Drivers and firmware downloads

Fix Central provides fixes and updates for your system's software, hardware, and operating system. To download fixes, drivers, and firmware for the IBM System Storage DS3500, select the corresponding fields on the following IBM website:

<http://www-933.ibm.com/support/fixcentral/>

Product Group
Storage Systems

Product Family
Disk Systems

Product
DS3500 (DS3512, DS3524)

Release
Select one

Continue

Figure 17. IBM Support: Fix Central

Disk attachment

This section describes the requirements and best practice guidelines for connecting EXP3500 enclosures to a DS3500 storage subsystem.

Figure 18 shows the SAS connections between a single controller DS3500 subsystem and three EXP3500 enclosures, with a single ESM installed in each EXP3500. This configuration is a fully functional configuration, but there is no redundancy on the drive-side connections.

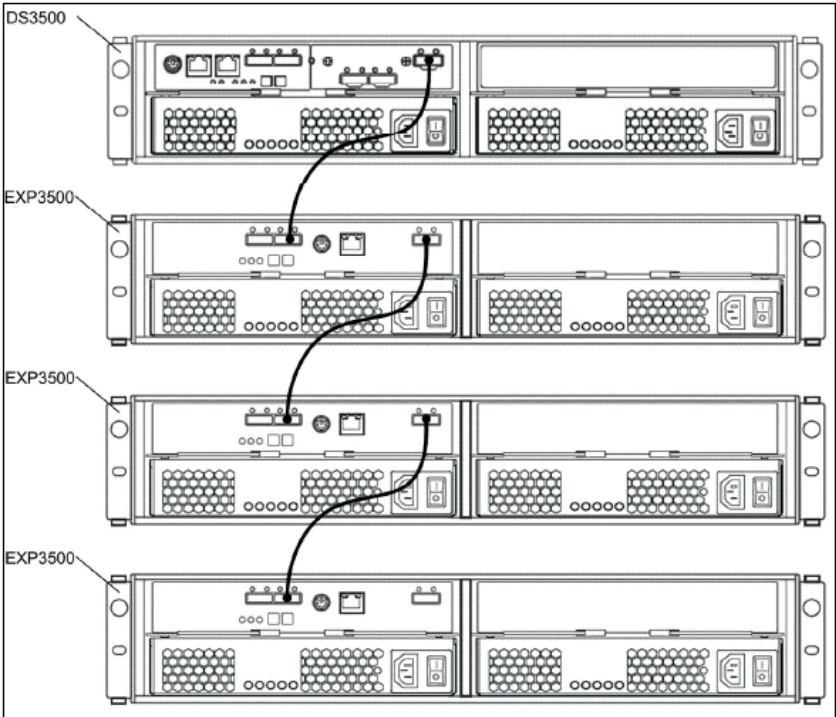

Figure 18. Single controller attachment

Figure 19 shows how to correctly cable a dual controller DS3500 to a single EXP3500 enclosure with two ESMS installed. This configuration provides redundancy on the drive-side connections.

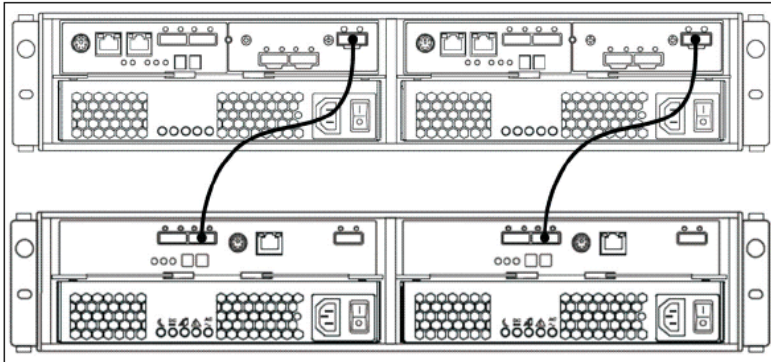

Figure 19. Dual controller attachment

Figure 20 shows the SAS cable connections when using the top-down/bottom-up cabling layout with the DS3500 storage subsystem at the top. This is the preferred SAS expansion cabling for when you are connecting two or more EXP3500 enclosures, up to the supported maximum of eight EXP3500 enclosures.

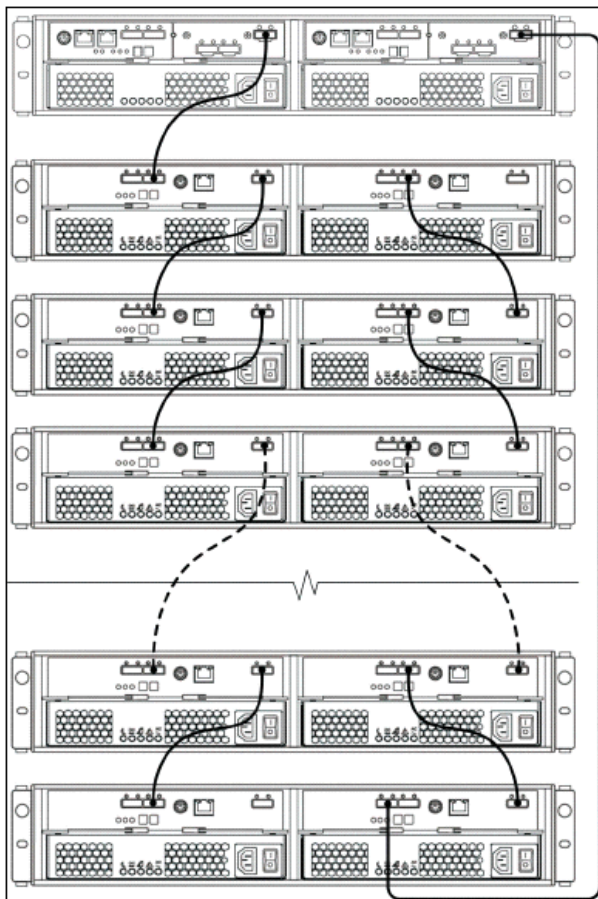

Figure 20. Top-down/bottom-up SAS drive-side connections

Host attachment

This section outlines the supported topologies for a DS3500 considering FC, iSCSI, and SAS connections. There are examples for both single and dual controller DS3500 storage subsystems.

- General rule: Although some of the examples shown next are valid supported configurations, there are some with no redundancy of host-side connections. Always use redundant host-side connections instead.
- FC direct attachment: The DS3500 storage subsystem supports both direct attached and SAN fabric attached hosts. You can attach up to four direct-connected hosts or up to 64 host servers in a switched fabric SAN infrastructure. This section describes sample configurations of direct-attached Fibre Channel host servers.
- SAS connections: Host server SAS HBAs are used to connect to the DS3500 SAS ports. Each DS3500 controller can have up to four SAS host ports when you install the optional SAS host interface adapter. When the optional SAS host interface adapter is installed, the DS3500 can support up to 28 Blade Center hosts when attached to the SAS Connectivity Module for IBM Blade Center and up to four hosts in a direct attached host environment.

Topologies

The DS3500 supports multiple-host, multiple-port, and multiple-fabric (Fibre Channel or iSCSI, and SAS) configurations. That is, the DS3500 storage subsystem supports simultaneous SAS and either iSCSI or Fibre Channel host connections with the optional iSCSI or Fibre Channel host adapter installed, up to a maximum of 64 hosts. Figure 21 shows an example of this type of configuration with one SAS attachment and one iSCSI or FC host.

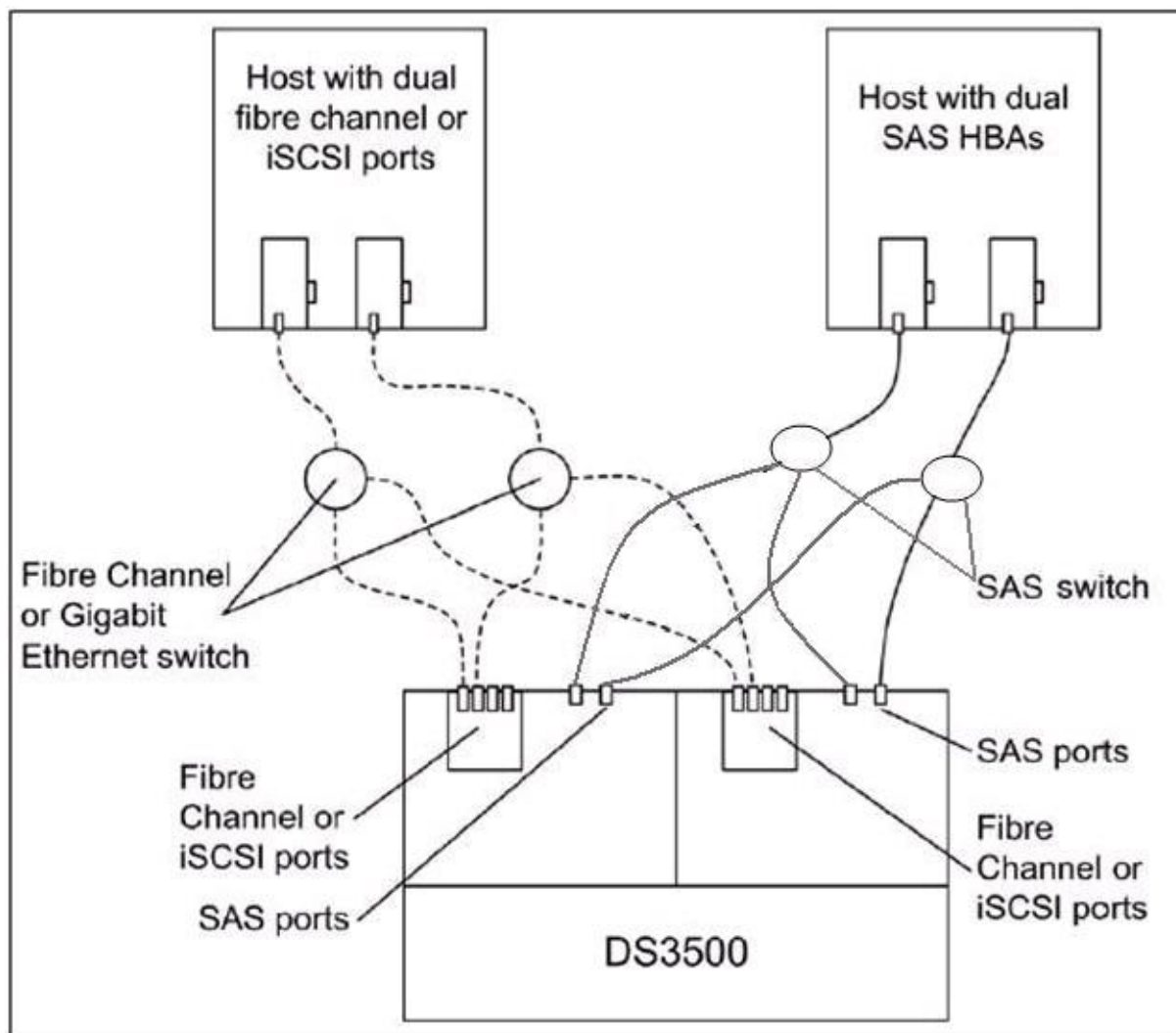

Figure 21. Host connections

Warranty period and warranty service

Every DS3500 is covered by the below warranty:

- System (including the cache backup battery module): three years
- Optional features: three years, unless specified otherwise

Optional IBM features initially installed in an IBM system carry the same warranty and warranty service support category as the system. If installed after the initial system installation, they carry the balance of the system warranty or the optional feature warranty, whichever is greater.

Customer replaceable unit (CRU) service

IBM provides replacement CRUs to you for you to install. CRU information and replacement instructions are shipped with your machine and are available from IBM upon your request.

Table 10 lists the various warranty options for different models of the DS3500 System Storage.

Table 10. Warranties

ServicePac®	DS3512*	EXP3512	DS3524*	EXP3524	DS3524 DC Power**	EXP3524 DC Power
Part number	1746A2S 1746A2D	1746A2E	1746A4S 1746A4D	1746A4E	1746T4D	1746T4E
Warranty and maintenance option						
3-year onsite repair 24x7 2-hour response	88Y8187	88Y8213	88Y8200	88Y8226	N/A	N/A
3-year onsite repair 24x7 4-hour response	88Y8186	88Y8212	88Y8199	88Y8225	N/A	N/A
3-year onsite repair 9x5 4-hour response	88Y8185	88Y8211	88Y8198	88Y8224	N/A	N/A
5-year onsite repair 24x7 2-hour response	88Y8189	88Y8215	88Y8202	88Y8228	N/A	N/A
5-year onsite repair 24x7 4-hour response	88Y8188	88Y8214	88Y8201	88Y8227	N/A	N/A
Maintenance agreement						
1-year onsite repair 24x7 2-hour response	88Y8193	88Y8219	88Y8206	88Y8232	N/A	N/A
1-year onsite repair 24x7 4-hour response	88Y8192	88Y8218	88Y8205	88Y8231	N/A	N/A
1-year onsite repair 9x5 4-hour response	88Y8191	88Y8217	88Y8204	88Y8230	N/A	N/A
1-year onsite repair 9x5 next business day	88Y8190	88Y8216	88Y8203	88Y8229	N/A	N/A
2-year onsite repair 24x7 2-hour response	88Y8197	88Y8223	88Y8210	88Y8236	N/A	N/A
2-year onsite repair 24x7 4-hour response	88Y8196	88Y8222	88Y8209	88Y8235	N/A	N/A
2-year onsite repair 9x5 4-hour response	88Y8195	88Y8221	88Y8208	88Y8234	N/A	N/A
2-year onsite repair 9x5 next business day	88Y8194	88Y8220	88Y8207	88Y8233	N/A	N/A
Remote technical support						
RTS for Storage Devices - Base - 1yr	29R5810	29R5810	29R5810	29R5810	29R5810	29R5810
RTS for Storage Devices - Base - 3yr	41W9377	41W9377	41W9377	41W9377	41W9377	41W9377

* for both single and dual controller

**for dual controller

Note: Each ServicePac is country specific and is only valid when purchased and registered in the country in which IBM service will be provided. Refer to the IBM ServicePac - Worldwide Product Matrix at the URL below for a complete list of the ServicePac part numbers specific to your country:

<https://www-304.ibm.com/sales/gss/download/spst/servicepac/extProductSelectorWWW.do>

Related publications and links

For more information refer to the following resources:

- IBM Systems Storage DS3500 - Product Page
<http://www-03.ibm.com/systems/storage/disk/ds3500/index.html>
- IBM Systems Storage DS3500 - Data Sheet
<http://public.dhe.ibm.com/common/ssi/ecm/en/tsd03097usen/TSD03097USEN.PDF>
- IBM System Storage DS3500 - New disk drives announcement (August 30, 2011)
<http://ibm.com/common/ssi/cgi-bin/ssialias?infotype=dd&subtype=ca&&htmlfid=897/ENUS111-149>
- IBM Systems Storage DS3500 - 10Gb iSCSI Announcement (May 9, 2011)
<http://ibm.com/common/ssi/cgi-bin/ssialias?infotype=dd&subtype=ca&&htmlfid=897/ENUS111-102>
- IBM Systems Storage DS3500 - Product Announcement (May 18, 2010)
<http://ibm.com/common/ssi/cgi-bin/ssialias?infotype=dd&subtype=ca&&htmlfid=897/ENUS110-101>
- IBM System Storage Interoperation Center (SSIC)
<http://www-03.ibm.com/systems/support/storage/ssic/interoperability.wss>
- *IBM Systems Storage DS3500 and EXP3500 Rack Installation and Quick Start Guide*
<http://ibm.com/support/entry/portal/docdisplay?Indocid=MIGR-5084407>
- *IBM Systems Storage DS3500 and EXP3500 Installation, User's, and Maintenance Guide*
<http://ibm.com/support/entry/portal/docdisplay?Indocid=MIGR-5084732>
- *IBM System Storage DS Storage Manager Version 10 Installation and Host Support Guide*
<http://www.ibm.com/support/entry/portal/docdisplay?Indocid=MIGR-5075652>
- *IBM System Storage DS Storage Manager Version 10.70 Copy Services User's Guide*
<http://www.ibm.com/support/entry/portal/docdisplay?Indocid=MIGR-61173>
- *IBM System Storage DS3000, DS4000, and DS5000 Command Line Interface and Script Commands Programming Guide*
<http://www.ibm.com/support/entry/portal/docdisplay?Indocid=MIGR-5076792>
- *IBM System Storage DS3000, DS4000, and DS5000 Hard Disk Drive and Storage Expansion Enclosure Installation and Migration Guide*
<http://www.ibm.com/support/entry/portal/docdisplay?Indocid=MIGR-57818>
- *IBM Remote Support Manager Version 2.6 Planning, Installation, and User's Guide*
<http://www.ibm.com/support/entry/portal/docdisplay?Indocid=MIGR-66062>
- *IBM System Storage DS3500 Introduction and Implementation Guide*, SG24-7914
<http://www.redbooks.ibm.com/abstracts/sg247914.html?Open>
- *IBM System Storage DS Storage Manager Copy Services Guide*, SG24-7822
<http://www.redbooks.ibm.com/abstracts/sg247822.html?Open>

Notices

This information was developed for products and services offered in the U.S.A.

IBM may not offer the products, services, or features discussed in this document in other countries. Consult your local IBM representative for information on the products and services currently available in your area. Any reference to an IBM product, program, or service is not intended to state or imply that only that IBM product, program, or service may be used. Any functionally equivalent product, program, or service that does not infringe any IBM intellectual property right may be used instead. However, it is the user's responsibility to evaluate and verify the operation of any non-IBM product, program, or service. IBM may have patents or pending patent applications covering subject matter described in this document. The furnishing of this document does not give you any license to these patents. You can send license inquiries, in writing, to:

IBM Director of Licensing, IBM Corporation, North Castle Drive, Armonk, NY 10504-1785 U.S.A.

The following paragraph does not apply to the United Kingdom or any other country where such provisions are inconsistent with local law: INTERNATIONAL BUSINESS MACHINES CORPORATION PROVIDES THIS PUBLICATION "AS IS" WITHOUT WARRANTY OF ANY KIND, EITHER EXPRESS OR IMPLIED, INCLUDING, BUT NOT LIMITED TO, THE IMPLIED WARRANTIES OF NON-INFRINGEMENT, MERCHANTABILITY OR FITNESS FOR A PARTICULAR PURPOSE. Some states do not allow disclaimer of express or implied warranties in certain transactions, therefore, this statement may not apply to you. This information could include technical inaccuracies or typographical errors. Changes are periodically made to the information herein; these changes will be incorporated in new editions of the publication. IBM may make improvements and/or changes in the product(s) and/or the program(s) described in this publication at any time without notice.

Any references in this information to non-IBM Web sites are provided for convenience only and do not in any manner serve as an endorsement of those Web sites. The materials at those Web sites are not part of the materials for this IBM product and use of those Web sites is at your own risk. IBM may use or distribute any of the information you supply in any way it believes appropriate without incurring any obligation to you. Information concerning non-IBM products was obtained from the suppliers of those products, their published announcements or other publicly available sources. IBM has not tested those products and cannot confirm the accuracy of performance, compatibility or any other claims related to non-IBM products. Questions on the capabilities of non-IBM products should be addressed to the suppliers of those products. This information contains examples of data and reports used in daily business operations. To illustrate them as completely as possible, the examples include the names of individuals, companies, brands, and products. All of these names are fictitious and any similarity to the names and addresses used by an actual business enterprise is entirely coincidental.

Any performance data contained herein was determined in a controlled environment. Therefore, the results obtained in other operating environments may vary significantly. Some measurements may have been made on development-level systems and there is no guarantee that these measurements will be the same on generally available systems. Furthermore, some measurement may have been estimated through extrapolation. Actual results may vary. Users of this document should verify the applicable data for their specific environment.

COPYRIGHT LICENSE:

This information contains sample application programs in source language, which illustrate programming techniques on various operating platforms. You may copy, modify, and distribute these sample programs in any form without payment to IBM, for the purposes of developing, using, marketing or distributing application programs conforming to the application programming interface for the operating platform for which the sample programs are written. These examples have not been thoroughly tested under all conditions. IBM, therefore, cannot guarantee or imply reliability, serviceability, or function of these programs.

© Copyright International Business Machines Corporation 2011. All rights reserved.

Note to U.S. Government Users Restricted Rights -- Use, duplication or disclosure restricted by GSA ADP Schedule Contract with IBM Corp.

This document was created or updated on September 9, 2011.

Send us your comments in one of the following ways:

- Use the online **Contact us** review form found at:
ibm.com/redbooks
- Send your comments in an e-mail to:
redbook@us.ibm.com
- Mail your comments to:
IBM Corporation, International Technical Support Organization
Dept. HYTD Mail Station P099
2455 South Road
Poughkeepsie, NY 12601-5400 U.S.A.

This document is available online at <http://www.ibm.com/redbooks/abstracts/tips0836.html> .

Trademarks

IBM, the IBM logo, and ibm.com are trademarks or registered trademarks of International Business Machines Corporation in the United States, other countries, or both. These and other IBM trademarked terms are marked on their first occurrence in this information with the appropriate symbol (® or ™), indicating US registered or common law trademarks owned by IBM at the time this information was published. Such trademarks may also be registered or common law trademarks in other countries. A current list of IBM trademarks is available on the Web at <http://www.ibm.com/legal/copytrade.shtml>

The following terms are trademarks of the International Business Machines Corporation in the United States, other countries, or both:

AIX®
BladeCenter®
DS4000®
Express Storage™
FlashCopy®
IBM®
Power Systems™
POWER®
Redbooks (logo)®
ServicePac®
System Storage DS®
System Storage®
System x®

The following terms are trademarks of other companies:

Microsoft, Windows, and the Windows logo are trademarks of Microsoft Corporation in the United States, other countries, or both.

Intel, Intel logo, Intel Inside, Intel Inside logo, Intel Centrino, Intel Centrino logo, Celeron, Intel Xeon, Intel SpeedStep, Itanium, and Pentium are trademarks or registered trademarks of Intel Corporation or its subsidiaries in the United States and other countries.

Linux is a trademark of Linus Torvalds in the United States, other countries, or both.

Other company, product, or service names may be trademarks or service marks of others.

