



Sun StorEdge™ 3000 Family Installation, Operation, and Service Manual

Sun StorEdge 3120 SCSI Array

Sun Microsystems, Inc.
www.sun.com

Part No. 816-7956-11
July 2004, Revision A

Submit comments about this document at: <http://www.sun.com/hwdocs/feedback>

Copyright © 2004 Dot Hill Systems Corporation, 6305 El Camino Real, Carlsbad, California 92009, USA. All rights reserved.

Sun Microsystems, Inc. and Dot Hill Systems Corporation may have intellectual property rights relating to technology embodied in this product or document. In particular, and without limitation, these intellectual property rights may include one or more of the U.S. patents listed at <http://www.sun.com/patents> and one or more additional patents or pending patent applications in the U.S. and other countries.

This product or document is distributed under licenses restricting its use, copying distribution, and decompilation. No part of this product or document may be reproduced in any form by any means without prior written authorization of Sun and its licensors, if any.

Third-party software is copyrighted and licensed from Sun suppliers.

Parts of the product may be derived from Berkeley BSD systems, licensed from the University of California. UNIX is a registered trademark in the U.S. and in other countries, exclusively licensed through X/Open Company, Ltd.

Sun, Sun Microsystems, the Sun logo, Sun StorEdge, AnswerBook2, docs.sun.com, and Solaris are trademarks or registered trademarks of Sun Microsystems, Inc. in the U.S. and in other countries.

U.S. Government Rights—Commercial use. Government users are subject to the Sun Microsystems, Inc. standard license agreement and applicable provisions of the FAR and its supplements.

DOCUMENTATION IS PROVIDED "AS IS" AND ALL EXPRESS OR IMPLIED CONDITIONS, REPRESENTATIONS AND WARRANTIES, INCLUDING ANY IMPLIED WARRANTY OF MERCHANTABILITY, FITNESS FOR A PARTICULAR PURPOSE OR NON-INFRINGEMENT, ARE DISCLAIMED, EXCEPT TO THE EXTENT THAT SUCH DISCLAIMERS ARE HELD TO BE LEGALLY INVALID.

Copyright © 2004 Dot Hill Systems Corporation, 6305 El Camino Real, Carlsbad, Californie 92009, Etats-Unis. Tous droits réservés.

Sun Microsystems, Inc. et Dot Hill Systems Corporation peuvent avoir les droits de propriété intellectuels relatants à la technologie incorporée dans le produit qui est décrit dans ce document. En particulier, et sans la limitation, ces droits de propriété intellectuels peuvent inclure un ou plus des brevets américains énumérés à <http://www.sun.com/patents> et un ou les brevets plus supplémentaires ou les applications de brevet en attente dans les Etats-Unis et dans les autres pays.

Ce produit ou document est protégé par un copyright et distribué avec des licences qui en restreignent l'utilisation, la copie, la distribution, et la décompilation. Aucune partie de ce produit ou document ne peut être reproduite sous aucune forme, par quelque moyen que ce soit, sans l'autorisation préalable et écrite de Sun et de ses bailleurs de licence, s'il y ena.

Le logiciel détenu par des tiers, et qui comprend la technologie relative aux polices de caractères, est protégé par un copyright et licencié par des fournisseurs de Sun.

Des parties de ce produit pourront être dérivées des systèmes Berkeley BSD licenciés par l'Université de Californie. UNIX est une marque déposée aux Etats-Unis et dans d'autres pays et licenciée exclusivement par X/Open Company, Ltd.

Sun, Sun Microsystems, le logo Sun, Sun StorEdge, AnswerBook2, docs.sun.com, et Solaris sont des marques de fabrique ou des marques déposées de Sun Microsystems, Inc. aux Etats-Unis et dans d'autres pays.

LA DOCUMENTATION EST FOURNIE "EN L'ÉTAT" ET TOUTES AUTRES CONDITIONS, CONDITIONS, DECLARATIONS ET GARANTIES EXPRESSES OU TACITES SONT FORMELLEMENT EXCLUES, DANS LA MESURE AUTORISEE PAR LA LOI APPLICABLE, Y COMPRIS NOTAMMENT TOUTE GARANTIE IMPLICITE RELATIVE A LA QUALITE MARCHANDE, A L'APTITUDE A UNE UTILISATION PARTICULIERE OU A L'ABSENCE DE CONTREFAÇON.



Please
Recycle



Adobe PostScript

Contents

Preface ix

1. Array Overview 1-1

- 1.1 Introducing the Array Model 1-1
- 1.2 Best Practices for the Sun StorEdge 3120 SCSI Array 1-2
 - 1.2.1 Entry-level Server Storage Requirements 1-3
 - 1.2.2 Print Server Architecture and Configuration 1-3
 - 1.2.2.1 Tips and Techniques 1-5
 - 1.2.3 File Server Architecture and Configuration 1-5
 - 1.2.4 Application Server Architecture and Configuration 1-6
- 1.3 Additional Software Tools 1-8

2. Site Planning 2-1

- 2.1 Customer Obligations 2-2
- 2.2 Safety Precautions 2-2
- 2.3 Environmental Requirements 2-3
- 2.4 Electromagnetic Compatibility (EMC) 2-4
- 2.5 Electrical and Power Specifications 2-4
- 2.6 Physical Specifications 2-5
- 2.7 Layout Map 2-5

- 2.8 Rack Placement 2-6
- 2.9 Preinstallation Worksheet 2-6

- 3. Inspecting the Array Package 3-1**
 - 3.1 Unpacking the Array 3-1
 - 3.2 Checking the Package Contents 3-2
 - 3.3 Field-Replaceable Units 3-3
 - 3.4 Customer-Provided Cables 3-3

- 4. Connecting Your SCSI Array 4-1**
 - 4.1 Converting Your Front Bezel Locks So the Keys Cannot Be Removed 4-2
 - 4.2 Rackmounting the Array 4-4
 - 4.3 Connecting Chassis to an AC Power Outlet 4-4
 - 4.4 Connecting the Chassis to DC Power Outlets 4-6
 - 4.5 Bus and Cable Lengths 4-7
 - 4.6 Connecting Sun StorEdge 3120 SCSI Arrays to Hosts 4-8
 - 4.6.1 Single-Bus (SB) Label 4-9
 - 4.6.2 Fixed Drive IDs 4-10
 - 4.6.3 Connecting Cables for a Single-Bus Configuration 4-11
 - 4.6.4 A Single-Bus JBOD with One Host Connection 4-12
 - 4.6.5 A Single-Bus, Multi-Initiator JBOD Configuration 4-14
 - 4.6.6 A Split-Bus, Single-Initiator JBOD Configuration 4-15
 - 4.6.7 A Split-Bus, Multi-Initiator JBOD Configuration Connected to One JBOD 4-18

- 5. Software Management Tools 5-1**
 - 5.1 Overview of Provided Software 5-1
 - 5.2 Monitoring with the Sun StorEdge Configuration Service 5-2
 - 5.2.1 Enabling JBOD Support 5-2
 - 5.2.2 Viewing Component and Alarm Characteristics 5-4

- 5.3 Event Messages from the Sun StorEdge Diagnostic Reporter 5-6
- 5.4 Monitoring with the Sun StorEdge CLI 5-7
 - about 5-7
 - exit 5-7
 - help 5-8
 - quit 5-8
 - select 5-8
 - set led 5-9
 - show configuration 5-10
 - show enclosure-status 5-12
 - show frus 5-13
 - show inquiry-data 5-15
 - show led-status 5-15
 - show safte-devices 5-16
 - version 5-17
- 5.5 Managing Disks in the Sun StorEdge 3120 SCSI Array 5-17
- 5.6 Enabling VERITAS DMP in a Single-Bus Configuration 5-17
- 6. Checking LEDs 6-1**
 - 6.1 LEDs When Array Is First Powered On 6-1
 - 6.2 Front-Panel LEDs 6-2
 - 6.3 Back-Panel LEDs 6-4
- 7. Maintaining and Troubleshooting Your Array 7-1**
 - 7.1 Upgrading Firmware 7-2
 - 7.2 Failed Component Alarms 7-2
 - 7.3 Silencing Audible Alarms 7-3
 - 7.4 General Troubleshooting Guidelines 7-4
 - 7.4.1 Writing Events to a Log File for an IBM AIX Host 7-5

- 7.5 Troubleshooting Solaris Operating System Configuration Issues 7-6
- 7.6 JBOD Disks Not Visible to the Host 7-6
 - 7.6.1 Making JBODs Visible to Hosts Running the Solaris Operating System 7-7
 - 7.6.2 Making JBODs Visible to Hosts Running the Windows NT Operating System 7-7
 - 7.6.3 Making JBODs Visible to Hosts Running the Windows 2000 and Windows 2003 Operating Systems 7-10
 - 7.6.4 Making JBODs Visible to Hosts Running the Linux Operating System 7-14
 - 7.6.5 Making JBODs Visible to Hosts Running the HP-UX Operating System 7-15
 - 7.6.6 Making JBODs Visible to Hosts Running the IBM AIX Operating System 7-15
- 7.7 Identifying a Failed Drive for Replacement 7-17
 - 7.7.1 Verifying Operating System Device Information 7-17
- 7.8 JBOD Troubleshooting Decision Trees 7-19

8. Installing FRUs 8-1

- 8.1 Available FRUs 8-1
- 8.2 Static Electricity and Other Precautions 8-2
- 8.3 Disk Drive and Air Management Sled FRUs 8-3
 - 8.3.1 Replacing a Disk Drive 8-4
 - 8.3.1.1 Identifying the Defective Disk Drive 8-4
 - 8.3.1.2 Removing a Defective Disk Drive 8-5
 - 8.3.1.3 Installing a New Disk Drive 8-6
 - 8.3.2 Installing an Air Management Sled 8-7
- 8.4 Power and Fan Module FRUs 8-7
 - 8.4.1 Replacing an AC Power Supply/Fan Module 8-8
 - 8.4.1.1 Removing an AC Power Supply/Fan Module 8-8
 - 8.4.1.2 Installing an AC Power Supply/Fan Module 8-8

8.4.2	Replacing a DC Power Supply/Fan Module	8-9
8.4.2.1	Removing a DC Power Supply/Fan Module	8-9
8.4.2.2	Installing an DC Power Supply/Fan Module	8-10
8.5	Installing a JBOD Chassis FRU	8-11
A.	SCSI Array Specifications	A-1
A.1	Summary of Physical Specifications	A-2
A.2	Summary of Sun StorEdge 3120 SCSI Array Specifications	A-3
A.3	Agency Approvals and Standards	A-4
A.4	SCSI Host or Drive Connector	A-6
A.5	SCSI Host or Drive Cable	A-7
Index	Index-1	

Preface

This manual provides instructions for installing, initially configuring, and operating your Sun StorEdge™ 3120 SCSI array.



Caution – You should read the *Sun StorEdge 3000 Family Safety, Regulatory, and Compliance Manual* before beginning any procedure in this manual.

How This Book Is Organized

This book contains the following topics:

[Chapter 1](#) provides an overview of the array's features.

[Chapter 2](#) covers the site planning and basic safety requirements.

[Chapter 3](#) provides general procedures for unpacking and inspecting the array.

[Chapter 4](#) provides procedures for connecting your array to power and to the network.

[Chapter 5](#) provides procedures for configuring your array with software management tools.

[Chapter 6](#) describes the array's front and back panel LEDs.

[Chapter 7](#) describes maintenance and troubleshooting procedures.

[Chapter 8](#) provides instructions for removing and installing field-replaceable units (FRUs) in Sun StorEdge 3120 SCSI arrays.

[Appendix A](#) provides Sun StorEdge 3120 SCSI array specifications.

Using UNIX Commands

This document might not contain information on basic UNIX® commands and procedures such as shutting down the system, booting the system, and configuring devices. See the following for this information:

See one or more of the following for this information:

- *Solaris Handbook for Sun Peripherals*
- AnswerBook2™ online documentation for the Solaris™ operating environment
- Software documentation that you received with your system
- Solaris™ operating environment documentation, which is at:

<http://docs.sun.com>

Shell Prompts

Shell	Prompt
C shell	<i>machine-name%</i>
C shell superuser	<i>machine-name#</i>
Bourne shell and Korn shell	\$
Bourne shell and Korn shell superuser	#

Typographic Conventions

Typeface*	Meaning	Examples
AaBbCc123	The names of commands, files, and directories; on-screen computer output	Edit your <code>.login</code> file. Use <code>ls -a</code> to list all files. % You have mail.
AaBbCc123	What you type, when contrasted with on-screen computer output	% su password:
AaBbCc123	Book titles, new words or terms, words to be emphasized. Replace command-line variables with real names or values.	Read Chapter 6 in the <i>User's Guide</i> . These are called <i>class</i> options. You <i>must</i> be superuser to do this. To delete a file, type <code>rm filename</code> .

* The settings on your browser might differ from these settings.

Related Documentation

Title	Part Number
<i>Sun StorEdge 3120 SCSI Array Release Notes</i>	816-7955
<i>Sun StorEdge 3000 Family Software Installation Guide</i>	817-3764
<i>Sun StorEdge 3000 Family Configuration Service 1.5 User's Guide</i>	817-3337
<i>Sun StorEdge 3000 Family Diagnostic Reporter 1.5 User's Guide</i>	817-3338
<i>Sun StorEdge 3000 Family CLI 1.6 User's Guide</i>	817-4951
<i>Sun StorEdge 3000 Family Rack Installation Guide for 1U Arrays</i>	816-7964
<i>Sun StorEdge 3000 Family Safety, Regulatory, and Compliance Manual</i>	816-7930

Accessing Sun Documentation

All Sun StorEdge 3120 SCSI array documentation is available online in both PDF and HTML format at the following location:

http://www.sun.com/products-n-solutions/hardware/docs/Network_Storage_Solutions/Workgroup/3120

or

<http://docs.sun.com/db/coll/3120SCSIarray>

You can view, print, or purchase a broad selection of Sun documentation at:

<http://www.sun.com/documentation>

Contacting Sun Technical Support

For late-breaking news and troubleshooting tips, review the *Sun StorEdge 3120 SCSI Array Release Notes* located at:

http://www.sun.com/products-n-solutions/hardware/docs/Network_Storage_Solutions/Workgroup/3120

If you have technical questions about this product that are not answered in the documentation, go to:

<http://www.sun.com/service/contacting>

To initiate or check on a USA-only service request, contact Sun support at:

800-USA-4SUN

To obtain international technical support, contact the sales office of each country at:

<http://www.sun.com/service/contacting/sales.html>

508 Accessibility Features

The Sun StorEdge documentation is available in 508-compliant HTML files that can be used with assistive technology programs for visually impaired personnel. These files are provided on the Documentation CD for your product as well as on the websites identified in the previous “Accessing Sun Documentation” section. Additionally, the software and firmware applications provide keyboard navigation and shortcuts, which are documented in the user's guides.

Sun Welcomes Your Comments

Sun is interested in improving its documentation and welcomes your comments and suggestions. You can submit your comments by going to:

<http://www.sun.com/hwdocs/feedback>

Please include the title and part number of your document with your feedback:

Sun StorEdge 3000 Family Installation, Operation, and Service Manual, part number 816-7956-11

Array Overview

This chapter provides an overview of your Sun StorEdge 3120 SCSI array, which is an LVD/SE device. Topics covered in this chapter are:

- [“Introducing the Array Model” on page 1-1](#)
- [“Best Practices for the Sun StorEdge 3120 SCSI Array” on page 1-2](#)
- [“Additional Software Tools” on page 1-8](#)

1.1 Introducing the Array Model

The Sun StorEdge 3120 SCSI array model is a JBOD (an array with disks and no controller). Providing up to 584-Gbyte RAID based on 146-Gbyte drives in a 1.75-inch tall by 19-inch wide storage unit, the Sun StorEdge 3120 SCSI array is a high-performance, storage device that contains up to four disk drives with SCSI connectivity to the data host.



FIGURE 1-1 Front View of a Sun StorEdge 3120 SCSI Array

The JBOD (Just a Bunch of Disks) array connects directly to a host server.

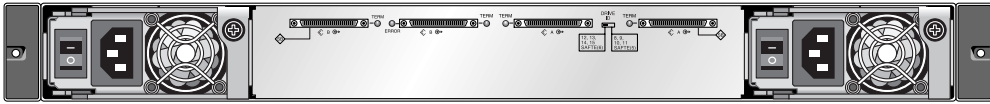

FIGURE 1-2 Rear View of a JBOD

Extensive reliability, availability, and serviceability (RAS) features include redundant components, notification of failed components, and the ability to replace components while the array is online.

The JBOD can be rackmounted in a server cabinet or expansion cabinet.

For information about specifications and agency approvals, see [“SCSI Array Specifications” on page A-1](#).

This document highlights SCSI best practices, which apply to the Sun StorEdge 3120 SCSI array.

1.2 Best Practices for the Sun StorEdge 3120 SCSI Array

The following sections outline small and large storage solutions for common entry-level server environments:

- Print
- File
- Application

These solutions can optimally use the Sun StorEdge 3120 SCSI array, a next-generation Ultra3 SCSI storage system designed to provide direct attached storage (DAS) to entry-level servers.

These solutions feature many performance features using familiar SCSI technology.

Entry-level servers are used for wide range of applications with distinct storage requirements, so the Sun StorEdge 3120 SCSI array features a modular architecture with flexible configurations. Modularity and flexibility enable the storage solution to quickly and easily adapt to a particular environment.

1.2.1 Entry-level Server Storage Requirements

Print, file, and application services are essential network requirements and are among the most popular uses of entry-level servers. The servers used to provide these functions are generally very inexpensive, highly compact units that are often installed in racks for convenience.

One example of such a server is the Sun Fire V120, an expandable single-processor server that occupies just 1 unit (1U) of rack space. Network servers are often distributed throughout an enterprise, making the Sun StorEdge 3120 SCSI array ideally suited for these applications due to its cost-effective direct attached storage design.

TABLE 1-1 Storage Requirements for Single Processor Servers

	Print Server	File Server	Application Server
Availability	Medium	Medium to high	Medium to high
Storage capacity	Low	Low to high	Low to medium
Special needs	High data rates and low cost	High data and transaction rates	Low cost and high transaction rates
Access pattern	Sequential	Sequential	Random

1.2.2 Print Server Architecture and Configuration

The following section outlines small and large storage solutions for print server environments. [FIGURE 1-3](#) shows the scalability between the print server and the Sun StorEdge 3120 SCSI array.

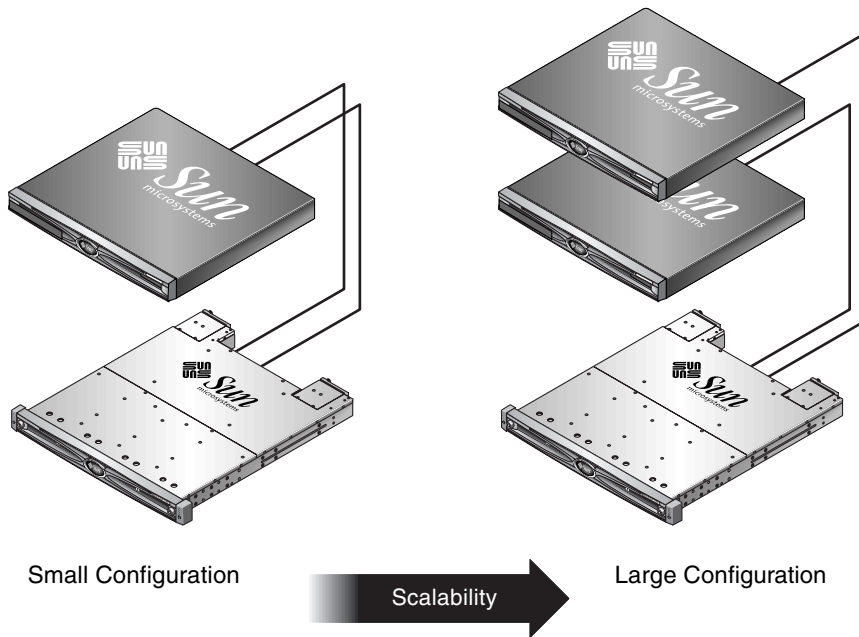

FIGURE 1-3 Optimized Architecture for Print Servers

[TABLE 1-2](#) describes the possible print server configurations.

TABLE 1-2 Configuration Details for Print Servers

	Small Configuration	Large Configuration
JBOD Enclosures	1	1
Number of Disks	2	4
Bus Configuration	Split-bus	Split-bus
RAID Levels Used	Host-based RAID 1	Host-based RAID 1
Drive Configuration	1 LUN	2 LUNs

1.2.2.1 Tips and Techniques

Consider the following tips and techniques when configuring print servers.

- Using a server's built-in SCSI port (if compatible) to minimize cost will result in satisfactory print server performance in most environments, even if the SCSI port does not operate at full Ultra320 speeds.
- Data protection should be provided by host-based software volume management software using the operating system's volume manager or a third-party volume manager. The recommended configurations provide RAS similar to a single controller RAID array.
- Each server must be connected to a different SCSI bus when using the large recommended configuration.

1.2.3 File Server Architecture and Configuration

The following section outlines small and large storage solutions for file server environments. [FIGURE 1-4](#) shows the scalability between the file server and the Sun StorEdge 3120 SCSI array.

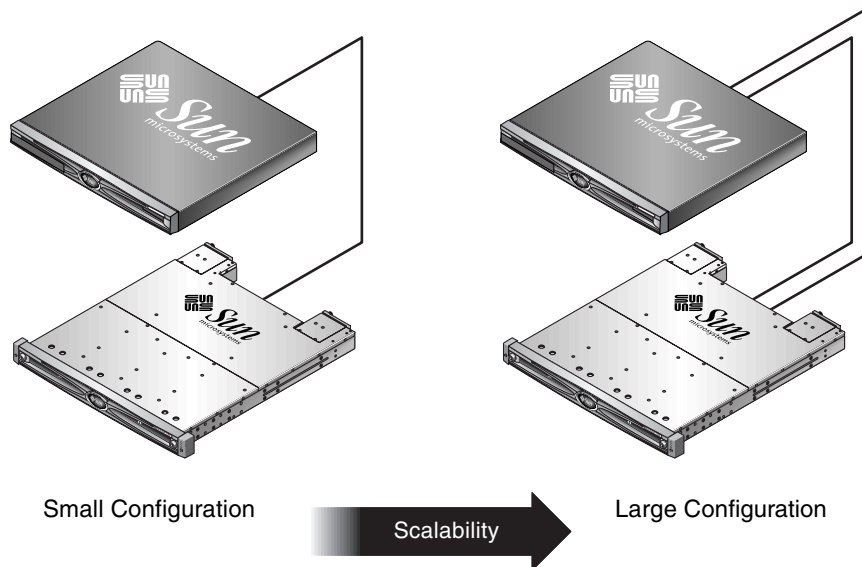

FIGURE 1-4 Optimized Architecture for File Servers

TABLE 1-3 describes the possible file server configurations.

TABLE 1-3 Configuration Details for File Servers

	Small Configuration	Large Configuration
JBOD Enclosures	1	1
Number of Disks	2	4
Bus Configuration	Single-bus	Split-bus
RAID Levels Used	Host-based RAID 1	Host-based RAID 1
Drive Configuration	1 LUN	2 LUNs

Consider the following tips and techniques when configuring file servers.

- You can use an Ultra3 SCSI port to connect the RAID array whenever the server is connected to a LAN using Gigabit Ethernet. Otherwise, a slower SCSI connection may create a performance bottleneck on the SCSI connection.
- If the server has room for only one host adapter and you must choose between Ultra320 SCSI or Gigabit Ethernet adapters, install the Gigabit Ethernet host adapter and use the server's built-in SCSI port to provide the most benefit to users. However, this reduces the I/O to a slower SCSI speed.
- Rapidly growing network response times as users are added is an indication the file server is limiting performance. If this occurs, examine the utilization of server memory, processors, and network adapters and expand those with the highest usage.

1.2.4 Application Server Architecture and Configuration

The following section outlines small and large storage solutions for application server environments. FIGURE 1-5 shows the scalability between the application server and the Sun StorEdge 3120 SCSI array.

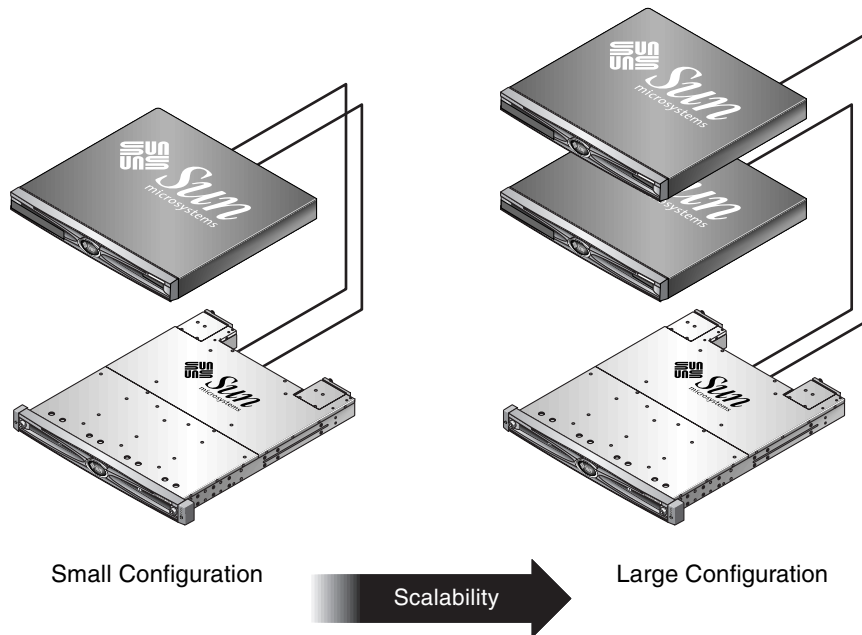

FIGURE 1-5 Optimized Architecture for Application Servers

[TABLE 1-4](#) describes the possible application server configurations.

TABLE 1-4 Configuration Details for Application Servers

	Small Configuration	Large Configuration
JBOD Enclosures	1	1
Number of Disks	2	4
Bus Configuration	Split-bus	Split-bus
RAID Levels Used	Host-based RAID 1	Host-based RAID 1
Drive Configuration	1 LUN	2 LUNs

Consider the following tips and techniques when configuring application servers.

- A single array providing storage for two servers reduces storage costs with little to no effect on application performance.
- Use the built-in SCSI ports of application servers to further minimize costs rather than adding a host adapter, particularly when not using Gigabit Ethernet to the LAN.

- Enhance application server availability by booting them from the RAID array rather than their internal drives. This also facilitates the rapid replacement of malfunctioning or failed servers.

1.3 Additional Software Tools

Additional software tools are available on the Sun Download Center located at:

<http://www.sun.com/software/download/>

The following software tools are available:

- Sun StorEdge Configuration Service, a management and monitoring program
- Sun StorEdge Diagnostic Reporter software, a monitoring utility
- Sun StorEdge CLI, a command-line utility to manage the array

For details on using the software management tools with the SCSI array, see “Software Management Tools” on page 5-1.

For other supported software tools, refer to the release notes for your array, located at:

http://www.sun.com/products-n-solutions/hardware/docs/Network_Storage_Solutions/Workgroup/3120

Site Planning

This chapter outlines the site-planning requirements and basic safety requirements for the installation and use of Sun StorEdge 3120 SCSI arrays. Customers are asked to complete a preinstallation worksheet and to prepare the site for installation according to the worksheet details and the specified site planning requirements.

Review the details of this chapter before installing a Sun StorEdge 3120 SCSI array. Topics covered in this chapter are:

- “Customer Obligations” on page 2-2
- “Safety Precautions” on page 2-2
- “Environmental Requirements” on page 2-3
- “Electromagnetic Compatibility (EMC)” on page 2-4
- “Electrical and Power Specifications” on page 2-4
- “Physical Specifications” on page 2-5
- “Layout Map” on page 2-5
- “Rack Placement” on page 2-6
- “Preinstallation Worksheet” on page 2-6

Note – Refer to the *Sun StorEdge 3120 SCSI Array Release Notes* for the current lists of supported operating environments, host platforms, software, and qualified cabinets.

2.1 Customer Obligations

The customer is obliged to inform Sun Microsystems of any and all ordinances and regulations that would affect installation.



Caution – When selecting an installation site for the Sun StorEdge 3120 SCSI array, choose a location that avoids excessive heat, direct sunlight, dust, or chemical exposure. Such exposure greatly reduces the product’s longevity and might void your warranty.

The customer is responsible for meeting all government codes and regulations concerning facilities. The customer is also responsible for compliance with the following requirements:

- Meet all local, national, and international codes covered in this specification. The subjects covered include fire and safety, building, and electrical codes.
- Document and inform Sun Microsystems of any deviations from this specification.

2.2 Safety Precautions

For your protection, observe the following safety precautions when setting up your equipment:

- Follow all safety precautions and requirements specified in the *Sun StorEdge 3000 Family Safety, Regulatory, and Compliance Manual*.
- A fully loaded array weighs over 30 pounds (13.608 kg). Use two people to lift the array to avoid injury.
- Follow all cautions and instructions marked on the equipment.
- Ensure that the voltage and frequency of your power source match the voltage and frequency inscribed on the equipment’s electrical rating label.
- Never push objects of any kind through openings in the equipment. Dangerous voltages might be present. Conductive foreign objects could produce a short circuit that could cause fire, electric shock, or damage to your equipment.

- To reduce the risk of electric shock, do not plug Sun products into any other type of power system. Sun products are designed to work with single-phase power systems having a grounded neutral conductor. Contact your facilities manager or a qualified electrician if you are not sure what type of power is supplied to your building.
- Your Sun product is shipped with a grounding-type (three-wire) power cord. To reduce the risk of electric shock, always plug the cord into a grounded power outlet.
- Do not use household extension cords with your Sun product. Not all power cords have the same current ratings. Household extension cords do not have overload protection and are not meant for use with computer systems.
- Do not block or cover the openings of your Sun product. Never place a Sun product near a radiator or heat register. Failure to follow these guidelines can cause overheating and affect the reliability of your Sun product.

2.3 Environmental Requirements

TABLE 2-1 Environmental Specifications

	Operating	Non-Operating
Altitude	To 3000 meters (9000 feet)	To 12,000 meters (36,000 feet)
Temperature	5 degrees C to 35 degrees C	-40 degrees C to +65 degrees C
Humidity Range	10% to 90% @ 40 degrees C (noncondensing)	0 to 93% @ 38 degrees C (noncondensing)

2.4 Electromagnetic Compatibility (EMC)

The following is required for all installations:

- All AC mains and supply conductors to power distribution boxes for the rackmounted array must be enclosed in a metal conduit or raceway when specified by local, national, and other applicable government codes and regulations.
- The supply conductors and power distribution boxes (or equivalent metal enclosure) must be grounded at both ends.
- The supplied arrays require voltages within minimum fluctuation.
- The facilities voltage supplied by the customer must maintain a voltage of not more than (+/-) 5 percent. The customer facilities must provide suitable surge protection.

2.5 Electrical and Power Specifications

All Sun StorEdge 3120 SCSI arrays require two independent power sources. Each array has two power-supply-and-fan modules for redundancy.

Each Sun StorEdge 3120 AC array requires two 115 VAC/15A or two 240 VAC service outlets. All AC power supplies are autoranging and are automatically configured to a range of 90-264 VAC and 47-63 Hz. There is no need to make special adjustments.

Each DC array requires two -48 VDC service outlets, and has an input voltage range of -36 VDC to -72 VDC.

Note – To ensure power redundancy, connect the two Sun StorEdge 3120 SCSI power modules to two separate circuits (for example, one commercial circuit and one UPS).

TABLE 2-2 Power Specifications

AC power:	Voltage and frequency 90 to 264 VAC, 47 to 63 Hz
Input current:	4A max
Power-supply output voltages:	+5 VDC and +12 VDC
DC power:	-48 VDC (-36 VDC to -72 VDC)

2.6 Physical Specifications

Use the following physical specifications to plan the location of your array.

TABLE 2-3 Physical Specifications

Category	Description
Dimensions	1U (1.75-inch / 4.445 cm.) height 20-inch / 50.8 cm. chassis depth 17.5-inch / 44.45 cm. (19-inch / 48.26 cm. with ears) width
Installation clearances	For FRU removal and replacement, 15-inch (37 cm.) is required for front and back.
Cooling clearances	6-inch (15 cm.) is required front and back. No cooling clearance is required on the sides or the top and bottom of the array.

2.7 Layout Map

It is helpful to create a sketch or layout map to indicate the exact location for the Sun StorEdge 3120 SCSI array installation as well as the location of the hosts.

As you lay out the components, consider the cable lengths. For more information about cables, see [“Bus and Cable Lengths” on page 4-7](#).

2.8 Rack Placement

Follow these guidelines when preparing a rackmount placement for your system.

- Ensure that the floor surface is level.
- Leave enough space in front of the rack to access components for servicing.
- Leave enough space in back of the rack to access components for servicing.
- Keep power and interface cables clear of foot traffic. Route cables inside walls, under the floor, through the ceiling, or in protective channels or raceways.
- Route interface cables (excluding fiber-optic cables) away from motors and other sources of magnetic or radio frequency interference.
- Stay within the cable length limitations.
- Provide two separate power sources for the array. These power sources must be independent of each other, and each must be controlled by a separate circuit breaker at the power distribution point.

2.9 Preinstallation Worksheet

When ordering a Sun StorEdge 3120 SCSI array, complete the following Preinstallation Worksheet and then prepare the site for installation according to the site-planning requirements.

You are responsible for ensuring that the site consistently conforms to all stipulated standards, and that necessary peripherals are made available to the engineer during installation.

Review the details of your specific survey before installing your Sun StorEdge 3120 SCSI array.

If necessary, attach or sketch a network diagram to the survey.

TABLE 2-4 Preinstallation Worksheet

Rackmounting	<p>Customers must ensure that the appropriate service outlets are available for installation. Requirements vary.</p> <p>Will the Sun StorEdge 3120 SCSI array be rackmounted? Yes / No</p> <ul style="list-style-type: none">• Is the rack supplied by Sun? Yes / No• If yes, include Sun model number: _____• If not, make/model: _____ / _____ <p>Does the rack mount:</p> <ul style="list-style-type: none">• Front and back? If so, depth? _____• Center/Telco? _____ <p>What cable lengths are required? _____</p> <p>** Diagram preferred **</p> <p>Are there any power strips or power sequencers in the rack? Yes / No</p> <p>Are they supplied by Sun? Yes / No If yes, part number: _____</p> <p>If not, quantity of plugs/outlets required: _____ / _____</p>
IP address	<p>Array IP address: _____.</p> <p>Array network mask: _____.</p>
Cabling	<p>SCSI cable lengths to connect to hosts: _____</p>

TABLE 2-5 Host Connectivity Summarized

Host Connectivity - Host #1

Host Name: _____

Host Make/Model: _____

HBA connector types: _____

Cable distance from the array to the host(s): _____

Operating system: _____

Patches installed: _____

IP addresses:

- Network _____
 - Host _____
-

Host Connectivity - Host #2

Host Name: _____

Host Make/Model: _____

HBA connector types: _____

Cable distance from the array to the host(s): _____

Operating system: _____

Patches installed: _____

IP addresses:

- Network _____
 - Host _____
-

Inspecting the Array Package

This chapter provides the general procedure for inspection and reviews the Sun StorEdge 3120 SCSI array package. Topics covered in this chapter include:

- [“Unpacking the Array” on page 3-1](#)
- [“Checking the Package Contents” on page 3-2](#)
- [“Field-Replaceable Units” on page 3-3](#)
- [“Customer-Provided Cables” on page 3-3](#)

3.1 Unpacking the Array

Follow these guidelines for unpacking the equipment.



Caution – Always use two people to remove the unit from its container, to avoid personal injury or damage to the equipment during installation. A fully loaded unit weighs approximately 30 pounds (13.608 kg).

1. **Select a suitable area for unpacking.**
2. **Store all packing material and boxes for possible equipment returns.**
3. **Check the Contents Sheet in your product package.**
The Contents Sheet summarizes the standard contents for your product. See [“Checking the Package Contents” on page 3-2](#).
4. **Compare the packing slip and the list of parts with the items you received.**
If the list of parts on your packing slip does not match the items you received, or any items appear damaged, immediately notify your carrier agent and the supplier who prepared your shipment.

5. Carefully examine the cables provided in the package.

If any cable appears to be damaged, contact the Technical Service department for an immediate replacement.

6. Check the list of “Customer-Provided Cables” on page 3-3.

These are required to complete your installation.



Caution – You must purchase or provide 320M-compliant SCSI cables for connecting the Sun StorEdge 3120 SCSI array to host servers.

3.2 Checking the Package Contents

It is important to inspect your Sun StorEdge 3120 SCSI array packages for standard items as well as purchased options before you begin installation. If any parts are missing or damaged, contact your sales representative immediately.

Quantity	Item
1	Sun StorEdge 3120 SCSI array (a group of disks, no controller)
1	<i>Sun StorEdge 3120 SCSI Array Contents Sheet</i> <ul style="list-style-type: none">To download and print the latest <i>Sun StorEdge 3120 SCSI Array Release Notes</i>, go to: http://www.sun.com/products-n-solutions/hardware/docs/Network_Storage_Solutions/Workgroup/3120
1	SCSI jumper cable, 1 foot (30 cm.), VHDCI-VHDCI (for bus setting)
2	DC power cables if you ordered a DC-powered array
2	AC cord locks in a plastic bag if you ordered an AC-powered array
2	Front-bezel keys in a plastic bag, to secure the front bezel onto the chassis
Various	Purchased options. These options are ordered at the time of purchase and are integrated into or added to the unit prior to delivery.

3.3 Field-Replaceable Units

Check that you received all field-replaceable units (FRUs) ordered with your Sun StorEdge 3120 SCSI array. For a complete list of FRUS, see [“Available FRUs” on page 8-1](#).

3.4 Customer-Provided Cables

Customers must provide the following cables.

- Two 3-prong AC power cables if you have an AC-powered array.
- One Ultra 320 SCSI cable per host to connect a host to an array; up to two host cables may be needed per array.

To obtain qualified cables, consult your Sun sales representative.

Connecting Your SCSI Array

This chapter provides procedures for cabling the Sun StorEdge 3120 SCSI array for single-bus or split-bus configurations and for connecting the array to power and to network devices.

The topics covered in this chapter are as follows:

- [“Converting Your Front Bezel Locks So the Keys Cannot Be Removed”](#) on page 4-2
- [“Rackmounting the Array”](#) on page 4-4
- [“Connecting Chassis to an AC Power Outlet”](#) on page 4-4
- [“Connecting the Chassis to DC Power Outlets”](#) on page 4-6
- [“Bus and Cable Lengths”](#) on page 4-7
- [“Connecting Sun StorEdge 3120 SCSI Arrays to Hosts”](#) on page 4-8
 - [“Single-Bus \(SB\) Label”](#) on page 4-9
 - [“Fixed Drive IDs”](#) on page 4-10
 - [“Connecting Cables for a Single-Bus Configuration”](#) on page 4-11
 - [“A Single-Bus JBOD with One Host Connection”](#) on page 4-12
 - [“A Single-Bus, Multi-Initiator JBOD Configuration”](#) on page 4-14
 - [“A Split-Bus, Single-Initiator JBOD Configuration”](#) on page 4-15
 - [“A Split-Bus, Multi-Initiator JBOD Configuration Connected to One JBOD”](#) on page 4-18

Before you connect the Sun StorEdge 3120 SCSI array to the network, position the Sun StorEdge 3120 SCSI array in the rack or in the location where it will remain.



Caution – When positioning the array, do not block the air vents at the front or back of the unit. Follow all safety precautions specified in the *Sun StorEdge 3000 Family Safety, Regulatory, and Compliance Manual*.



Caution – When you power off the array, wait five seconds before you power it back on. If you power the array off and on too quickly, a race condition might occur.

4.1 Converting Your Front Bezel Locks So the Keys Cannot Be Removed

The bezel on your array has two locks whose keys can be removed when the locks are in either the locked or open position. It is possible to reconfigure the locks so that the keys cannot be removed.



FIGURE 4-1 Front Bezel and Front Bezel Locks of an Array

To change the locks so the keys cannot be removed, follow these steps:

1. **Remove the bezel by gently pivoting the swing arms out of their ear sockets, and make sure the key is in the locked position, with the pawl extending horizontally past the edge of the bezel (see the first panel of [FIGURE 4-2](#)).**
2. **Hold the key in place and use a 12 mm or 3/8-inch nut driver to remove the locking nut that holds the pawl in place as shown in the first panel of [FIGURE 4-2](#).**



Caution – Be sure to hold the key in place. Otherwise there is a risk of breaking the small tab on the lock that serves as a stop.

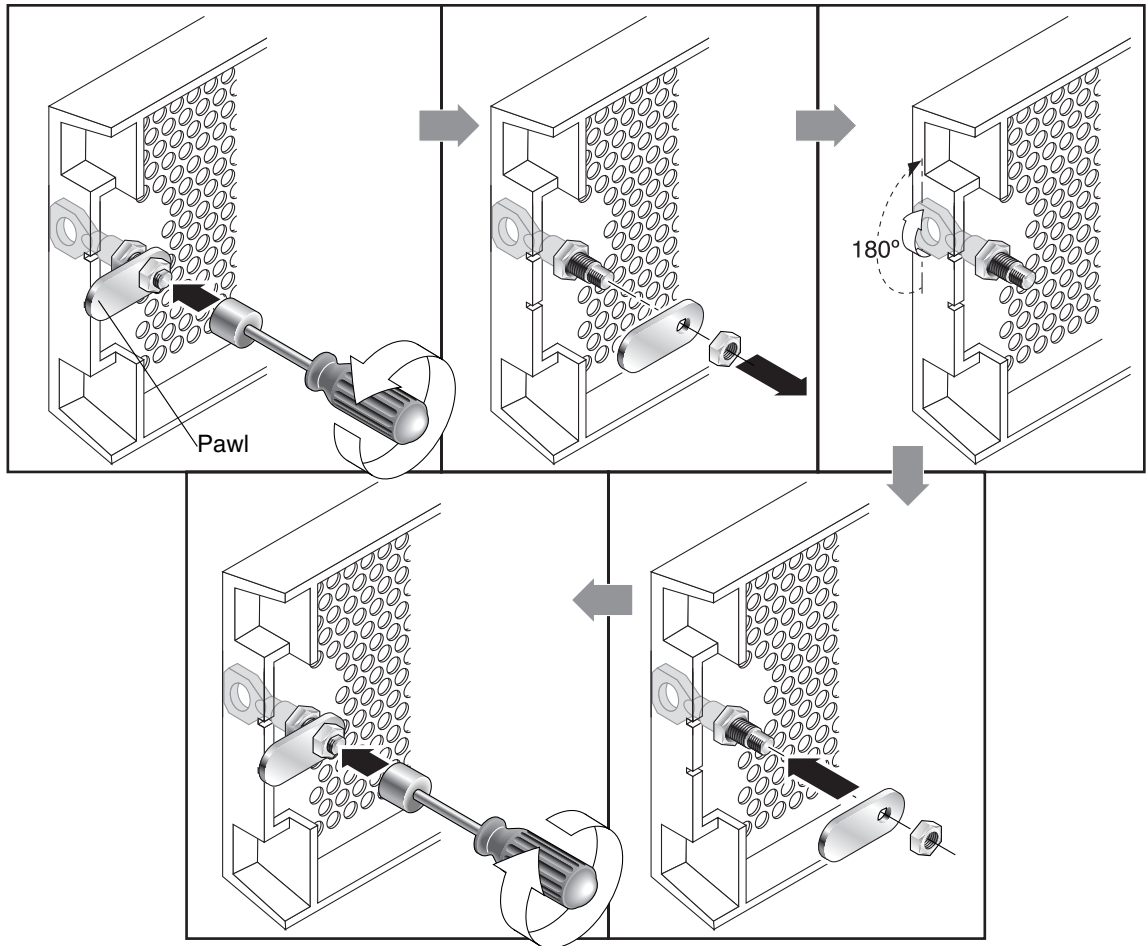

FIGURE 4-2 Sequence of Steps to Change Front Bezel Locks So Keys Cannot Be Removed

3. Lift the pawl off the threaded part of the lock body, as shown in the second panel of [FIGURE 4-2](#).
4. Set the pawl aside, face up, so that you can remember its orientation when you replace it.
5. Use the key to turn the lock 180 degrees, as shown in the third panel of [FIGURE 4-2](#).
6. Replace the pawl in the same orientation as before, as shown in the fourth panel of [FIGURE 4-2](#).
7. Hold the key in place and use the nut driver to refasten the locking nut that holds the pawl in place, as shown in the fifth panel of [FIGURE 4-2](#). Be careful not to cross-thread the nut.



Caution – Be sure to hold the key in place. Otherwise there is a risk of breaking the small tab on the lock that serves as a stop.

8. **Replace the bezel.**

Note – To convert your bezel locks back so that the keys can be removed, repeat the preceding steps.

4.2 Rackmounting the Array

To rackmount the array in a rack or a cabinet, refer to the installation manual which is provided with the rack or refer to the *Sun StorEdge 3000 Family Rack Installation Guide for 1U Arrays* on the product website.

4.3 Connecting Chassis to an AC Power Outlet

When you connect the AC power cords, you should install the provided two cord locks at the same time. To connect the AC power cords, perform the following procedure.

1. **Connect an appropriate AC power cable to the first power supply and to a power outlet.**

The provided AC cord locks are used to securely fasten the AC cable connectors.



Caution – For AC power: If the array is connected to AC power sources not within the designated 90–264 VAC range, damage might occur to the unit.

Note – To ensure power redundancy, be sure to connect the two power supply modules to two separate circuits (for example, one commercial circuit and one UPS).

2. **Use a screwdriver to remove the screw from one of the two cord locks provided.**

3. Turn the thumbscrew of the green ejector handle counterclockwise to release the handle.
4. Pull the green ejector handle of the first power supply forward, and slide the cord lock around the handle and around the AC power connector on the power supply. The cord lock fits very snugly around the power cable connector.
5. Slide the cord lock screw through the cord lock holes, and tighten the screw with a screwdriver.
Close the green ejector handle, and turn the thumbscrew clockwise to close the handle.
6. Repeat steps 2 through 5 for the second cord lock and second power cable.

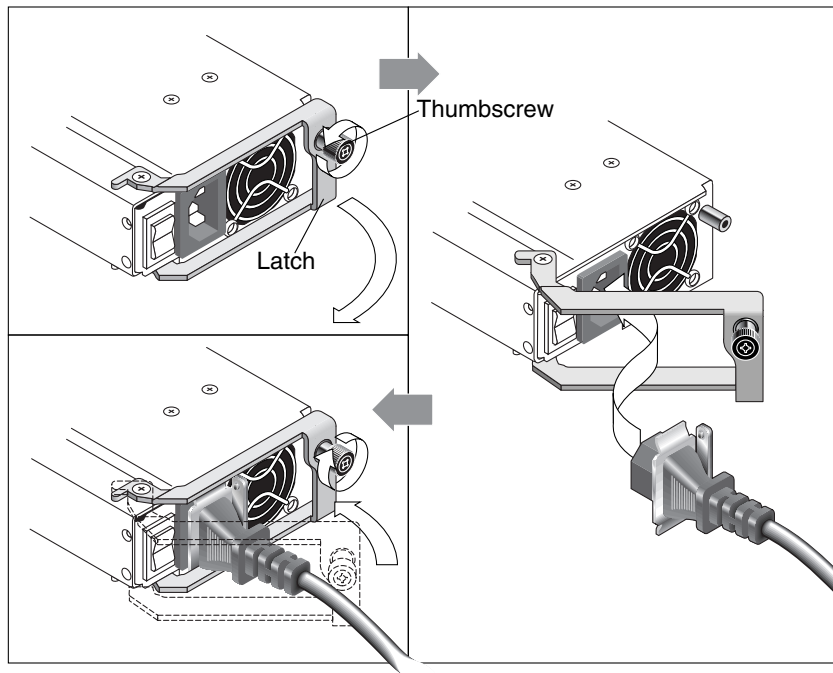

FIGURE 4-3 Cord Lock Operation

4.4 Connecting the Chassis to DC Power Outlets

Two DC power cords are packaged with each DC array. To connect the DC power cords, perform the following procedure.

1. Connect a DC power cable to the first power supply and to a power outlet.

Note – Use only the DC power cables provided with the array.

2. Check the DC cable part number and wire labels carefully before connecting the cable to the source.

TABLE 4-1 DC Cable Wiring for Cable 35-00000148

Pin Number	Voltage	Color
A3	Return	Red
A2	GND (Chassis Ground)	Green/Yellow
A1	-48vdc	Black

TABLE 4-2 DC Cable Wiring for Cable 35-00000156

Pin Number	Voltage	Color
A3	L+	Red
A2	GND (Chassis Ground)	Green/Yellow
A1	L-	White



Caution – If the Sun StorEdge 3120 SCSI array is connected to DC power sources not within the designated –48V DC (–36 VDC to –72 VDC) range, damage might occur to the unit.

Note – To ensure power redundancy, be sure to connect the two power supply modules to two separate circuits (for example, one commercial circuit and one UPS).

Note – To extend the length of the DC power cable as needed, strip the last 1/4 inch of the cable, insert the stripped end into a provided Panduit tube, and crimp the tube.

3. **Tighten the cable locking screws to attach the cable securely to the power supply power outlet.**
4. **Connect the second power cable to the second power supply and to a second power outlet. Tighten the cable locking screws.**

If one power supply fails, the second power supply automatically takes the full load.

4.5 Bus and Cable Lengths

The SCSI specification states that the maximum bus length for Ultra320 SCSI is 12 meters for multidrop connections. The Sun StorEdge 3120 SCSI array uses a multidrop implementation. The ports on each channel are connected to the same physical SCSI bus.

Taking into account the internal bus length of .7 meters, and the internal SCSI bus length of the host, the maximum SCSI bus length for each channel is 12 meters when connected to an LVD host adapter.

You must ensure that the length of all cables to any connected nodes, as well as the internal bus length of .7 meters internal to the Sun StorEdge 3120 SCSI array and the internal bus length of the host, is less than 12 meters in total. Also include the jumper cable length of .3 meters if the JBOD is being used in a single-bus or multi-initiator configuration. In a dual-host, multi-initiator configuration, each host cable should be 5 meters or less.

The longest Ultra320 cable qualified by Sun is 10 meters in length.

When connected to single-ended host adapters, the longest supported bus length per channel is 1.5 meters.

Note – If you connect two hosts to the same channel, you must change the scsi-initiator-id of one host adapter as described in the host adapter documentation. When either of these hosts is subsequently booted, SCSI reset warnings are displayed on the other host.

4.6 Connecting Sun StorEdge 3120 SCSI Arrays to Hosts

You can connect a JBOD (Just a Bunch of Disks, no controller) array directly to a Sun host server using either single-bus or split-bus configurations. With the Sun StorEdge 3120 SCSI array, you can configure the following:

- [“A Single-Bus JBOD with One Host Connection” on page 4-12](#)
- [“A Single-Bus, Multi-Initiator JBOD Configuration” on page 4-14](#)
- [“A Split-Bus, Single-Initiator JBOD Configuration” on page 4-15](#)
- [“A Split-Bus, Multi-Initiator JBOD Configuration Connected to One JBOD” on page 4-18](#)

The array can be connected to a host by means of a 320 MB/second PCI Dual Ultra320 SCSI host adapter installed in a host.

Connect the array to one or two hosts with SCSI cables. The TERM LED is a solid green color when a drive is available for configuration. For details on the TERM LED, see [“Back-Panel LEDs” on page 6-4](#).

Note – If you use multiple host servers, they must use the same operating system. The host server operating system release or version number can differ. For instance, host server A can run Solaris 8 while host server B runs Solaris 9.



Caution – SCSI IDs are set based on the switch setting on the array when it is powered on. If you change the switch setting, the SCSI IDs will change after you power off, and then power on. For more details on switch settings, see [“Fixed Drive IDs” on page 4-10](#).



Caution – The I/O module is hot-serviceable which means that you can connect or disconnect its cables while the array is powered on but the SCSI host buses connected to the array must be inactive.

4.6.1 Single-Bus (SB) Label

The drive-bus configuration determines how drives and drive IDs are assigned to drive channels.

On the rear panel of each unit, the SB icon indicates where to connect the SCSI jumper cable for a single-bus configuration. The SB icons are located next to the SCSI ports on the far right and on the far left.

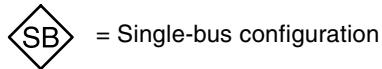

FIGURE 4-4 Single-Bus Icon

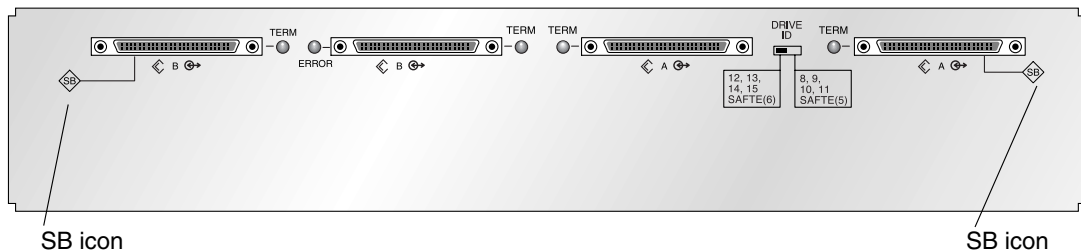

FIGURE 4-5 Single-Bus Icon as it appears on the rear of the JBOD

Since no SCSI jumper cable is required for a split-bus configuration, there is no indicator icon.

Note – If a jumper cable is not attached to the JBOD, it is automatically a split-bus configuration.

The SCSI IDs are also displayed on the lower inside-front edge of the chassis in front of each drive. These IDs are automatically assigned based on the switch setting. For more information on switch settings and drive IDs, see the following section, [“Fixed Drive IDs” on page 4-10](#).

4.6.2 Fixed Drive IDs

Drive IDs are not dependent on the configuration type. Single-bus and split-bus configurations use the same drive IDs. The IDs assigned for disks 1 through 4 depend on the switch settings on the JBOD array. IDs 5 and 6 are reserved for SAF-TE IDs. The fixed drive IDs for a 4-drive configuration are shown in [FIGURE 4-6](#).

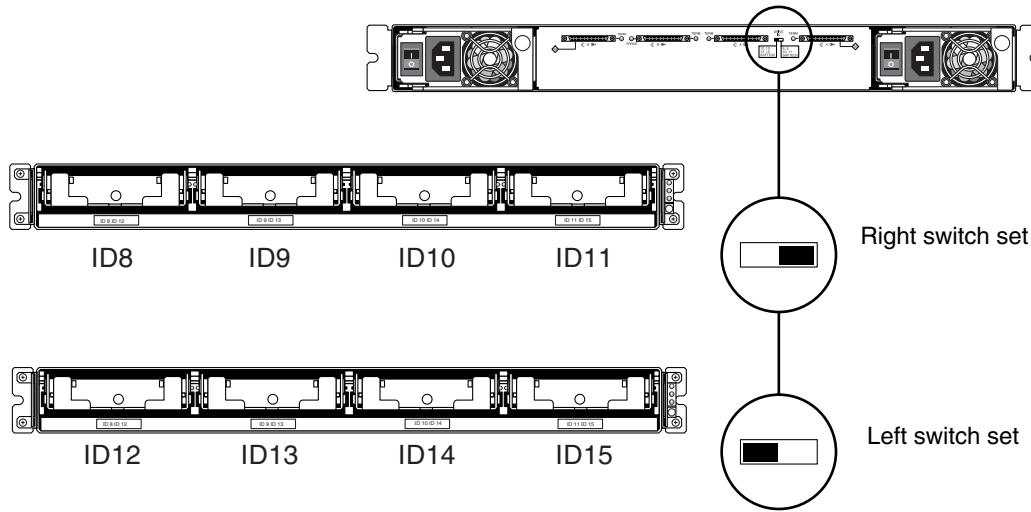

FIGURE 4-6 Drive IDs for Single-Bus and Split-Bus Configurations



Caution – SCSI IDs are set based on the switch setting on the array when it is powered on. If you change the switch setting, the SCSI IDs will change after you power off, and then power on.

The following table shows the drive IDs that correspond with the switches in [FIGURE 4-6](#).

TABLE 4-3 Switch Settings and Drive IDs for Single-Bus and Split-Bus Configurations

	Drive IDs	SAF-TE ID
Right Switch	8, 9, 10, 11	5
Left Switch	12, 13, 14, 15	6

Note – Each device in your SCSI configuration must have a unique ID. For instance, if your HBA device uses ID 6, do not use the left-switch setting, which sets the SAF-TE ID to 6. Use the right-switch setting.

The IDs are also displayed on the lower inside-front edge of the chassis in front of each drive. These IDs are automatically assigned based on the switch setting as shown in [FIGURE 4-6](#).

The following illustration shows the port names. The port names, A and B, are used for easy reference in the cabling procedures. In a single-bus configuration, the B Out and the A In ports are available for host connections. For more information, see [“A Single-Bus JBOD with One Host Connection”](#) on page 4-12 or [“A Single-Bus, Multi-Initiator JBOD Configuration”](#) on page 4-14. In a split-bus configuration, several host connection configurations exist. For details, see [“A Split-Bus, Single-Initiator JBOD Configuration”](#) on page 4-15 or [“A Split-Bus, Multi-Initiator JBOD Configuration Connected to One JBOD”](#) on page 4-18.

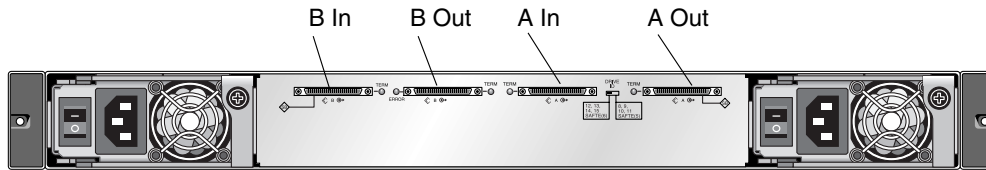

FIGURE 4-7 Sun StorEdge 3120 SCSI Array Port Names

4.6.3 Connecting Cables for a Single-Bus Configuration

A single-bus I/O configuration assigns all disk drive IDs in a chassis to one channel.

1. To configure a JBOD unit as a single-bus configuration, connect the SCSI jumper cable between SCSI ports labeled with the SB icon, the B In and A Out ports as shown in [FIGURE 4-7](#). Tighten the cable jack screws with six full clockwise turns to ensure proper connection and operation.

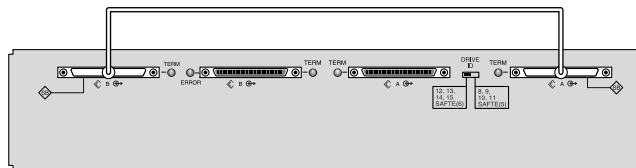

FIGURE 4-8 Cabling for Single-Bus JBOD

2. Connect your JBOD array to a host server with SCSI cables as shown in [FIGURE 4-8](#), [FIGURE 4-9](#), or [FIGURE 4-10](#).



Caution – When you connect the host cable in single-bus configuration, attach the host cable in a way that does not bend or damage the jumper cable.

4.6.4

A Single-Bus JBOD with One Host Connection



Caution – BEFORE you disconnect a cable from the array, the host bus on that cable must be inactive.



Caution – When you connect the host cable in single-bus configuration, attach the host cable in a way that does not bend or damage the jumper cable.

To connect a JBOD in a single-bus configuration to a single host, connect the following ports:

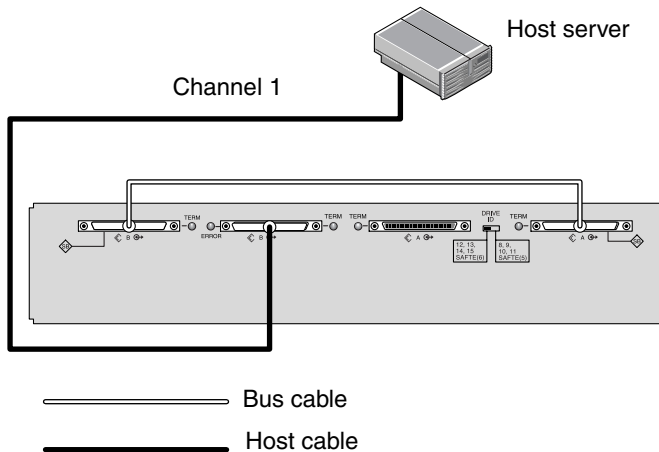

FIGURE 4-9 JBOD Directly Connected to a Host (Single-Bus)

In [FIGURE 4-9](#), the host server is connected to port B Out. The following table shows the drive IDs for [FIGURE 4-9](#).

TABLE 4-4 Example of Drive IDs for a Single Host, Single-Bus, Left-Switch Setting

Channel	Switch	ID
1	Left	12, 13, 14, 15

To connect multiple JBODs in a single-bus configuration to a single host, connect the following ports:

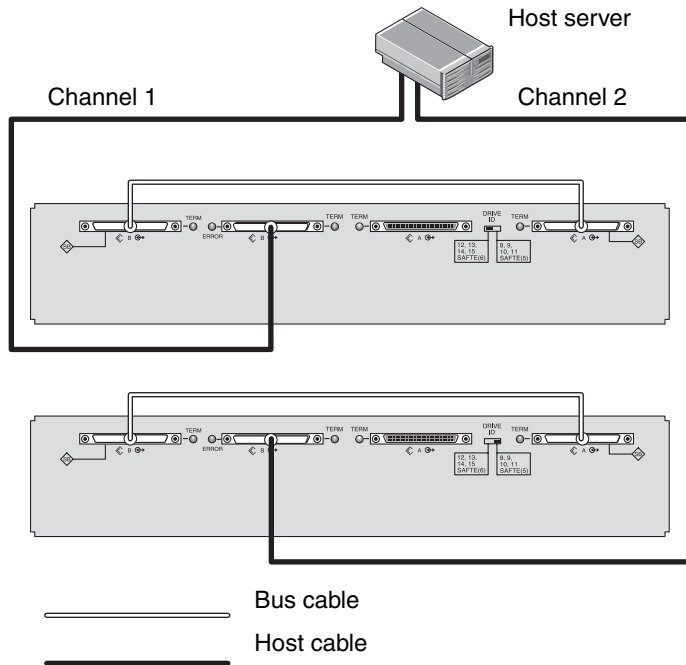

FIGURE 4-10 Multiple JBODs Directly Connected to a Host (Single-Bus)

In [FIGURE 4-10](#), the host server is connected to port B Out. The following table shows the drive IDs for [FIGURE 4-10](#).

TABLE 4-5 Example of Drive IDs for a Single Host, Single-Bus Switch Settings

Channel	Switch	ID
1	Left	12, 13, 14, 15
2	Right	8, 9, 10, 11

4.6.5 A Single-Bus, Multi-Initiator JBOD Configuration

A dual-host, single-bus multi-initiator configuration primarily works in conjunction with multi-initiator software such as Sun Cluster or Veritas Cluster. In this configuration, each host server is connected to each host channel. Without the multi-initiator software, the host servers can write to the same drive simultaneously which may overwrite data.

You can configure a non-cluster dual-host, single-bus environment, but you must ensure that the hosts write to different disks on the SCSI bus by setting up a special configuration. For instance, you can specifically configure which host writes to each disk to prevent data overwrites.

Note – Each device in your configuration must have a unique ID, including any HBA devices. For instance, if your HBA device uses ID 6, do not use the left-switch setting, which sets the SAF-TE ID to 6. For details on setting the HBA device ID, see [“Enabling VERITAS DMP in a Single-Bus Configuration”](#) on page 5-17.



Caution – BEFORE you disconnect a cable from the array, the host bus on that cable must be inactive.



Caution – When you connect the host cable in single-bus configuration, attach the host cable in a way that does not bend or damage the jumper cable.

To connect a JBOD in a single-bus configuration to dual hosts, connect the following ports:

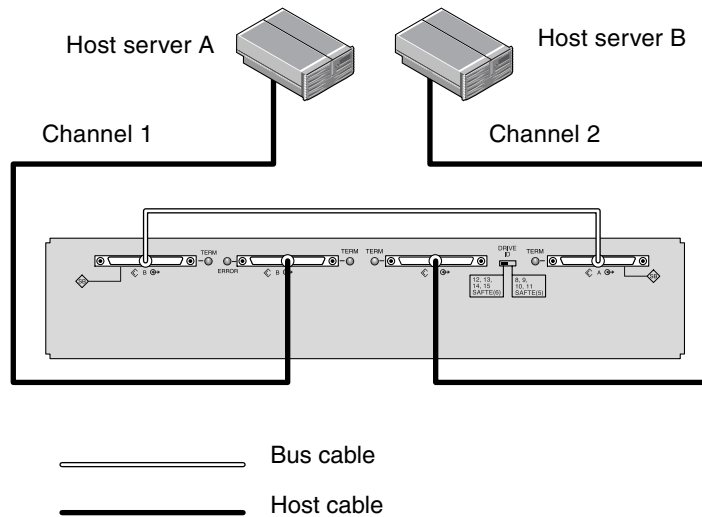

FIGURE 4-11 JBOD Directly Connected to Two Hosts (Single-Bus)

In [FIGURE 4-11](#), Host A is connected to port B Out and Host B is connected to port A In. The following table shows the drive IDs for [FIGURE 4-11](#).

TABLE 4-6 Example of Drive IDs for Dual Hosts, Single-Bus, Right-Switch Setting

Server	Channel	Switch	ID
A	1	Right	8, 9, 10, 11
B	2	Right	8, 9, 10, 11

4.6.6 A Split-Bus, Single-Initiator JBOD Configuration

There are two important features to note with the split-bus, single-initiator mode JBOD configuration:

- Connect one A and one B input port on the JBOD with an HBA host connection to the host. The I/O SCSI connectors are auto-terminated.
- In a split-bus configuration, the SCSI ID numbers automatically change according to the switch settings. For more information on switch settings, see [“Fixed Drive IDs” on page 4-10](#).

Single-initiator mode is when there is only one host connection on a SCSI channel.



Caution – BEFORE you disconnect a cable from the array, the host bus on that cable must be inactive.

FIGURE 4-12 shows a split-bus JBOD with two host connections, one host connection to each channel (single-initiator mode). This is an efficient way to provide mirroring capability for a single host.

Note – You can connect the cables to the inboard or outboard ports on a JBOD. Both configurations work. **FIGURE 4-12** shows the cables connected to the outboard ports.

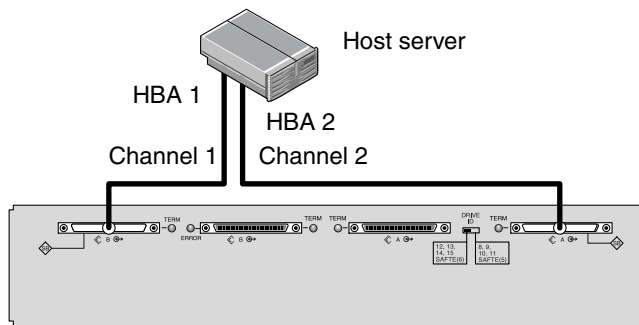

FIGURE 4-12 JBOD Directly Connected to a Host (Split-Bus)

In **FIGURE 4-12**, HBA 1 is connected to port B In and HBA 2 is connected to port A Out. The following table shows the drive IDs for **FIGURE 4-12**.

TABLE 4-7 Example of Drive IDs for a Single Host, Split-Bus, Left-Switch Setting

HBA	Channel	Switch	ID
1	1	Left	14, 15
2	2	Left	12, 13

FIGURE 4-13 shows multiple hosts with multiple JBODs in a split-bus JBOD configuration with two host connections, one host connection to each channel (single-initiator mode). This is an efficient way to provide mirroring capability.

Note – You can connect the cables to the inboard or outboard ports on a JBOD. Both configurations work. **FIGURE 4-13** shows the cables connected to the outboard ports on the upper JBOD and the cables connected to the inboard ports on the lower JBOD.

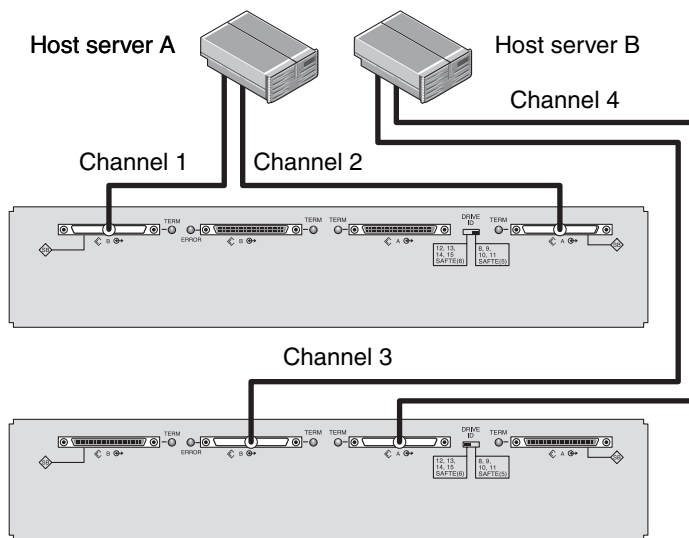

FIGURE 4-13 JBODs Directly Connected to Hosts (Split-Bus)

In [FIGURE 4-13](#), Host A is connected to port B In and port A Out, and Host B is connected to port B Out and port A In. The following table shows the drive IDs for [FIGURE 4-13](#).

TABLE 4-8 Example of Drive IDs for Multiple Hosts, Split-Bus Switch Settings

Server	Switch	Channel	ID
A	Right	1	10, 11
A	Right	2	8, 9
B	Left	3	14, 15
B	Left	4	12, 13

To connect a split-bus JBOD, perform the following steps.

1. Connect each JBOD port to a host as shown in [FIGURE 4-13](#).
2. Make inactive the host bus connections of any cable which will be installed or removed.
3. Use your host system disk management utilities to prepare the disks in the Sun StorEdge 3120 SCSI array for use.

Refer to your host system documentation for more information about disk management utilities available to you.

4.6.7

A Split-Bus, Multi-Initiator JBOD Configuration Connected to One JBOD

A dual-host, split-bus, multi-initiator configuration primarily works in conjunction with multi-initiator software such as Sun Cluster or Veritas Cluster. In this configuration, each host server is connected to two host channels. Without the multi-initiator software, the host servers can write to the same drive simultaneously which may overwrite data.

You can configure a non-cluster dual-host, split-bus, multi-initiator environment, but you must ensure that the hosts write to different disks on the SCSI bus by setting up a special configuration. For instance, you can specifically configure which host writes to each disk to prevent data overwrites.



Caution – BEFORE you disconnect a cable from the array, the host bus on that cable must be inactive.

To connect a JBOD in a split-bus configuration to two hosts, connect the following ports:

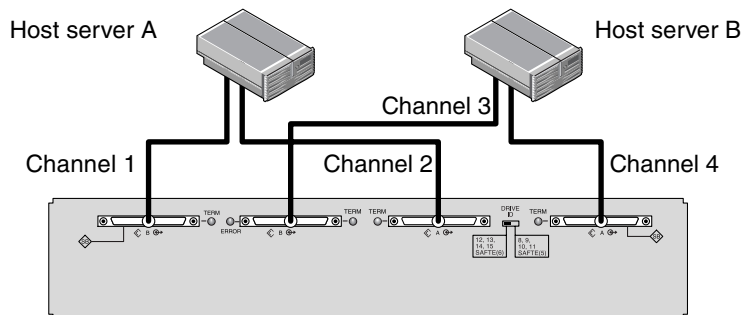

FIGURE 4-14 Dual-Host, Multi-Initiator Array Connected to a Single JBOD

In [FIGURE 4-14](#), Host A is connected to port B In and to port A In. Host B is connected to port B Out and to port A Out. This configuration is common for failover protection in a network cluster environment.

The following table shows the drive IDs for [FIGURE 4-14](#).

TABLE 4-9 Example of Drive IDs for Multiple Hosts in a Dual-Initiator Configuration with a Left-Switch Setting

Server	Switch	Channel	ID
A	Left	1	14, 15
A	Left	2	12, 13
B	Left	3	14, 15
B	Left	4	12, 13

Software Management Tools

This chapter describes the software management tools used for monitoring and managing the Sun StorEdge 3120 SCSI array. Topics include the following:

- [“Overview of Provided Software” on page 5-1](#)
- [“Monitoring with the Sun StorEdge Configuration Service” on page 5-2](#)
- [“Event Messages from the Sun StorEdge Diagnostic Reporter” on page 5-6](#)
- [“Monitoring with the Sun StorEdge CLI” on page 5-7](#)
- [“Managing Disks in the Sun StorEdge 3120 SCSI Array” on page 5-17](#)
- [“Enabling VERITAS DMP in a Single-Bus Configuration” on page 5-17](#)

Note – For other supported software, see the Release Notes for your array.

5.1 Overview of Provided Software

This section describes the software management tools available for monitoring and managing the Sun StorEdge 3120 SCSI array with in-band connections.

The following software management tools are provided on the Sun StorEdge 3000 Family Professional Storage Manager CD, provided with your array. The Sun StorEdge 3000 Family Documentation CD provides the related user guides.

- **Sun StorEdge Configuration Service.** Provides monitoring functions. Refer to the *Sun StorEdge 3000 Family Configuration Service User’s Guide* for in-band setup procedures.
- **Sun StorEdge Diagnostic Reporter.** Provides event monitoring and notification. Refer to the *Sun StorEdge 3000 Family Diagnostic Reporter User’s Guide* for information.

- **Sun StorEdge Command-Line Interface (CLI).** A command-line interface utility that provides script-based management. Refer to the *Sun StorEdge 3000 Family CLI User's Guide* for additional CLI information.

For details on how to install Sun StorEdge Configuration Service, Sun StorEdge Diagnostic Reporter, or the Sun StorEdge CLI software, refer to the *Sun StorEdge 3000 Family Software Installation Manual*.

5.2 Monitoring with the Sun StorEdge Configuration Service

Sun StorEdge Configuration Service supports standalone JBOD arrays. However, because the Sun StorEdge 3120 SCSI array does not have a RAID controller or RAID controller firmware to manage the disks, this software support is limited to enabling JBOD support and viewing component and alarm characteristics.

See [“Viewing Component and Alarm Characteristics” on page 5-4](#).

5.2.1 Enabling JBOD Support

Use JBOD support only when you have a SCSI array connected directly to a host. This enables you to monitor peripheral device condition and events.

Note – Enabling JBOD support may impact I/O performance.

To monitor peripheral device condition and events for a JBOD device from the Sun StorEdge Configuration Service Console, you first need to enable JBOD support.

1. **Select View → Agent Options Management.**

The Agent Options Management window is displayed.

2. **Select the Enable JBOD Support check box.**

3. **To immediately display the JBOD in the main window, you need to probe for new inventory. Select View → View Server and click Probe.**

4. **Click OK.**

The JBOD is displayed in the main window.

In a single-bus configuration, both ports of the JBOD array are connected to one HBA on the server, as shown in the following example.

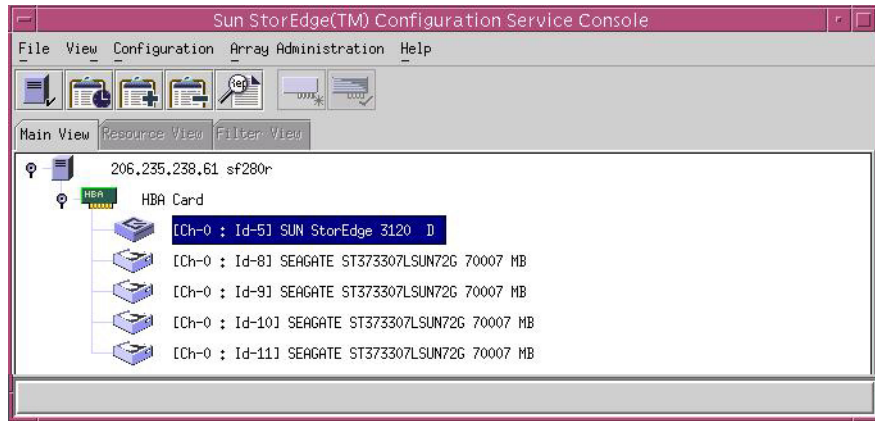

FIGURE 5-1 Single-Bus Configuration

In a split-bus, dual-server configuration, each port is connected to its own HBA, as shown in the following example. A SAF-TE limitation prevents the main window from showing the drives connected to port A and port B. The program can only monitor the JBOD from the server connected to port B as shown

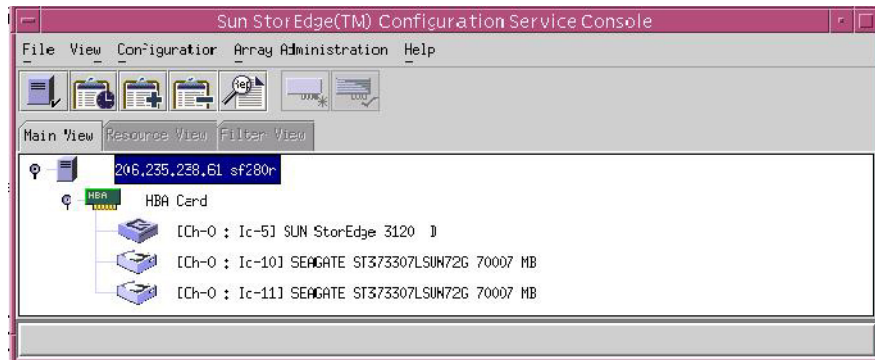

FIGURE 5-2 Split-Bus, Dual-Server Configuration

Note – In a split-bus configuration, if each port is connected to different servers, the program can only monitor the JBOD from the server connected to port B.

In a split-bus, single-server configuration, shown in [FIGURE 5-3](#), Sun StorEdge Configuration Service compensates for the SAF-TE limitation and displays all the drives connected to port A and port B.

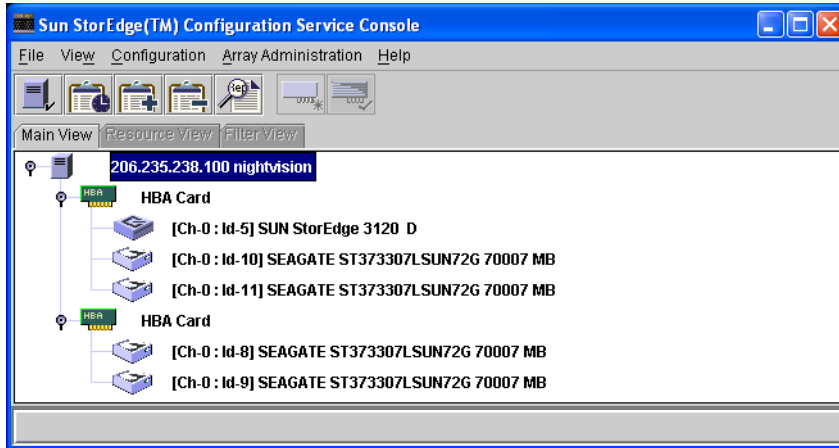

FIGURE 5-3 Split-Bus, Single-Server, Dual HBA Configuration

5.2.2 Viewing Component and Alarm Characteristics



In Sun StorEdge Configuration Service, to view environmental component and alarm characteristics, use the View Enclosure window or, for some components, the main window.

You can also view environmental and drive components using the Sun StorEdge CLIL `show enclosure-status` command. For details, see [“show enclosure-status” on page 5-12](#).

Main Window

In the main window, device states are color-coded and symbol-coded so that it is easy to identify when a device is in a state that requires attention. The status is propagated along the device tree, enabling you to trace a failure down to the device level. See [TABLE 5-1](#) for device status details.

TABLE 5-1 Device Status State

Color	Symbol	State
Purple	None	The group, server, or device is online.
White	None	The user has not logged into this server.
Yellow		One or more components of this group or server are not working properly, but the array is still functional.
Red		One or more components of this group or server are not working. For instance, a disk drive failure or an enclosure with a failed fan would warrant a critical state icon.
Gray		The group, server, or device is unresponsive.

To view the cause of a critical or degraded device status, review the event log. For details on the event log, refer to the *Sun StorEdge 3000 Family Configuration Service User's Guide*.

View Enclosure Window

The View Enclosure window displays the component and alarm characteristics for a JBOD device. The window displays the status for environmental components including the fan, power supply, and temperature sensor.

To view the environmental component and alarm characteristics of a SCSI array from the Sun StorEdge Configuration Service Console, perform the following steps.

1. **Select the EMU (SCSI) or SES (Fibre Channel) icon** .
2. **Choose View → View Enclosure.**

To display FRU ID information, click View FRU.

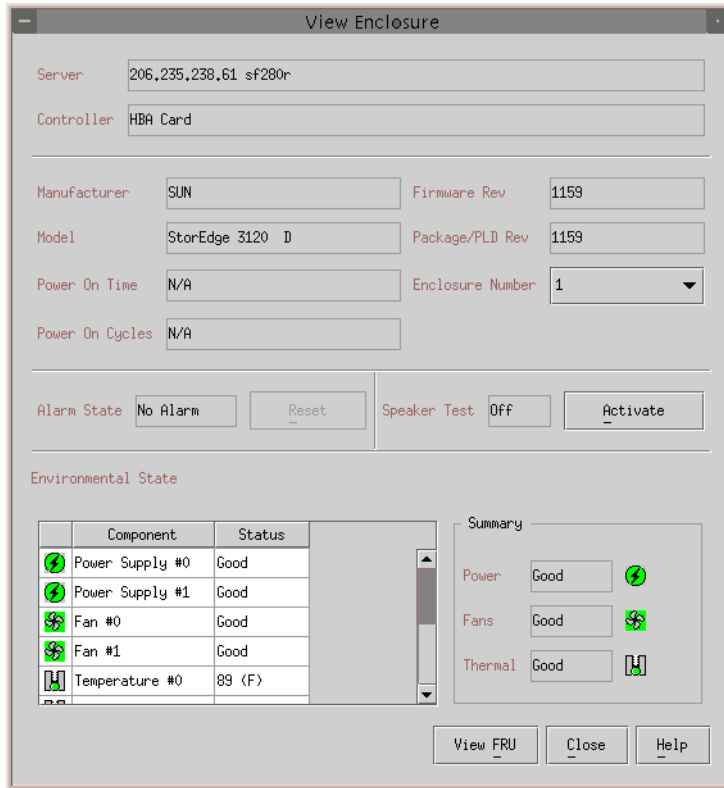

FIGURE 5-4 View Enclosure Dialog Box

5.3 Event Messages from the Sun StorEdge Diagnostic Reporter

Sun StorEdge Diagnostic Reporter supports standalone JBOD arrays. However, triggered event notification is limited to environmental and hard drive failures. Refer to the *Sun StorEdge 3000 Family Diagnostic Reporter User's Guide* for more information.

5.4 Monitoring with the Sun StorEdge CLI

The Sun StorEdge CLI supports JBOD arrays. However, because JBOD arrays do not have a RAID controller or RAID controller firmware to manage the disks, this CLI support is limited to the following `sccli` commands:

- `about`
- `exit`
- `help`
- `quit`
- `select`
- `set led`
- `show configuration`
- `show enclosure-status`
- `show frus`
- `show inquiry-data`
- `show led-status`
- `show safte-devices`
- `version`

about

The `about` command displays version and copyright information.

```
about
```

The following example shows the `about` text for the CLI:

```
sccli> about
Sun StorEdge 3000 Family CLI
Copyright 2002 Dot Hill Systems Corporation.
All rights reserved. Use is subject to license terms.
sccli version 1.6.0
built 2004.01.26.23.49
```

exit

This command exits the interactive mode.

```
exit
```

help

The `help` command displays a short synopsis of the available commands.

```
help [command]
```

If no command is specified, basic usage information is displayed.

quit

The `quit` command exits the interactive mode.

```
quit
```

select

The `select` command selects a new device to which subsequent commands are issued. If no device is specified, and more than one choice exists, a menu of choices is displayed. This command should not be used on the command line because a `select` command is implicitly done if no device name is specified.

```
select device
```

The following command selects an in-band SCSI JBOD device.

```
sccli> select /dev/es/ses0  
sccli: selected device /dev/es/ses2 [SUN StorEdge 3120 D SN#00029F]
```

set led

This command illuminates the LED in the enclosure adjacent to the specified disk (or slot). For JBODs, specify a disk device using a Solaris device name such as `sd31` or `c1t0d0s2`, or specify a slot number. Use the `show led-status` command to show the status of the identified disk drive.

Note – Selecting a slot by disk name is not supported in split-bus (dual-bus) enclosure configurations because the enclosure services processor resides on only one of the internal buses and the CLI may not be able to unambiguously determine the slot location of a particular device. In such configurations, use the `show enclosure-status` command and the documentation provided with your enclosure to determine the correct slot number instead.

To illuminate a disk drive LED, use the following parameters:

```
set led {slot n | disk sdn | disk cXtYdZ} {on | off}
```

In the following example, the LED adjacent to the drive with SCSI address 3 in the enclosure is set to on:

```
sccli> set led slot 3 on  
(enclosure sn 006498) led-slot-3: on
```

TABLE 5-2 Arguments for `set led`

Argument	Description
<code>slot <i>n</i></code>	Illuminates the drive LED for specified disk drive slot.
<code>disk <i>sdn</i></code>	Illuminates the drive LED for the specified Solaris disk drive slot.
<code>disk <i>cXtYdZ</i></code>	Illuminates the drive LED for the specified Solaris disk drive slot.
<code><i>ch.id</i></code>	Illuminates the drive LED for the specified drive within a RAID subsystem.
<code>{on off}</code>	Specify whether to illuminate the drive LED.

show configuration

This command displays the array configuration including inquiry information, FRU information, and the enclosure status which includes the status for the fan, power supply, temperature sensor, and drive slots. The configuration can be displayed onscreen, or written to the specified file. The output is plain text by default, but XML output may be obtained by specifying the `--xml` option.

```
show configuration [--xml | -x] [filename]
```

TABLE 5-3 Arguments for `show configuration`

Argument	Description
<code>{-xml -x}</code>	If the <code>-x</code> or <code>--xml</code> options are specified, XML output is generated.
<i>filename</i>	Specify the filename for the configuration file that you want to show.

Enclosure status values include:

Status	Description
OK	This component has a status of OK.
Absent	This component is absent.
Fault	The component is exhibiting a fault condition.
Unknown	This component status is not available.

The following example writes the configuration information to the `myconfig.xml` file.

```
# sccli c2t0d0 show configuration --xml myconfig.xml
```

The following example shows a portion of the JBOD configuration.

```
sccli> show configuration

* inquiry-data

Vendor: SUN
Product: StorEdge 3120 D
Revision: 1159
Peripheral Device Type: 0x3
Page 80 Serial Number: 006498
Device Type: Enclosure

* enclosure-status

  Id  Chassis  Vendor  Product ID          Rev  Package  Status
-----
   6  006498   SUN    StorEdge 3120 D    1159  1159      OK

Enclosure Component Status:
  Type Unit Status  FRU P/N  FRU S/N  Add'l Data
-----
  Fan 0   OK    370-5638 000236  --
  Fan 1   OK    370-5638 000287  --
  PS 0    OK    370-5638 000236  --
  PS 1    OK    370-5638 000287  --
  Temp 0  OK    370-6195 006498  temp=31
  Temp 1  OK    370-6195 006498  temp=30
  Temp 2  OK    370-5638 000236  temp=28
  Temp 3  OK    370-6195 006498  temp=31
  Temp 4  OK    370-6195 006498  temp=30
  Temp 5  OK    370-6195 006498  temp=30
  Temp 6  OK    370-5638 000287  temp=28
  DiskSlot 0  OK    370-6195 006498  addr=12,led=off
  DiskSlot 1  OK    370-6195 006498  addr=13,led=off
  DiskSlot 2  OK    370-6195 006498  addr=14,led=off
  DiskSlot 3  OK    370-6195 006498  addr=15,led=off
  ...
```

show enclosure-status

The `show enclosure-status` command shows the status for all chassis components including SAF-TE information, fan, power supply, temperature sensor, and drive slot status.

Note – In split-bus configurations, half the drives display a status of Absent. The drives are present, but because of a SAF-TE design limitation, the information does not display.

```
show enclosure-status
```

Enclosure status values include:

Status	Description
OK	This component has a status of OK.
Absent	This component is absent.
Fault	The component is exhibiting a fault condition.
Unknown	This component status is not available.

Disk slots refer to the backplane FRU to which disks are connected.

Note – The Enclosure SCSI Channel Type values include single-bus and split-bus. Throughout the documentation and the CLI, the term “split-bus” is interchangeable with the term “dual-bus.” For details on configuring an array, see [“Connecting Sun StorEdge 3120 SCSI Arrays to Hosts” on page 4-8.](#)

The following example shows the enclosure status for a Sun StorEdge 3120 SCSI device.

```

sccli> show enclosure-status
-----
  Id Chassis Vendor Product ID          Rev Package Status
-----
   6 006498  SUN   StorEdge 3120  D 1159 1159      OK

Enclosure Component Status:
  Type Unit Status  FRU P/N  FRU S/N  Add'l Data
-----
   Fan 0   OK    370-5638 000236  --
   Fan 1   OK    370-5638 000287  --
   PS 0    OK    370-5638 000236  --
   PS 1    OK    370-5638 000287  --
   Temp 0  OK    370-6195 006498  temp=30
   Temp 1  OK    370-6195 006498  temp=30
   Temp 2  OK    370-5638 000236  temp=30
   Temp 3  OK    370-6195 006498  temp=30
   Temp 4  OK    370-6195 006498  temp=30
   Temp 5  OK    370-6195 006498  temp=30
   Temp 6  OK    370-5638 000287  temp=28
  DiskSlot 0 OK    370-6195 006498  addr=12,led=off
  DiskSlot 1 OK    370-6195 006498  addr=13,led=off
  DiskSlot 2 OK    370-6195 006498  addr=14,led=off
  DiskSlot 3 OK    370-6195 006498  addr=15,led=off

Enclosure SCSI Channel Type: single-bus

```

show frus

This command displays field-replaceable units (FRU) ID and status information. All FRU information is retrieved from the SAF-TE device.

```

show frus

```

FRU status values include:

Status	Description
OK	All subcomponents of this FRU have a status of OK.
Fault	One or more of the FRU components is exhibiting a fault condition.

The following examples return all FRU information for the JBOD unit:

```
# sccli c2t0d0 show frus
```

```
# sccli /dev/scsi/processor/c6t15d0 show frus
```

The following example shows a partial list of the FRUs in a Sun StorEdge 3120 SCSI device:

```
sccli> show frus
3 FRUs found in chassis SN#006498
Name: JBOD_CHASSIS_BKPLN
Description: SE3120 JBOD Chassis
Part Number: 370-6195
Serial Number: 006498
Revision: 01
Manufacturing Date: Thu Jan 15 07:33:19 2004
Manufacturing Location: Milpitas California, USA
Manufacturer JEDEC ID: 0x0301
FRU Location: 1U SCSI JBOD MIDPLANE SLOT
Chassis Serial Number: 006498
FRU Status: OK

Name: AC_POWER_SUPPLY
Description: SE3110 AC PWR SUPPLY/FAN MOD
Part Number: 370-5638
Serial Number: 000236
Revision: 01
Manufacturing Date: Tue Jul 8 22:14:33 2003
Manufacturing Location: Irvine California, USA
Manufacturer JEDEC ID: 0x048F
FRU Location: 1U AC PSU SLOT #0 (LEFT)
Chassis Serial Number: 006498
FRU Status: OK

Name: AC_POWER_SUPPLY
Description: SE3110 AC PWR SUPPLY/FAN MOD
Part Number: 370-5638
Serial Number: 000287
. . .
```

show inquiry-data

This command displays the SCSI inquiry data. The output of this command varies from one product to another, and from one channel to another.

```
show inquiry-data
```

The following example shows an in-band Sun StorEdge 3120 SCSI array inquiry.

```
sccli> show inquiry-data  
Vendor: SUN  
Product: StorEdge 3120 D  
Revision: 1159  
Peripheral Device Type: 0x3  
Page 80 Serial Number: 006498  
Device Type: Enclosure
```

show led-status

This command displays the status of the LED adjacent to the specified disk drive slot in the array enclosure or expansion chassis.

To show the status of LVD JBOD enclosures, use the following parameters:

```
show led-status {slot n | disk sdn | disk cXtYdZ}
```

The following example shows the status of the LED adjacent to the disk assigned to drive slot 3 for an expansion chassis:

```
sccli> show led-status slot 3  
(enclosure sn 006498) led-slot-3: on
```

TABLE 5-4 Arguments for `show led-status`

Argument	Description
<code>slot n</code>	Shows the status for the LED adjacent to the specified disk drive slot. This argument is not accepted for RAID controllers.
<code>disk sdn</code>	Shows the status for the LED adjacent to the specified Solaris disk drive slot. This argument is not accepted for split-bus chassis.
<code>disk cXtYdZ</code>	Shows the status for the LED adjacent to the specified Solaris disk drive slot. This argument is not accepted for split-bus chassis.
<code>ch.id</code>	Shows the status for the LED adjacent to the specified drive within a RAID subsystem.

`show safte-devices`

This command displays information returned by the SAF-TE device embedded in SCSI LVD RAID enclosures or JBODs.

The output includes the serial number of the chassis in which it is installed, the vendor and product IDs and SAF-TE firmware revision, and the “SAF-TE firmware package” revision, which refers to firmware for other microprocesses in the chassis that are managed by the SAF-TE processor.

```
show safte-devices
```

The following example shows the SAF-TE device information for a Sun StorEdge 3120 SCSI array.

```
sccli> show safte-devices
  Id  Chassis  Vendor  Product ID          Rev  Package
-----
   6  006498   SUN    StorEdge 3120  D  1159  1159
```

version

The version command displays the version number of the CLI.

```
version
```

For example:

```
sccli> version  
sccli version 1.6.0
```

5.5 Managing Disks in the Sun StorEdge 3120 SCSI Array

Use your standard host system disk management utilities for all disk management in a JBOD array, such as partitioning and formatting. Refer to your host system documentation for more information about disk management.

For maintenance and troubleshooting information, see [“Maintaining and Troubleshooting Your Array” on page 7-1](#).

5.6 Enabling VERITAS DMP in a Single-Bus Configuration

The Sun StorEdge 3120 SCSI array supports Veritas Dynamic Multi-Pathing (DMP) software.

Note – For other supported software, see the Release Notes for your array.

To enable VERITAS Dynamic Multi-Pathing (DMP) support on VERITAS Volume Manager Version 3.2, ensure the HBA device SCSI initiator IDs are unique and then start the system. Perform the following steps.

1. Create a single-bus, multi-initiator configuration that links two cables to two different HBAs.

For details about creating a single-bus multi-initiator configuration, see [“A Single-Bus, Multi-Initiator JBOD Configuration” on page 4-14.](#)

2. Stop the server and at the ok prompt, type:

```
ok setenv auto-boot? false
ok reset-all
ok probe-scsi-all
```

3. Issue the remaining commands on only one of the paths.
4. Edit or create the nvramrc to set the SCSI-initiator-id to a non-conflicting ID for these devices based on the information returned in step 2.
5. From the OBP type:

```
ok nvedit
0: probe-all install-console banner
1: cd /pci@6,4000/scsi@3 *** your path information here ***
2: 6 " scsi-initiator-id" integer-property
3: device-end
4: banner (Ctrl-c)
```

6. Press Ctrl-c, and store the nvramrc by typing:

```
ok nvstore
```

7. Set the system to use the nvramrc and reset auto-boot by typing:

```
ok setenv use-nvramrc? true
ok setenv auto-boot? true
```

8. Reset the configuration by typing:

```
ok reset-all
```

9. Reboot the hosts. A system reboot is required to implement these changes.

Note – SCSI arrays require a license from VERITAS in order to enable any of its advanced features. Refer to VERITAS Volume Manager Release Notes or contact VERITAS Software Corporation for licensing terms and information.

Checking LEDs

This chapter describes the front-panel and back-panel LEDs, which give the clear status of the operation of all drives and modules. Topics covered in this chapter include:

- “LEDs When Array Is First Powered On” on page 6-1
- “Front-Panel LEDs” on page 6-2
- “Back-Panel LEDs” on page 6-4

6.1 LEDs When Array Is First Powered On

With the array powered on without the SCSI bus configuration cable installed while the array is not connected to a server, you should see the LED conditions described in [TABLE 6-1](#) and [TABLE 6-2](#).

TABLE 6-1 Front-Panel LED Status When Array Is First Powered On

Drive LEDs	Solid green
Chassis ear LEDs	Solid green

TABLE 6-2 Back-Panel LED Status When Array Is First Powered On

I/O Module:	
ERROR LED	Blinking green (no bus configuration; invalid state)
TERM LED	Solid green (autotermination enabled)
	Inactive (no bus configuration; invalid state)
Power/fan module LEDs	Solid green

6.2 Front-Panel LEDs

The drive LEDs are located between the rows of drives on the front panel (see the following figure). The system operation LEDs are located on the right ear of the chassis.

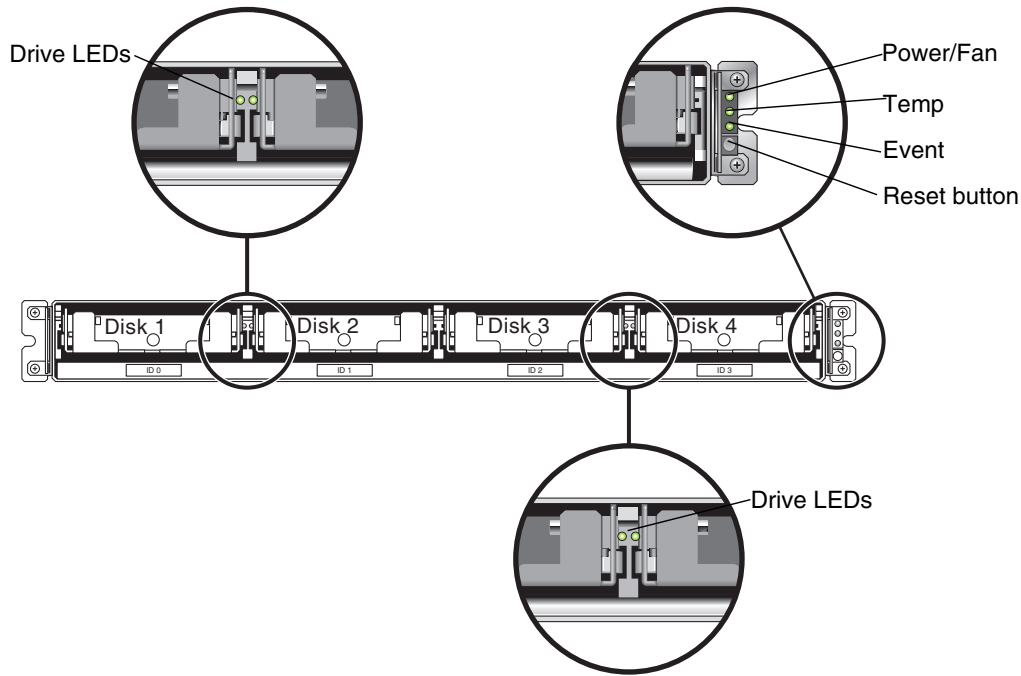

FIGURE 6-1 Front-Panel LEDs

The following figure shows the front-panel LEDs and Reset button.

Use the Reset button to silence an alarm. For alarm details, see [“Silencing Audible Alarms”](#) on page 7-3.

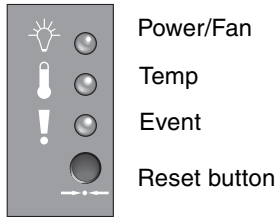

FIGURE 6-2 Chassis Ear LEDs and Reset Button on Front Panel

The following table lists the front-panel LEDs.

TABLE 6-3 Front Panel LEDs

LED	LED Color	Description
Drive	Solid green Blinking green Solid amber	Good: Drive power-up and spin-up OK. Good: Drive activity. Failed: Drive failure.
Power (Light bulb icon) Monitors the DC output voltage within tolerance specification. Overcurrent protection shutting down any voltage output displayed. Voltage thresholds: +5 VDC +/- .25 VDC +12 VDC +/- .6 VDC Current thresholds: +5 VDC 20A +12 VDC 12A	Solid green Solid amber	Power supply good. Failed: One or more output voltages out of range.
Temp (Thermometer icon) Monitors the temperature level and indicates violations of internal temperature thresholds of 55C and 60C.	Solid green Solid amber	Good: Under temperature threshold of 55C. Failed: Temperature threshold equal to or over 55C.
Event (Caution icon) Indicates any abnormal or failure event.	Solid green Solid amber	Normal operation. Abnormal environment event.

Note – To test that the front-panel LEDs work, press and hold the Reset button for 5 seconds. All the LEDs should change from green to amber when you perform this test. Any LED that fails to light indicates a problem with the LED. When you release the Reset button, the LEDs return to their initial state.

6.3 Back-Panel LEDs

The back-panel LED colors indicate the conditions described in the following figures and tables. The following figure is the back-panel with LEDs.

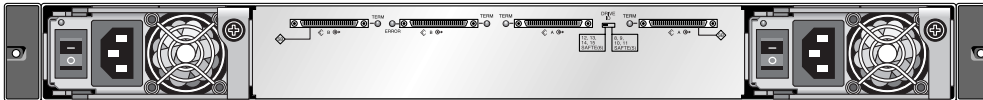

FIGURE 6-3 Back-Panel LEDs

TABLE 6-4 Back-Panel Module LEDs

Module	LED Color	Status
Power supply/fan		
Monitors the DC output voltage within tolerance specification. Overcurrent protection shutting down any voltage output will also be displayed. Voltage thresholds: +5 VDC +/- .25 VDC +12 VDC +/- .6 VDC Current Thresholds: +5 VDC 20A +12 VDC 12A	Solid green	Power supply good.
	Solid amber	Failed: one or more output voltages out of range.
	Solid green	Good fan: Over 900 RPM.
	Solid amber	Faulty/failed: Under 900 RPM.
I/O module		
TERM LEDs	Solid green Inactive LED	Autotermination enabled. Autotermination disabled.
ERROR LED	Blinking green Solid amber Inactive LED	Invalid single- or dual-cable configuration. Failed I/O module. Valid single- or split-bus configuration, and I/O module is good.



Caution – If you see a blinking green or amber LED, you might have an incorrect configuration or a failed component.

The AC and DC power supply and fan modules have a single LED.

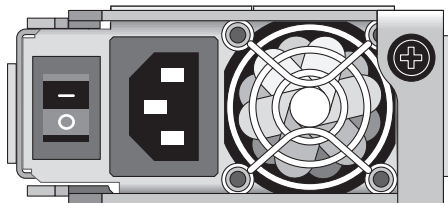

FIGURE 6-4 AC Power Supply and Fan Module

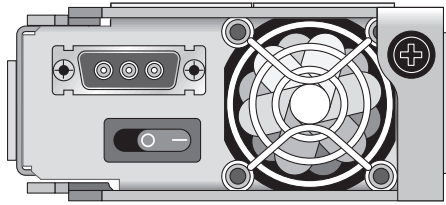

FIGURE 6-5 DC Power Supply and Fan Module

The I/O modules for JBOD units have TERM and ERROR LEDs.

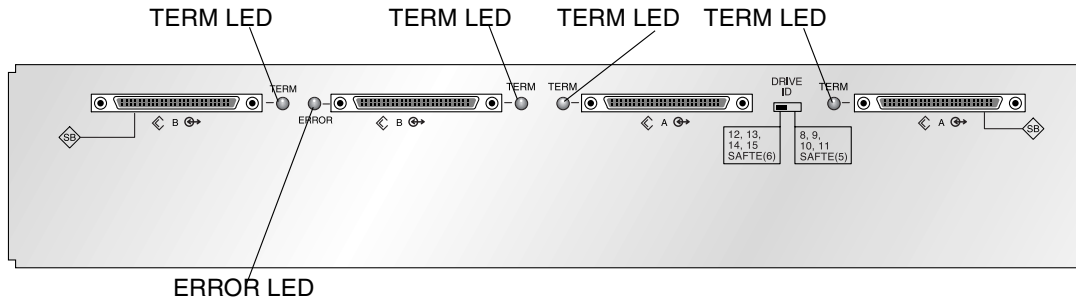

FIGURE 6-6 JBOD I/O Module

Maintaining and Troubleshooting Your Array

This chapter describes troubleshooting procedures and error messages you can use to isolate configuration and hardware problems as well as maintenance procedures. This chapter covers the following topics:

- [“Upgrading Firmware” on page 7-2](#)
- [“Failed Component Alarms” on page 7-2](#)
- [“Silencing Audible Alarms” on page 7-3](#)
- [“General Troubleshooting Guidelines” on page 7-4](#)
- [“Writing Events to a Log File for an IBM AIX Host” on page 7-5](#)
- [“Troubleshooting Solaris Operating System Configuration Issues” on page 7-6](#)
- [“JBOD Disks Not Visible to the Host” on page 7-6](#)
 - [“Making JBODs Visible to Hosts Running the Solaris Operating System” on page 7-7](#)
 - [“Making JBODs Visible to Hosts Running the Windows NT Operating System” on page 7-7](#)
 - [“Making JBODs Visible to Hosts Running the Windows 2000 and Windows 2003 Operating Systems” on page 7-10](#)
 - [“Making JBODs Visible to Hosts Running the Linux Operating System” on page 7-14](#)
 - [“Making JBODs Visible to Hosts Running the HP-UX Operating System” on page 7-15](#)
 - [“Making JBODs Visible to Hosts Running the IBM AIX Operating System” on page 7-15](#)
- [“Identifying a Failed Drive for Replacement” on page 7-17](#)
- [“Verifying Operating System Device Information” on page 7-17](#)
- [“JBOD Troubleshooting Decision Trees” on page 7-19](#)

To check front-panel and back-panel LEDs, see “Checking LEDs” on page 6-1.

For more troubleshooting tips, refer to the *Sun StorEdge 3120 SCSI Release Notes* at:

http://www.sun.com/products-n-solutions/hardware/docs/Network_Storage_Solutions/Workgroup/3120

7.1 Upgrading Firmware

Firmware upgrades are made available as patches that you can download from the Sun web site, located at:

<http://sunsolve.Sun.COM>

Each patch applies to a particular type of firmware, including:

- Drive firmware
- SAF-TE firmware (SCSI only)

Each patch includes an associated README text file that provides detailed instructions about how to download and install that patch. Firmware downloads follow the same general steps:

- Locating the patch that contains the firmware upgrade you want.
- Downloading the patch to a location on your network.
- Following the directions in the README patch text file to load the firmware upgrade.

7.2 Failed Component Alarms

Failed component alarm tones use Morse code dot and dash characters. The dot “.” is a short tone sounding for one unit of time. The dash “-” is a long tone sounding for three units of time.

Alarms, also referred to as beep codes, are presented in a sequence, starting with the critical component failure alarm, which alerts you to a component problem or failure or a firmware mismatch. This alarm is then followed by alarms for whichever components or assemblies have failed. Once the beep code sequence is complete, it repeats. To understand the beep codes, listen to the sequence of codes until you can break down the sequence into its separate alarms. You can also check your software or firmware for alarms, error messages, or logs to isolate and understand the cause.

For example, in the case of a fan failure in a power supply, you might first hear the critical component failure alarm, followed by a power supply failure alarm from power supply 0 or power supply 1, followed by a fan failure event alarm, followed by an event alarm. This sequence will continue to repeat.

TABLE 7-1 Failed Component Alarm Codes

Failure	Morse Code Letter	Morse Code Sound Pattern
Critical component failure or mismatch	8 dashes	-----
Power supply 0 failure	P0	. - . - - - -
Power supply 1 failure	P1	. - - . . - - -
Event alarm	E	.
Fan failure	F
Voltage failure	V	. . . -
Temperature failure	T	-

7.3 Silencing Audible Alarms

An audible alarm indicates that an environmental component in the array has failed. These error conditions and events are reported by event messages and event logs. Component failures are also indicated by LED activity on the array.

To silence the alarm:

1. **Use a paperclip to push the Reset button on the right ear of the array.**

For details about where the Reset button is located, see [“Front-Panel LEDs” on page 6-2](#).

2. **Check the front-panel and back-panel LEDs to determine the cause of the alarm.**

For more information, see [“Checking LEDs” on page 6-1](#).

3. **In Sun StorEdge Configuration Service, check the event log to determine the cause of the alarm.**

Component event messages include but are not limited to the following terms:

- Temperature
- Cooling element
- Power supply
- Fan

- Voltage sensor

For details about using Sun StorEdge Configuration Service to determine the cause of an alarm, see [“Viewing Component and Alarm Characteristics” on page 5-4](#).



Caution – Be particularly careful to observe and rectify a temperature failure alarm. If you detect this alarm, shut down the JBOD and the server as well if it is actively performing I/O operations to the affected array. Otherwise system damage and data loss can occur.

7.4 General Troubleshooting Guidelines

When a problem is not otherwise reproducible, suspect hardware may need to be replaced. Always make only one change at a time and carefully monitor results. When possible, it is best to restore the original hardware before replacing another part to eliminate the introduction of additional unknown problem sources.

After hardware replacement, a problem can usually be considered solved if it does not resurface during a period equal to twice its original frequency of occurrence. For example, if a problem was occurring once a week on average before a potential fix was made, running two weeks without seeing the problem again suggests a successful fix took place.

Troubleshooting hardware problems is usually accomplished by a FRU isolation sequence that uses the process of elimination. Set up a minimal configuration that shows the problem and then replace elements in this order, testing after each replacement until the problem is solved:

- Replace the cables.
- Replace the drives.
- Replace the HBAs.

Often you can also find out what causes a hardware problem by determining the elements that do not cause it. Start out by testing the smallest configuration that does work, and then keep adding components until a failure is detected.

To view error messages reported by JBODs, use any of the following:

- Message log in the operating system
 - For Solaris, `/var/adm/messages`
 - For Linux, `/var/log/message`
 - For Windows, use the event viewer
 - For HP-UX, `/var/adm/syslog/syslog.log`
 - For IBM AIX, see [“Writing Events to a Log File for an IBM AIX Host” on page 7-5](#).
- Sun StorEdge Configuration Service event log

For more information about replacing the chassis, see [“Installing a JBOD Chassis FRU” on page 8-11](#).



Caution – Back up the chassis data onto another storage device prior to replacing a disk drive to prevent any possible data loss.

Before you begin troubleshooting JBODs, check the cables that connect the host to the JBOD. Look for bent pins, loose wires, loose cable shields, loose cable casing and any cables with 90 degree or more bends in them. If you find any of these problems, replace the cable.

The [FIGURE 7-1](#) flowchart provides troubleshooting procedures specifically for JBODs.

7.4.1 Writing Events to a Log File for an IBM AIX Host

For an IBM AIX operating system, the event logs are not logged by default. You might need to change `/etc/syslog.conf` to enable it to write to a log file.

1. **Modify `/etc/syslog.conf` to add the following line:**

```
*.info /tmp/syslog rotate size 1000k
```

2. **Make sure the file that is specified in the added line exists.**

If it does not exist, you need to create it. For example, in the above configuration, you would create a file named `/tmp/syslog`.

3. **Change to `/tmp/syslog` and restart the `syslog` by typing:**

```
kill -HUP `cat /etc/syslog.pid`
```

7.5 Troubleshooting Solaris Operating System Configuration Issues

Follow this sequence of general steps to isolate software and configuration issues.

Note – Look for storage-related messages in `/var/adm/messages` and identify any suspect Sun StorEdge 3120 SCSI arrays.

1. **Check the Sun StorEdge Configuration Service Console for alerts or messages.**
2. **Check the LEDs.**
For more information, see “[Checking LEDs](#)” on page 6-1.
3. **In Sun StorEdge CLI, run the `show enclosure-status` command.**
For more information, see “[show enclosure-status](#)” on page 5-12.
4. **Check revisions of software package, patches, and hardware.**
5. **Verify the correct device file paths.**
6. **Check any related software, configuration, or startup files for recent changes.**
7. **Search SunSolve Online for any known related bugs and problems at:**
<http://sunsolve.Sun.COM>.

7.6 JBOD Disks Not Visible to the Host

If you attach a JBOD array directly to a host server and do not see the drives on the host server, check that the cabling is correct and that there is proper termination. See the special cabling procedures in “[Connecting Sun StorEdge 3120 SCSI Arrays to Hosts](#)” on page 4-8.

7.6.1 Making JBODs Visible to Hosts Running the Solaris Operating System

If the JBOD cabling is correct and the drives are still not visible, run the `devfsadm` utility to rescan the drives. The new disks can be seen when you perform the `format` command.

If the drives are still not visible, reboot the host(s) with the `reboot -- -r` command so that the drives are visible to the host.

7.6.2 Making JBODs Visible to Hosts Running the Windows NT Operating System

Before beginning this procedure, make sure that you are using a supported SCSI host bus adapter (HBA) such as an Adaptec 39160. Refer to the Release Notes for your array for current information about which HBAs are supported.

Also make sure that you are using a supported driver for your HBA. For the Adaptec 39160, use FMS V4.0a or later.

1. **Boot your system and verify that the host bus adapter (HBA) basic input/output system (BIOS) recognizes the new SCSI device.**

Note – While your system is starting, you will see the new SCSI device.

You are now ready to partition and format the new device.

2. **Open the Disk Administrator application.**
 - a. **Click Start**
 - b. **Choose Administrative Tools → Disk Administrator.**

A Disk Administrator is initializing progress indicator is displayed.

A Disk Administrator window then displays the drives recognized by the system.

3. Select the disk whose Free Space you want to partition and format.

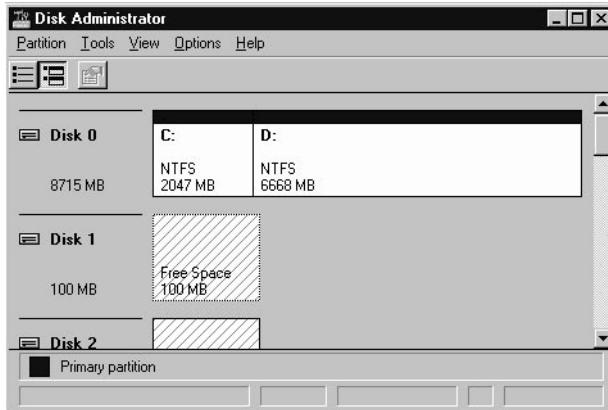

a. Choose Create from the Partition menu.

A **Create Primary Partition** window enables you to specify the size of the partition.

b. Specify a size or accept the default value.

c. Click OK to create the partition.

The partition is now identified as **Unformatted** in the **Disk Administrator** window.

4. Select the Unformatted partition.

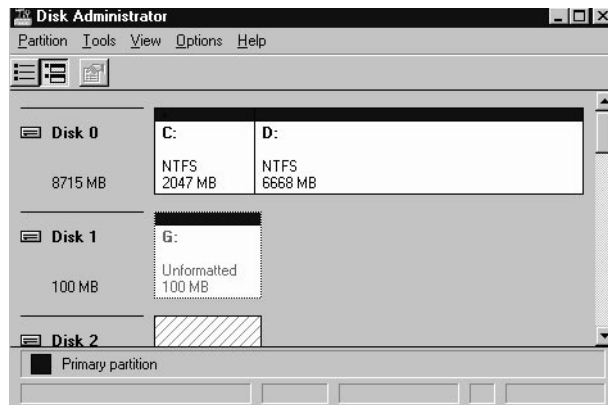

5. Choose Commit Changes Now from the Partition menu.

A confirmation dialog box is displayed.

6. Click Yes to save the changes you have made.

A dialog box confirms that the disks updated successfully.

7. Click OK.

The partition is now identified as Unknown in the Disk Administrator window.

8. Format the Unknown partition.

a. Select the Unknown partition.

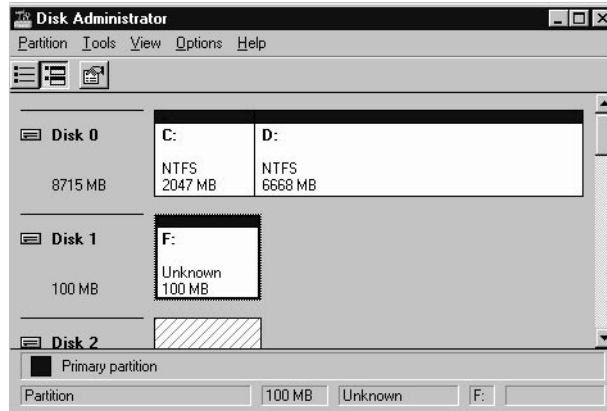

b. Choose Format from the Tools menu.

A Format dialog box is displayed.

c. Choose NTFS from the File System drop-down menu.

d. Make sure the Quick Format checkbox is checked.

e. Specify the settings you want and then click Start.

A dialog box warns you that any existing data on the disk will be erased.

f. Click OK to format the disk.

The new partition is formatted and a dialog box confirms that the format is complete.

9. Click OK.

The formatted partition is identified as NTFS in the Disk Administrator window.

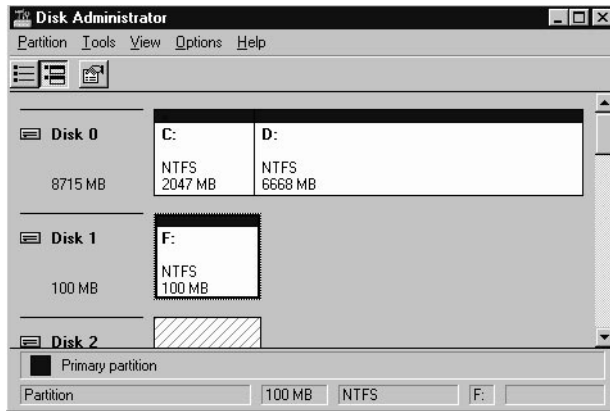

10. Repeat these steps for any other new partitions and devices you want to format.

7.6.3 Making JBODs Visible to Hosts Running the Windows 2000 and Windows 2003 Operating Systems

Before beginning this procedure, make sure that you are using a supported SCSI host bus adapter (HBA) such as an Adaptec 39160. Refer to the Release Notes for your array for current information about which HBAs are supported.

Also make sure that you are using a supported driver for your HBA. For the Adaptec 39160, use FMS V4.0a or later.

1. Boot your system and verify that the host bus adapter (HBA) basic input/output system (BIOS) recognizes the new SCSI device.

Note – While your system is starting up, you should see the new SCSI device.

2. If a Found New Hardware Wizard is displayed, click Cancel.
You are now ready to format your new device.
3. Open the Disk Management folder.
 - a. Right-click the My Computer icon and choose Manage.
 - b. Select the Disk Management folder.

c. If a Write Signature and Upgrade Disk Wizard is displayed, click Cancel.

A "Connecting to Logical Disk Manager Server" status message is displayed.

4. Select the new device when it is displayed.

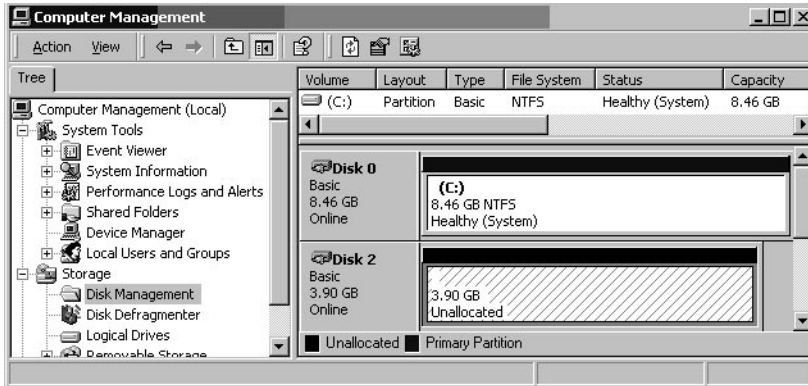

5. Right-click in the Unallocated partition of the device and choose Create Partition.

A Create Partition Wizard is displayed.

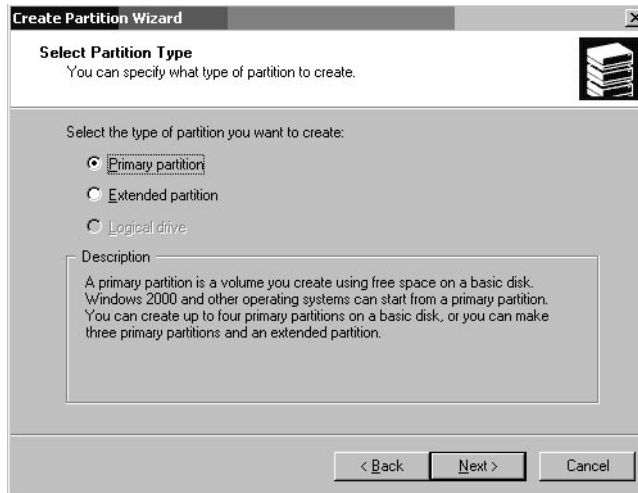

6. Click Next.

7. Choose Primary partition and click Next.

8. Specify the amount of disk space to use or accept the default value, and click Next.

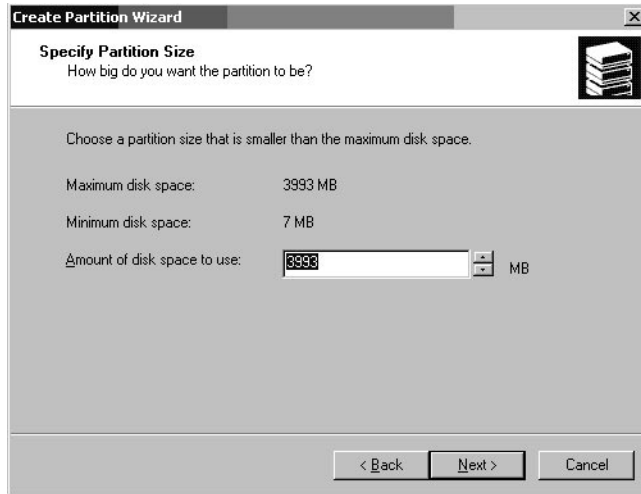

9. Assign a drive letter and click Next.
10. Choose Format this partition with the following settings.
 - a. Specify NTFS as the File system to use.
 - b. Make sure the Perform a Quick Format checkbox is checked.

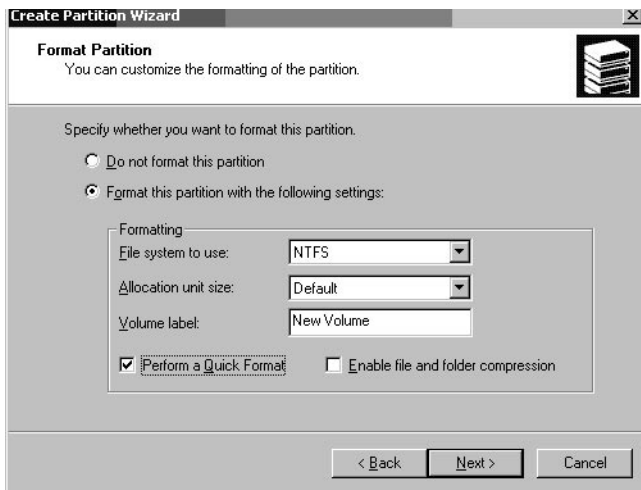

c. Click Next.

A confirmation dialog box displays the settings you have specified.

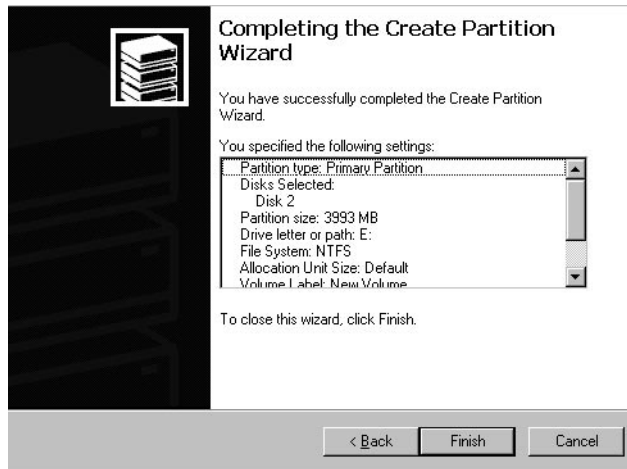

11. Click Finish.

The new partition is formatted and the formatted partition is identified as NTFS in the **Computer Management** window.

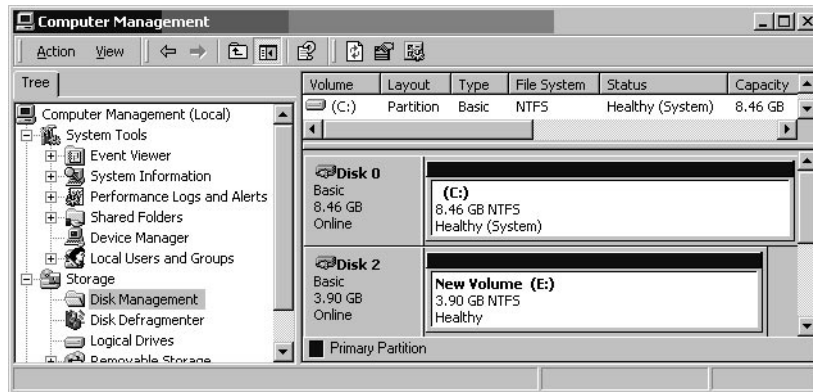

12. Repeat these steps for any other new partitions and devices you want to format.

7.6.4 Making JBODs Visible to Hosts Running the Linux Operating System

When booting the server, watch for the host bus adapter (HBA) card BIOS message line to display onscreen and then press the proper sequence of keys in order to get into the HBA BIOS: Key strokes for SCSI Adaptec cards = <Ctrl><A>.

The key strokes are listed onscreen when the adapter is initializing. After you enter the Adaptec HBA BIOS with <Ctrl><A>, perform the following steps.

1. **Highlight Configure/View Host Adapter Settings and press Return.**
2. **Go to Advanced Configuration Options and press Return.**
3. **Go to Host Adapter BIOS and press Return.**
 - a. **Select disabled:scan bus if this is not going to be a bootable device.**
 - b. **If it is going to be bootable device, select the default Enabled. The * represents the default setting.**
4. **Press Esc until you return to the main options screen where Configure/View Host Adapter Settings was located.**
5. **Select SCSI Disk Utilities and press Return.**

The BIOS will now scan the SCSI card for any SCSI devices attached to the HBA. You will see the HBA's SCSI ID as well as any other SCSI devices attached to the HBA. If you only see the HBA's SCSI ID, then something is not correct with the configuration on the SCSI attached device, or the cable between the HBA and the SCSI device is bad or not attached.
6. **If you are satisfied with the configuration, press Esc until a screen opens and displays Exit Utility?. Select Yes and press Return. A screen opens stating Please press any key to reboot. Press a key to reboot the server.**
7. **Repeat the same steps for every HBA that you want to attach to the Sun StorEdge 3120 JBOD array.**

7.6.5 Making JBODs Visible to Hosts Running the HP-UX Operating System

The following steps describe how to discover drives on systems running the HP-UX operating system.

1. Run the command:

```
# ioscan -fnC disk
```

2. If the drive is still not seen, the host might need to be rebooted. Run the commands:

```
# sync;sync;sync  
# reboot
```

7.6.6 Making JBODs Visible to Hosts Running the IBM AIX Operating System

The following steps describe how to discover drives on systems running the IBM AIX operating system.

Note – You must have superuser privileges to run these commands.

1. Create the logical drive and map its LUN to the correct host channel.
2. Run the command:

```
# cfgmgr
```

3. Run the command:

```
# lspv
```

Output similar to the following is displayed.

```
hdisk0 000df50dd520b2e rootvg  
hdisk1 000df50d928c3c98 None  
hdisk1 000df50d928c3c98 None
```

4. If any of the drives show “none,” you need to assign a Physical Volume IDENTIFIER.

5. Run the command:

```
# smitty
```

- a. Select Devices.
 - b. Select Fixed Disk.
 - c. Select Change/Show Characteristics of a Disk.
 - d. Select the disk without a pvid.
 - e. Select ASSIGN physical volume identifier, press Tab once to display Yes for the value, and press Return.
 - f. Press Return again to confirm and repeat steps a-f as necessary.
6. From the smitty main menu, select System Storage Management (Physical & Logical Storage) → Logical Volume Manager → Volume Groups → Add a Volume Group.
7. Specify a name for the volume group, make sure the partitions for the journaled file system are large enough, and select the Physical Volume Name(s).
8. From the smitty main menu, select System Storage Management (Physical & Logical Storage) → File Systems → Add / Change / Show / Delete File Systems → (Enhanced) Journaled File System.
9. Select the volume group and set the field.

Run the command:

```
# umount mount point
```

7.7 Identifying a Failed Drive for Replacement

You can identify a failed drive by checking:

- for an amber drive LED – For details, see [“Front-Panel LEDs” on page 6-2](#).
- Sun StorEdge Configuration Service (SSCS) – For more information, see [“Main Window” on page 5-4](#).
- Sun StorEdge CLI – For details about the `show enclosure-status` command, see [“show enclosure-status” on page 5-12](#).
- the Operating System device list – For details, see the following section, [“Verifying Operating System Device Information” on page 7-17](#).



Caution – You can mix capacity in the same chassis, but not spindle speed (RPMs) on the same SCSI bus. For instance, you can use 36 Gbyte and 73 Gbyte drives with no performance problems if both are 10K RPM drives. Violating this configuration guideline leads to poor performance.

7.7.1 Verifying Operating System Device Information

To identify failed disks, you can review the operating system device information to verify drive status.

- **In Solaris**, perform the `format` command. All attached disks are listed. Any failed devices or disks are indicated. For details on attaching new devices, see [“Making JBODs Visible to Hosts Running the Solaris Operating System” on page 7-7](#).
- **In Linux**, from the HBA BIOS, select Configure/View Host Adapter Settings and press Return. Select SCSI Disk Utilities and press Return. The BIOS scans the SCSI card for any SCSI devices attached to the HBA. The HBA’s SCSI ID is displayed as well as any other SCSI devices attached to the HBA. If you only see the HBA’s SCSI ID, then something is not correct with the configuration on the SCSI attached device, or the cable between the HBA and the SCSI device is bad or not attached. For details on attaching new devices, see [“Making JBODs Visible to Hosts Running the Linux Operating System” on page 7-14](#).
- **In Microsoft Windows**, boot your system and verify that the host bus adapter (HBA) basic input/output system (BIOS) recognizes the new SCSI device. For details on attaching new devices, follow the instructions in [“Making JBODs](#)

Visible to Hosts Running the Windows NT Operating System” on page 7-7 or in “Making JBODs Visible to Hosts Running the Windows 2000 and Windows 2003 Operating Systems” on page 7-10.

Note – While your system is starting, you will see the new SCSI device.

- **In HP-UX**, run the `ioscan -fnC disk` command. For details on attaching new devices, see “Making JBODs Visible to Hosts Running the HP-UX Operating System” on page 7-15.
- **In IBM AIX**, run `# cfgmgr` command followed by `# lspv`. For details on attaching new devices, see “Making JBODs Visible to Hosts Running the IBM AIX Operating System” on page 7-15.

7.8 JBOD Troubleshooting Decision Trees

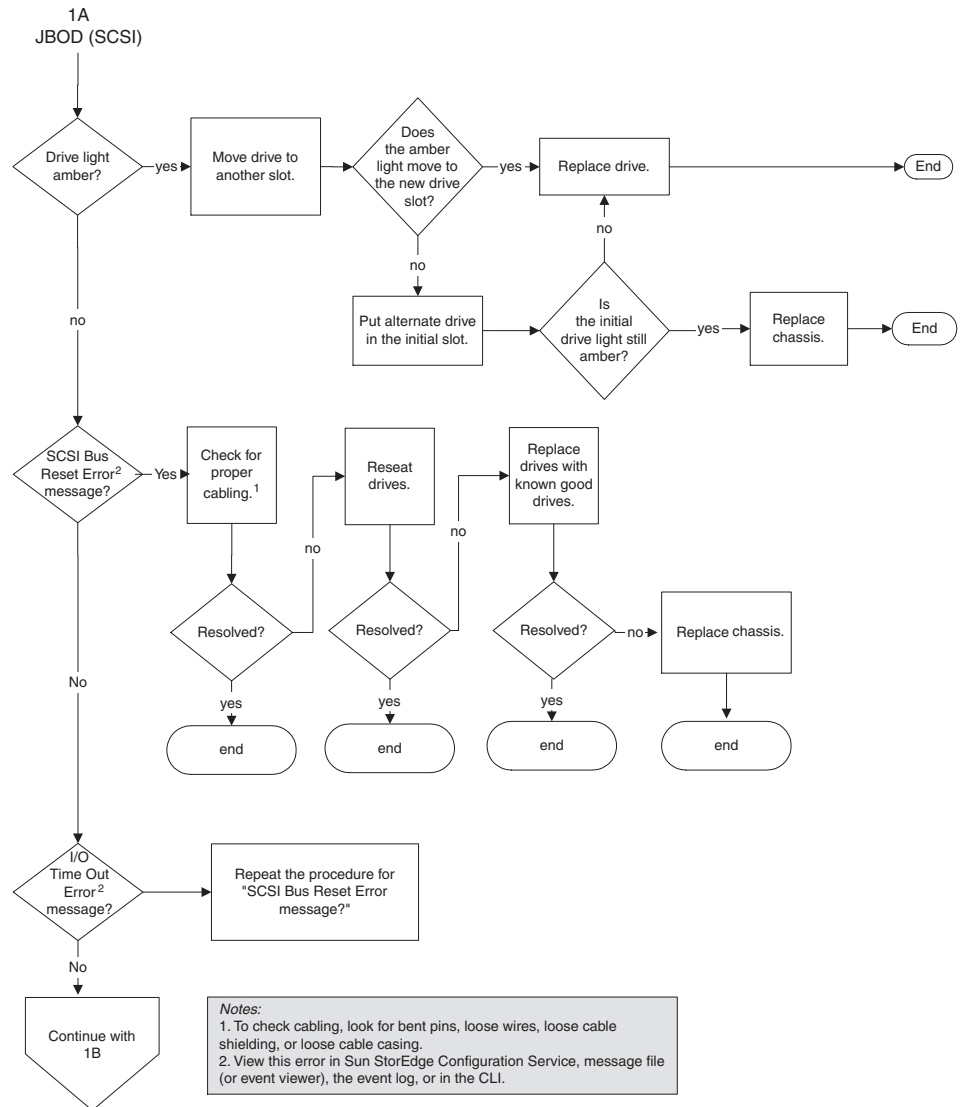

FIGURE 7-1 Troubleshooting Decision Tree for JBODs, Figure 1 of 2

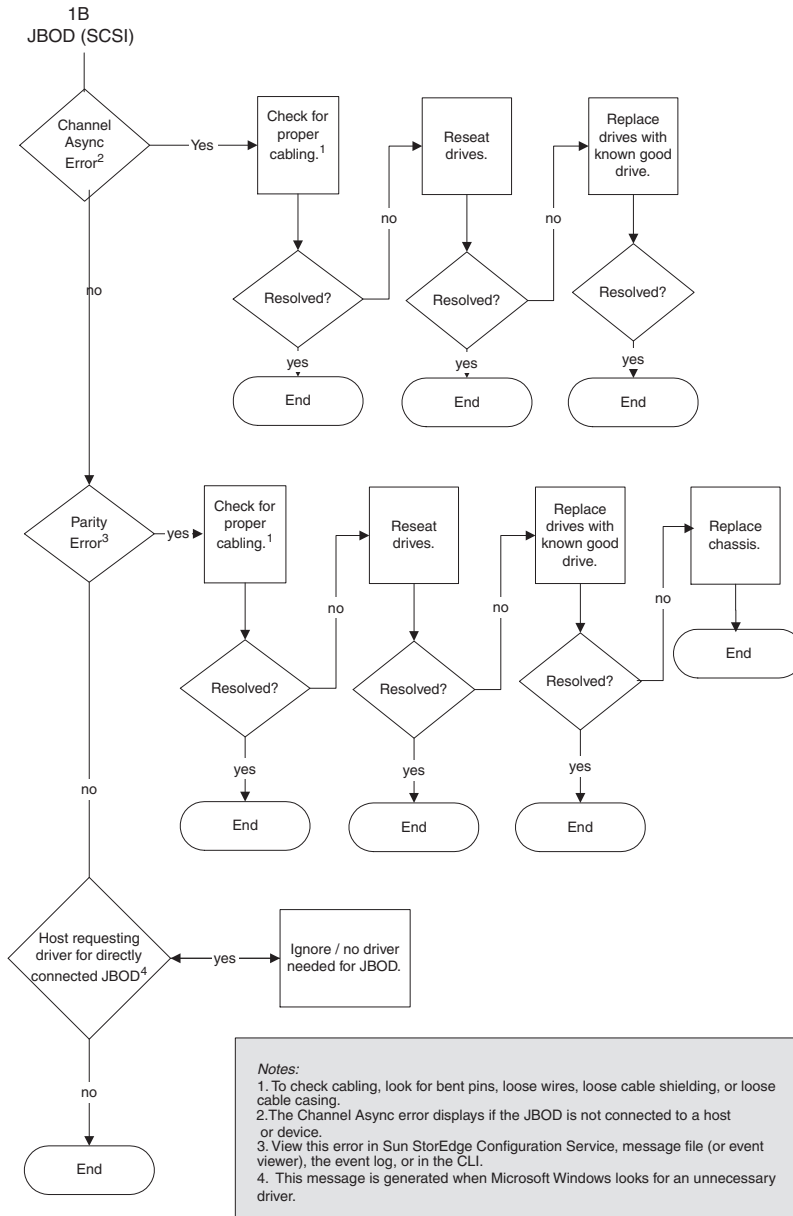

FIGURE 7-2 Troubleshooting Decision Tree for JBODs, Figure 2 of 2

Installing FRUs

This chapter provides instructions for removing and installing field-replaceable units (FRUs) in Sun StorEdge 3120 SCSI arrays. These FRU components can be replaced by customers or by Sun service representatives.

This chapter covers the following topics:

- [“Available FRUs” on page 8-1](#)
- [“Static Electricity and Other Precautions” on page 8-2](#)
- [“Disk Drive and Air Management Sled FRUs” on page 8-3](#)
- [“Power and Fan Module FRUs” on page 8-7](#)
- [“Installing a JBOD Chassis FRU” on page 8-11](#)

Note – Be sure to follow [“Static Electricity and Other Precautions” on page 8-2](#) for all procedures.

8.1 Available FRUs

Most FRUs are hot-swappable, except for a few modules that are hot-serviceable. *Hot-serviceable* means that the module can be replaced while the array and hosts are powered up, but the connected hosts must be inactive.



Caution – Please follow the FRU procedures carefully to ensure successful FRU replacement.

The following table lists the FRUs that are currently available. For additional FRUs, consult your sales representative or the Sun web sites.

TABLE 8-1 List of Available FRUs for the Sun StorEdge 3120 SCSI Array

FRU Model Number	Description
F370-6195-xx	1U JBOD, LVD, Chassis + I/O board with SAF-TE
F370-6193-xx	AC power supply and fan module, 1U
F370-6192-xx	DC power supply and fan module, 1U
F370-5405-xx	Cable, LVD, 1-foot, jumper
F370-5528-xx	Cable, LVD, 1.5-foot, expansion
F540-6054-xx	Drive module, 36 GB LVD, 10K RPM
F540-6055-xx	Drive module, 36 GB LVD, 15K RPM
F540-6056-xx	Drive module, 73 GB LVD, 10K RPM
F540-6057-xx	Drive module, 73 GB LVD, 15K RPM
F540-6058-xx	Drive module, 146 GB LVD, 10K RPM
XTA-3000-1URK-19U	Kit, rackmount, 1U, 19-in. wide, 18- to 28-in. deep
XTA-3000-1URK-19F	Kit, Telco rackmount center mount, 1U, 19-in. wide
XTA-3000-1URK-19C	Kit, Telco rackmount flush mount, 1U, 19-in. wide
XTA-3000-AMBS	Air management blank sled



Caution – You can mix capacity in the same chassis, but not spindle speed (RPMs) on the same SCSI bus. For instance, you can use 36 Gbyte and 73 Gbyte drives with no performance problems if both are 10K RPM drives. Violating this configuration guideline leads to poor performance.

8.2 Static Electricity and Other Precautions

Follow these steps to prevent damaging the FRUs:

- Remove plastic, vinyl, and foam from the work area.
- Before handling a FRU, discharge any static electricity by touching a ground surface.
- Wear an antistatic wrist strip.
- Do not remove a FRU from its antistatic protective bag until you are ready to install it.

- When removing a FRU from the array, immediately place it in an antistatic bag and in antistatic packaging.
- Handle a FRU only by its edges, and avoid touching the circuitry.
- Do not slide a FRU over any surface.
- Limit body movement (which builds up static electricity) during FRU installation.



Caution – To prevent any possibility of data loss, it is strongly recommended that you back up the data prior to removing disk drives.



Caution – Do not remove a defective module unless you have a replacement FRU module to immediately replace the defective module. If you remove a module and do not replace it, you alter the air flow inside the chassis and could overheat the chassis as a result.

8.3 Disk Drive and Air Management Sled FRUs

This section provides instructions for removing and installing disk drive, air management sled, and tabletop cover FRUs, and covers the following topics:

- [“Replacing a Disk Drive” on page 8-4](#)
- [“Identifying the Defective Disk Drive” on page 8-4](#)
- [“Removing a Defective Disk Drive” on page 8-5](#)
- [“Installing a New Disk Drive” on page 8-6](#)
- [“Installing an Air Management Sled” on page 8-7](#)

8.3.1 Replacing a Disk Drive

To replace a disk drive, you first remove the defective disk drive and then install a replacement drive. The drive module is hot-swappable; it is replaced while the array is powered on.



Caution – You can mix capacity in the same chassis, but not spindle speed (RPMs) on the same SCSI bus. For instance, you can use 36 Gbyte and 73 Gbyte drives with no performance problems if both are 10K RPM drives. Violating this configuration guideline leads to poor performance.

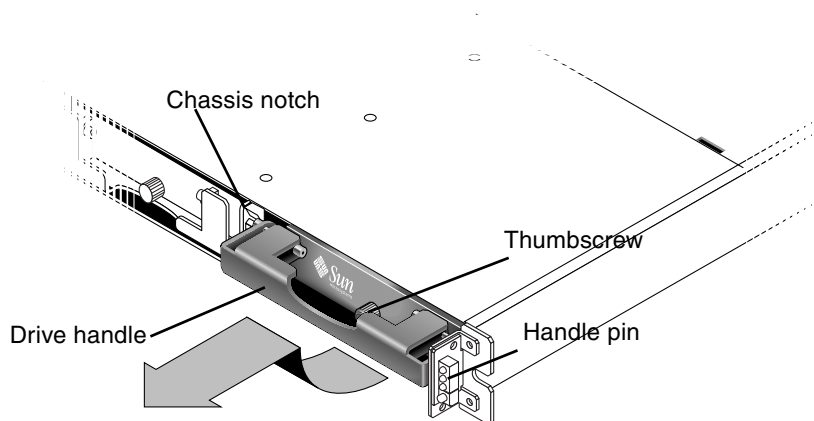

FIGURE 8-1 The Front View of a Drive Module Pulled Out of the Chassis

8.3.1.1 Identifying the Defective Disk Drive

To receive automatic email notification of a disk drive failure, set up Sun StorEdge Configuration Service or Sun StorEdge Diagnostic Reporter. For details, refer to the *Sun StorEdge 3000 Family Diagnostic Reporter User's Guide* or the *Sun StorEdge 3000 Family Configuration Service User's Guide*.

Before replacing a disk drive, perform the following steps to ensure that you have identified the correct defective disk for removal.



Caution – To prevent any possibility of data loss, it is strongly recommended that you back up the data prior to removing disk drives.

1. Examine the back of the array, and record the cable connections.

2. Physically locate the defective disk drive.

An amber LED next to a drive on the front panel of the JBOD indicates a failed disk drive. For details, see [“Front-Panel LEDs” on page 6-2](#).



Caution – Failure to identify the correct disk drive may result in replacing the wrong disk drive and could cause a loss of data. Be sure that you have identified the correct disk drive. It is strongly recommended that you back up the data prior to removing disks.

3. Record the Chl and ID number for the defective disk drive (for example, Chl 0 ID 4).

For descriptions of ID settings, see [“Fixed Drive IDs” on page 4-10](#).

4. (Optional.) In Sun StorEdge Configuration Service, a red icon in the main window indicates a JBOD drive failure. Review the error log to confirm the disk drive ID for the failed drive.

For details on the Sun StorEdge Configuration Service main window, see [“Main Window” on page 5-4](#).

5. (Optional.) In Sun StorEdge CLI, run the `show enclosure-status` command. If the drive status is “Absent” the drive may have failed, or has been removed from the chassis.

For details on the `show enclosure-status` command, see [“show enclosure-status” on page 5-12](#).

8.3.1.2

Removing a Defective Disk Drive



Caution – Failure to identify the correct disk drive may result in replacing the wrong disk drive and could cause a loss of data. Be sure that you have identified the correct disk drive. An amber drive LED indicates a drive failure. For details, see [“Front-Panel LEDs” on page 6-2](#).



Caution – To prevent any possibility of data loss, it is strongly recommended that you back up the data prior to removing disk drives.



Caution – Do not remove a defective module unless you have a replacement FRU module to immediately replace the defective module. If you remove a module and do not replace it, you alter the air flow inside the chassis and could overheat the chassis as a result.

Note – A newly installed disk drive automatically rebuilds with the correct parity, data and association with logical drive if a functioning global or spare drive has remained in the chassis. Therefore, do not remove and replace all drives at one time. If more than one drive fails in a logical drive (except RAID 1+0), then the logical drive fails, data is lost, and the logical drive must be rebuilt.

Remove the defective disk drive with the following steps.

1. **Unlock the locks with the provided key, and gently pull the plastic front bezel away from the front of the unit so that it drops down and is supported by the two hinged brackets on the sides.**
2. **Turn the thumbscrew counterclockwise several full turns until the thumbscrew and drive module are loosened.**
3. **Gently pull the release handle upward.**
4. **Pull the drive module out until the drive connector has fully disconnected from the midplane.**
5. **Wait 20 seconds for the drive to stop spinning and then remove it from the chassis.**

8.3.1.3 Installing a New Disk Drive



Caution – You can mix capacity in the same chassis, but not spindle speed (RPMs) on the same SCSI bus. For instance, you can use 36 Gbyte and 73 Gbyte drives with no performance problems if both are 10K RPM drives. Violating this configuration guideline leads to poor performance.

To install the replacement disk drive, perform the following steps.

1. **Gently slide the drive module into the drive slot until the handle pins slip into the chassis notch.**
2. **Lower the disk drive handle until it is vertical.**
3. **Press and hold the drive handle in while you press the thumbscrew in until it engages the threads.**
4. **Turn the thumbscrew clockwise until it is finger-tight.**
5. **Push the plastic front bezel onto the front of the unit until it is seated firmly, and use the key to lock the locks.**

A green drive LED indicates a functional drive. For details, see [“Front-Panel LEDs” on page 6-2](#).

6. If the replaced drive is in a JBOD directly attached to a server, perform any operations your host software requires to discover the new drive and bring it under software control.

For specific operating system instructions, see [“JBOD Disks Not Visible to the Host” on page 7-6](#).

7. (Optional.) If you are using Sun StorEdge Configuration Service, you can discover the new drives using the software.

For instructions, refer to the *Sun StorEdge 3000 Family Configuration Service User’s Guide*.

8.3.2 Installing an Air Management Sled

An air management sled looks identical to the disk drive module; however, it is an empty box and is used to maintain optimum airflow in a chassis.

If you have removed a disk drive and do not replace it, you can insert an air management sled to maintain the optimum airflow inside the chassis. You can install the air management sled by using the same procedure as [“Installing a New Disk Drive” on page 8-6](#).

8.4 Power and Fan Module FRUs

Topics covered in this section are:

- [“Replacing an AC Power Supply/Fan Module” on page 8-8](#)
 - [“Removing an AC Power Supply/Fan Module” on page 8-8](#)
 - [“Installing an AC Power Supply/Fan Module” on page 8-8](#)
- [“Replacing a DC Power Supply/Fan Module” on page 8-9](#)
 - [“Removing a DC Power Supply/Fan Module” on page 8-9](#)
 - [“Installing an DC Power Supply/Fan Module” on page 8-10](#)

The following power specifications apply to the power supply and fan modules:

TABLE 8-2 Power Specifications

AC power:	Voltage and frequency 90 to 264 VAC, 47 to 63 Hz
Input current:	4A max
Power-supply output voltages:	+5VDC and +12 VDC
DC power:	-48V DC (-36 VDC to -72 VDC)

8.4.1 Replacing an AC Power Supply/Fan Module



Caution – To avoid damage to equipment, do not remove a power supply/fan module without a working replacement.

8.4.1.1 Removing an AC Power Supply/Fan Module

1. Be sure to follow [“Static Electricity and Other Precautions”](#) on page 8-2.
2. Turn off the power, and then remove the AC cord locks (if applicable) and the power cable.
3. Turn the thumbscrew at the top of the power supply latch counterclockwise until the thumbscrew is disengaged from the power supply.

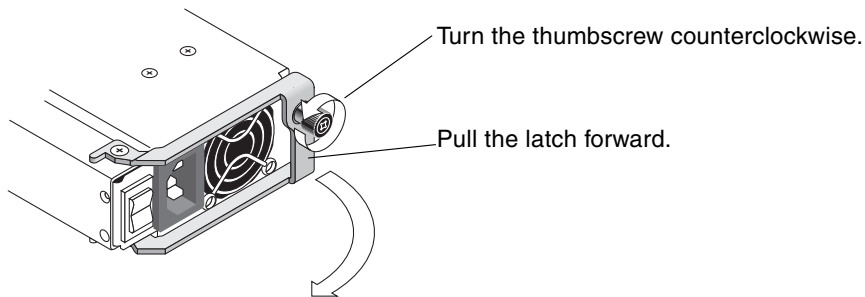

FIGURE 8-2 The Power Supply Partially Pulled out of the Chassis

4. Pull the latch forward about 90 degrees to disconnect the power supply/fan module from the midplane.
5. Pull the power supply/fan module out of the chassis.

8.4.1.2 Installing an AC Power Supply/Fan Module

1. Slide the new module into the fan and power supply slot.
2. Push the latch back so that the power supply is fully inserted into the chassis.
3. Turn the thumbscrew at the top of the power supply latch clockwise until it is finger-tight, to secure the module.

Note – To ensure that a thumbscrew is finger-tight, tighten it with a screwdriver and then loosen the thumbscrew counterclockwise a quarter-turn.

4. Attach the power cable and reinstall the AC cord locks if applicable.
5. Turn the power back on.

8.4.2 Replacing a DC Power Supply/Fan Module



Caution – To avoid damage to equipment, do not remove a power supply/fan module without a working replacement.

8.4.2.1 Removing a DC Power Supply/Fan Module

1. Be sure to follow [“Static Electricity and Other Precautions”](#) on page 8-2.
2. Turn off the power and remove the power cable.
3. Turn the thumbscrew at the top of the power supply latch counterclockwise until the thumbscrew is disengaged from the power supply.

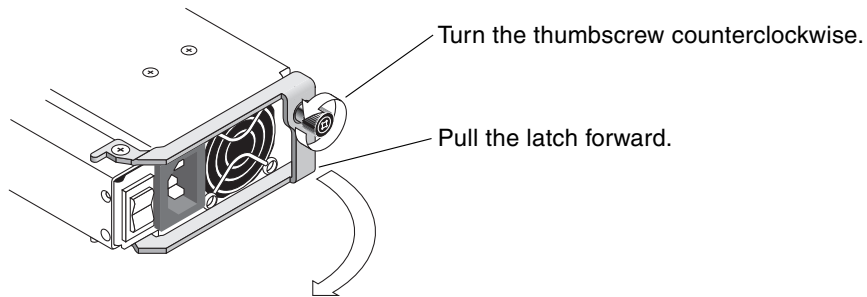

FIGURE 8-3 The Power Supply Partially Pulled out of the Chassis

4. Pull the latch forward about 90 degrees to disconnect the power supply/fan module from the midplane.
5. Pull the power supply/fan module out of the chassis.

8.4.2.2 Installing an DC Power Supply/Fan Module

1. Slide the new module into the fan and power supply slot.
2. Push the latch back so that the power supply is fully inserted into the chassis.
3. Turn the thumbscrew at the top of the power supply latch clockwise until it is finger-tight, to secure the module.

Note – To ensure that a thumbscrew is finger-tight, tighten it with a screwdriver and then loosen the thumbscrew counterclockwise a quarter-turn.

4. Connect the DC power cable to the DC source.

Note – Use only DC power cables provided with the array.

Check the DC cable part number and wire labels carefully before connecting the cable to the source (see the table below). GND = Chassis Ground.

TABLE 8-3 DC Cable Wiring

Cable 35-00000148			Cable 35-00000156		
Pin #	Voltage	Color	Pin #	Voltage	Color
A3	Return	Red	A3	L+	White
A2	GND	Green/yellow	A2	GND	Green/yellow
A1	-48V	Black	A1	L-	White

5. To extend the length of the DC power cable as needed: Strip the last 1/4-inch of the cable, insert it into a provided Panduit tube, and crimp the tube.
6. Attach the power cable to the array.
7. Turn the power on.

8.5 Installing a JBOD Chassis FRU

The Sun StorEdge 3120 SCSI array box FRU includes a chassis, its drive midplane, and its backplane. This product is ordered to replace a box that has been damaged or whose midplane, backplane, or terminator module has been damaged.

To make a fully functional array, you need to add the following parts from the replaced array:

- Drive modules
- Two power supply/fan modules

To install the individual modules, use the replacement instructions provided in this guide.

To configure the array, see [“Connecting Your SCSI Array” on page 4-1](#).

To replace the chassis frame of an existing JBOD, perform the following steps.



Caution – Connected hosts must be inactive during this replacement procedure.

Note – Be sure to follow [“Static Electricity and Other Precautions” on page 8-2](#) for all procedures.

1. Power off both power supply modules on the defective array.
2. Ensure all SCSI cables attached to the I/O module are labeled clearly.
3. Write down the defective array's cabling configuration.
4. Write down the SCSI ID switch setting, right or left.

The IDs assigned for disks 1 through 4 depend on the switch settings on the array. The right switch setting uses IDs 8, 9, 10, and 11. The left switch setting uses IDs 12, 13, 14, and 15.

5. Remove all SCSI cables attached to the I/O module.
6. Label each disk drive with its disk slot position in the array.
7. Remove the power supply modules and disk drives from the defective array.
8. Remove the defective chassis.
9. Obtain the replacement chassis.

10. Re-install all previously removed modules in their original positions into the replacement array.
11. Re-install all SCSI and power cables in their original positions.
12. Set the SCSI ID switch to right or left depending on your previous configuration.

Note – SCSI IDs are set based on the switch setting on the array when it is powered on. If you change the switch setting, the SCSI IDs will change after you power off, and then power on.

13. Power on both power supply modules on the replacement array.
14. See [“Connecting Your SCSI Array” on page 4-1](#) for instructions about configuring the JBOD.

SCSI Array Specifications

This appendix provides the specifications for the Sun StorEdge 3120 SCSI array. The topics covered are:

- [“Summary of Physical Specifications” on page A-2](#)
- [“Summary of Sun StorEdge 3120 SCSI Array Specifications” on page A-3](#)
- [“Agency Approvals and Standards” on page A-4](#)
- [“SCSI Host or Drive Connector” on page A-6](#)
- [“SCSI Host or Drive Cable” on page A-7](#)

A.1 Summary of Physical Specifications

TABLE A-1 Sun StorEdge 3120 SCSI Array Physical Specifications

Feature	Description
Height	1U (1.75 inch / 4.445 cm.)
Width	19 inch / 48.26 cm. (body)
Depth	Main chassis 18 inch/ 45.72 cm. To back of power supply: 20 inch/ 50.8 cm. To back of power supply handle: 21 inch / 53.34 cm.
Weight (JBOD)	30 lbs. / 13.608 kg. with 146 GB drives
General	<ul style="list-style-type: none">• 4 hot-pluggable drives in a 1U (1.75 inch high) chassis• Ultra 320 SCSI buses• Autosensing AC or DC power supplies
Density	<ul style="list-style-type: none">• Up to 584GB in a SCSI array• 21-inch chassis depth
Reliability	<ul style="list-style-type: none">• Redundant hot swappable FRUs• N+1 hot swappable power and cooling• NEBS Level 3 and HALT test certified; Designed to meet 99.999% reliability

Note – Add 10.6 lbs. (4.8 kg.) for packaging if you want to know the shipping weight of your array.

A.2 Summary of Sun StorEdge 3120 SCSI Array Specifications

Feature	Description
General	<ul style="list-style-type: none">• 4 hot-pluggable drives in a 1U (1.75 inch high) chassis• Ultra 320 SCSI buses• Autosensing AC or DC power supplies
Density	<ul style="list-style-type: none">• Up to 584GB in a RAID array• 21-inch chassis depth
Reliability	<ul style="list-style-type: none">• Redundant hot swappable FRUs• N+1 hot swappable power and cooling• NEBS Level 3 and HALT test certified; Designed to meet 99.999% reliability
Array System Storage Resource Management	<ul style="list-style-type: none">• Four Ultra320 SCSI channels• Support for Sun StorEdge Configuration Service and Sun StorEdge Diagnostic Reporter management software and the Sun StorEdge Command-Line Interface (CLI) utility

A.3 Agency Approvals and Standards

Product Safety

Country	Standard
U.S.	UL Listed to UL60950:2000, 3rd Edition
Canada	CSA Standard CAN/CSA-C22.2 No. 60950-00 3rd Edition
Germany	TÜV
European Union	EN60950:2000
Japan	Part of World-wide CB Scheme
Australia	Part of World-wide CB Scheme
Argentina	Resolution 92-98 (S-Mark)
Germany	GS mark (ergonomics) (Rheinland)
Russia	Part of World-wide CB Scheme (GOST-R mark)
Russia	Hygienic Mark-(ergonomics)

Electromagnetic Compatibility

Country	Standard
U.S.	FCC #47, Part 15, Subpart B, Class B
Canada	ICES-003
Japan	VCCI Class B
European Union	EN 55022:1998 Class B
Australia/New Zealand	AS/NZS 3548:1996
Taiwan	BSMI CNS 13438 Class B
Russia	GOST-R mark
Germany	Same as European Union
Argentina	S mark

Electromagnetic Interference

Test	Standard
Harmonics Emissions	EN 61000-3-2:2000 (No Limits)
Voltage Flicker	EN 61000-3-3:1995/A1:2001 (No Limits)
ESD	EN 55024 (8kV Contact, 15kV Air)

RF Field	EN 55024 (10V/m)
Electrical Fast Transient Burst	EN 55024 (1kV I/O, 2kV Power)
Surge	EN 55024 (1kV I/O, 1kV Power L-L, 2kV Power L-G)
RF Conducted	EN 55024 (3V I/O and Power)
Power Frequency Magnetic Field	EN 55024 (N/A monitors only)
Voltage Dip and Interruption	EN 55024 (0V/0.5cycle, 70%V/0.5sec, 0V/5sec)

A.4 SCSI Host or Drive Connector



FIGURE A-1 SCSI Host or Drive Connector

TABLE A-2 SCSI Connector Pin Descriptions

Pin	Description	Pin	Description
1	Data 12 +	35	Data 12 -
2	Data 13 +	36	Data 13 -
3	Data 14 +	37	Data 14 -
4	Data 15 +	38	Data 15 -
5	Parity 1 +	39	Parity 1 -
6	Data 0 +	40	Data 0 -
7	Data 1 +	41	Data 1 -
8	Data 2 +	42	Data 2 -
9	Data 3 +	43	Data 3 -
10	Data 4 +	44	Data 4 -
11	Data 5 +	45	Data 5 -
12	Data 6 +	46	Data 6 -
13	Data 7 +	47	Data 7 -
14	Parity 0 +	48	Parity 0 -
15	Ground	49	Ground
16	DIFF_SENS	50	Ground
17	TERM_PWR	51	TERM_PWR
18	TERM_PWR	52	TERM_PWR
19	N/C	53	N/C
20	Ground	54	Ground

TABLE A-2 SCSI Connector Pin Descriptions *(Continued)*

Pin	Description	Pin	Description
21	ATN +	55	ATN -
22	Ground	56	Ground
23	BSY +	57	BSY -
24	ACK +	58	ACK -
25	RST +	59	RST -
26	MSG +	60	MSG -
27	SEL +	61	SEL -
28	C/D +	62	C/D -
29	REQ +	63	REQ -
30	I/O +	64	I/O -
31	Data 8 +	65	Data 8 -
32	Data 9 +	66	Data 9 -
33	Data 10 +	67	Data 10 -
34	Data 11 +	68	Data 11 -

A.5 SCSI Host or Drive Cable

Standard .8mm 68-pin LVD SCSI cable:

**FIGURE A-2** Cross-section of the 68-Conductor SCSI Pinout for LVD/MSE SCSI

TABLE A-3 SCSI Connector Pin Numbers and Cable Pairs

PIN#	CABLE PAIR	SE/LVD	PIN#	CABLE PAIR	SE/LVD
1	30SR/+DB12		35	30-DB12/-DB12	
2	31SR/+DB13		36	31-DB13/-DB13	
3	32SR/+DB14		37	32-DB14/-DB14	
4	33SR/+DB15		38	33-DB15/-DB15	
5	34SR/+DBP1		39	34-DBP1/-DBP1	
6	16SR/+DB0		40	16-DB0/-DB0	
7	17SR/+DB1		41	17-DB1/-DB1	
8	18SR/+DB2		42	18-DB2/-DB2	
9	19SR/+DB3		43	19-DB3/-DB3	
10	20SR/+DB4		44	20-DB4/-DB4	
11	21SR/+DB5		45	21-DB5/-DB5	
12	22SR/+DB6		46	22-DB6/-DB6	
13	23SR/+DB7		47	23-DB7/-DB7	
14	24SR/+P_CRCA		48	24-DBP/-P_CRCA	
15	25GND/GND		49	25GND/GND	
16	15DIFFSENSE		50	15GND/GND	
17	14TPWR/TPWR		51	14TPWR/TPWR	
18	13TPWR/TPWR		52	13TPWR/TPWR	
19	12RSVD/RSVD		53	12RSVD/RSVD	
20	5GND/GND		54	5GND/GND	
21	6SR/+ATN		55	6-ATN/-ATN	
22	7GND/GND		56	7GND/GND	
23	4SR/+BSY		57	4-BSY/-BSY	
24	3SR/+ACK		58	3-ACK/-ACK	
25	8SR/+RST		59	8-RST/-RST	
26	9SR/+MSG		60	9-MSG/-MSG	
27	10SR/+SEL		61	10-SEL/-SEL	
28	2SR/+C/D		62	2-C/D/-C/D	
29	1SR/+REQ		63	1-REQ/-REQ	
30	11SR/+I/O		64	11-I/O/-I/O	
31	26SR/+DB8		65	26-DB8/-DB8	
32	27SR/+DB9		66	27-DB9/-DB9	
33	28SR/+DB10		67	28-DB10/-DB10	
34	29SR/+DB11		68	29-DB11/-DB11	

*SR=Signal Return, *RSVD=Reserved, *GND=Ground, *TPWR=TERMPWR

Index

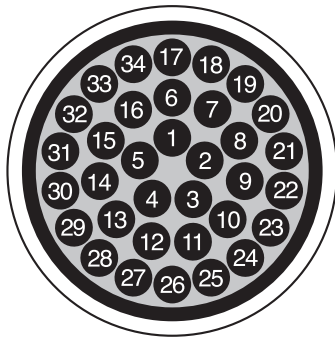
A

- about command, 5-7
- AC power supply/fan module
 - connecting, 4-4
 - installing, 8-8
 - removing, 8-8
- Agent Options Management window, 5-2
- air management sled, installing, 8-7
- alarms
 - LED indicators, 6-3, 6-5
 - silencing, 6-2, 7-3
 - viewing with SSCS, 5-4, 7-3
- application servers, 1-3
- array configurations, 1-2

B

- beep codes, muting, 6-2
- best practices, 1-2
- bezel locks, 4-2
- bus cable lengths, 4-7
- bus configurations, 4-9

C

- cables
 - standard package, 3-3
- cabling
 - cables supplied, 3-2
 - customer-provided, 3-3

- JBODs, 4-8
 - lengths, 4-7
 - procedures, 4-1
 - single vs split-bus configurations, 4-9
 - single-bus configurations, 4-9, 4-11
 - single-bus drive IDs, 4-11
 - summary, 4-1
- cautions, general, 8-2
- chassis
 - FRU, installing, 8-11
 - status, 5-12
- checking adapter BIOS, 7-14, 7-17
- clearances to allow, 2-5
- CLI. See Sun StorEdge CLI.
- components
 - viewing status with CLI, 5-12
 - viewing status with SSCS, 5-4
- configuring arrays, 1-2
- connecting arrays to hosts, 4-8
- customer obligations, 2-2

D

- DC power supply/fan module
 - connecting, 4-6
 - installing, 8-10
 - removing, 8-9
- decision trees for troubleshooting, 7-19
- default JBOD settings, 4-10
- device status
 - icons, 5-5

- viewing with SSCS, 5-4
- disk drives
 - identifying defective drives, 8-4
 - installing new drives, 8-6
 - removing, 8-5
 - replacing, 8-4
 - status, 5-12
- downloading firmware, 7-2
- dual-bus configuration. See split-bus configuration.

E

- electrical specifications, 2-4
- electromagnetic compatibility (EMC), 2-4
- environmental range, 2-3
- event LED, 6-3
- event logs
 - HP-UX, 7-5
 - IBM AIX, 7-5
 - Linux, 7-5
 - Solaris, 7-5
 - Windows, 7-5
- exit command, 5-7

F

- fan
 - FRU, 8-8, 8-10
 - LED, 6-3, 6-5
 - status, 5-12
- file servers, 1-3
- firmware
 - upgrading, 7-2
- FRUs
 - listing of, 8-2
 - viewing with CLI, 5-13, 5-15

G

- gray device status item, 5-5

H

- hardware
 - overview, 1-1
 - specifications, A-3
 - troubleshooting, 7-4
- HBA devices, 4-14, 4-18
- help command, 5-8
- HP-UX operating system, 7-15
- humidity, 2-3

I

- IBM AIX operating system, 7-5, 7-15
- icon status in SSCS, 5-5
- IDs, setting, 4-10
- installing firmware patches, 7-2

J

- JBOD
 - cabling, 4-8
 - default drive settings, 4-10
 - multi-initiator configuration, 4-14, 4-18
 - single-bus configuration, 4-12, 4-14, 5-2
 - single-initiator configuration, 4-15
 - split-bus configuration, 4-9, 4-15, 5-3
 - switch settings, 4-10

K

- keys, removing from bezel locks, 4-2

L

- LEDs
 - back panel, 6-4
 - blinking, 6-5
 - drives, 6-2
 - front panel, 6-3
 - illuminating with CLI, 5-9
 - status of, 5-15
- left switch setting, 4-10
- Linux operating system, 7-14

M

- maintaining the array, 7-1
- Microsoft Windows operating system, 7-7, 7-10
- multi-initiator JBOD configuration, 4-14, 4-18
- multi-path software, 4-14, 4-18, 5-17
- muting alarms, 6-2

P

- package contents, 3-2
- performance problems, 7-17, 8-2, 8-4, 8-6
- physical specifications, A-2
- pinout for LVD/MSE SCSI, A-7
- planning site, 2-1
- ports
 - connecting (see cabling), 4-1
 - names, 4-11
- power LED, 6-3
- power specifications, 2-4
- power supply
 - AC, 8-8
 - DC, 8-10
 - LED, 6-5
 - status, 5-12
- print servers, 1-3
- purple device status icon
 - device status state, 5-5

Q

- quit command, 5-8

R

- red device status item, 5-5
- removing keys from bezel locks, 4-2
- replacing failed drives
 - HP-UX, 7-15
 - Linux, 7-14
 - Microsoft Windows, 7-7
 - Solaris, 7-7
 - Windows, 7-10
- requirements

- application servers, 1-3
- file servers, 1-3
- print servers, 1-3
- reset button, 7-3
- resetting alarms, 6-2
- right switch setting, 4-10

S

- safety precautions, 2-2
- SAF-TE
 - IDs, 4-10
 - status, 5-12, 5-16
- SB icon, 4-9
- SCSI connector, A-7
- SCSI IDs, 4-8, 4-10, 5-17
- select command, 5-8
- set led command, 5-9
- setting unique HBA device IDs, 5-17
- show configuration command, 5-10
- show enclosure-status command, 5-12
- show frus command, 5-13
- show inquiry-data command, 5-15
- show led-status command, 5-15
- silencing alarms, 6-2, 7-3
- single processor servers, 1-3
- single-bus configurations
 - cabling, 4-9, 4-11
 - drive IDs, 4-11
 - label, 4-9
 - setting unique HBA IDs for, 5-17
 - viewing in SSCS, 5-3
- single-initiator JBOD configuration, 4-15
- site planning
 - customer obligations, 2-2
 - electrical/power, 2-4
 - EMC, 2-4
 - environmental, 2-3
 - layout, 2-6
 - overview, 2-1
 - physical, 2-5
 - safety precautions, 2-2
- site preparation survey, 2-6
- software management tools, 1-8
- Solaris operating system, 7-6, 7-7

- specifications
 - clearances, 2-5
 - electrical/power, 2-4
 - physical (array), 2-5
 - product, A-3
- split-bus configurations
 - cabling, 4-9
 - limitations, 5-3, 5-12
 - multi-initiator, 4-18
 - single-initiator, 4-15
 - viewing in SSCS, 5-3
- SSCS. See Sun StorEdge Configuration Service.
- static electricity precautions, 8-2
- storage requirements, 1-3
- Sun cluster, 4-14, 4-18
- Sun Fire V120, 1-3
- Sun StorEdge CLI
 - about command, 5-7
 - exit command, 5-7
 - help command, 5-8
 - overview, 5-7
 - quit command, 5-8
 - set led command, 5-9
 - show configuration command, 5-10
 - show enclosure-status command, 5-12
 - show frus command, 5-13, 5-15
 - show inquiry-data command, 5-15
 - show led-status command, 5-15
 - version command, 5-17
 - viewing status with, 5-4
- Sun StorEdge Configuration Service
 - component characteristics, 5-4
 - enabling JBOD support, 5-2
 - main window, 5-4
 - overview, 5-2
 - single-bus configurations, 5-3
 - split-bus configurations, 5-3
 - viewing alarms with, 5-4
- switch settings, 4-8, 4-10

T

- temp LED, 6-3
- temperature
 - environmental range, 2-3
 - status, 5-12

- temperature LED, 6-3
- troubleshooting, 7-1

U

- Ultra320 cable, 4-7
- unique IDs, setting, 4-10, 5-17
- upgrading firmware, 7-2

V

- Veritas cluster, 4-14, 4-18
- Veritas software, 5-17
- version command, 5-17
- View and Enclosure window, 5-4

W

- white device status item, 5-5
- Windows servers
 - new devices and LUNs, 7-10
- writing events to log files, 7-5

Y

- yellow device status item, 5-5