



@server

xSeries 345
Type 8670

Hardware Maintenance Manual and Troubleshooting
Guide





@server

xSeries 345

Type 8670

Hardware Maintenance Manual and Troubleshooting
Guide

Note

Before using this information and the product it supports, read Appendix C, "Notices," on page 159.

Eighth Edition (December 2003)

The most recent version of this document is available on the World Wide Web at <http://www.ibm.com/pc/support>.

© Copyright International Business Machines Corporation 2003. All rights reserved.

US Government Users Restricted Rights – Use, duplication or disclosure restricted by GSA ADP Schedule Contract with IBM Corp.

About this manual

This manual contains diagnostic information, a Symptom-to-FRU index, service information, error codes, error messages, and configuration information for the IBM® @server xSeries® 345.

Important: The field replaceable unit (FRU) procedures are intended for trained servicers who are familiar with IBM xSeries products. See the parts listing in “System” on page 114 to determine if the component being replaced is a customer replaceable unit (CRU) or a field replaceable unit (FRU).

Important safety information

Be sure to read all caution and danger statements in this book before performing any of the instructions. See “Safety information” on page 121.

Leia todas as instruções de cuidado e perigo antes de executar qualquer operação.

在安装本产品之前，请仔细阅读 **Safety Information** (安全信息)。

安裝本產品之前，請先閱讀「安全資訊」。

Prenez connaissance de toutes les consignes de type Attention et Danger avant de procéder aux opérations décrites par les instructions.

Lesen Sie alle Sicherheitshinweise, bevor Sie eine Anweisung ausführen.

Accertarsi di leggere tutti gli avvisi di attenzione e di pericolo prima di effettuare qualsiasi operazione.

製品の設置の前に、安全情報をお読みください。

본 제품을 설치하기 전에 안전 정보를 읽으십시오.

Lea atentamente todas las declaraciones de precaución y peligro ante de llevar a cabo cualquier operación.

WARNING: Handling the cord on this product or cords associated with accessories sold with this product, will expose you to lead, a chemical known to the State of California to cause cancer, and birth defects or other reproductive harm. ***Wash hands after handling.***

ADVERTENCIA: El contacto con el cable de este producto o con cables de accesorios que se venden junto con este producto, pueden exponerle al plomo, un elemento químico que en el estado de California de los Estados Unidos está considerado como un causante de cancer y de defectos congénitos, además de otros riesgos reproductivos. ***Lávese las manos después de usar el producto.***

Online support

You can download the most current diagnostic, BIOS flash, and device driver files from <http://www.ibm.com/pc/support> on the World Wide Web.

Contents

About this manual	iii
Important safety information	iii
Online support	iii
Chapter 1. General information.	1
Related publications	1
Notices and statements in this book	2
Features and specifications	3
Server controls and indicators	4
Front view	4
Rear view	5
Server power features	6
Turning on the server	6
Turning off the server	6
Standby mode	7
Chapter 2. Configuring your server	9
Using the ServerGuide Setup and Installation CD	9
System partition	10
Typical NOS installation	10
Setting up or updating multiple servers	11
Installing your NOS without ServerGuide	11
Using the Configuration/Setup Utility program	11
Starting the Configuration/Setup Utility program	11
Using passwords	12
Using ServeRAID Manager	13
Configuring the controller	14
Viewing your configuration	17
Getting assistance	19
Using the LSI Logic Configuration Utility program	20
Updating the integrated system-management firmware	21
Configuring the Ethernet controller	21
Teaming mode	22
Priority packet mode	22
Virtual LAN mode	24
Chapter 3. Diagnostics	25
General checkout	25
Diagnostic tools overview	26
POST error logs	27
Viewing error logs from the Configuration/Setup Utility program	27
Viewing error logs from diagnostic programs	28
ServerGuide error symptoms	28
Small computer system interface messages	28
Diagnostic programs and error messages	28
Text messages	29
Starting the diagnostic programs	30
Diagnostic error message tables	31
Identifying problems using status LEDs	31
Power supply LEDs	31
Light Path Diagnostics	32
Recovering the BIOS code	36
Power checkout	37

Troubleshooting the Ethernet controller	38
Network connection problems	38
Ethernet controller troubleshooting chart	39
Ethernet controller messages	40
Chapter 4. Customer replaceable units	41
Before you begin	41
System reliability considerations	41
Working inside the server with the power on	42
Handling static-sensitive devices	42
Major components of the xSeries 345 Type 8670 server.	43
Component locations.	44
System-board option connectors	44
PCI riser-card option connectors	44
System-board internal cable connectors.	45
System-board external port connectors	45
System-board switches and jumpers	46
System-board LED locations	47
Removing the cover and bezel	48
Working with adapters	48
Installing a ServeRAID-5i adapter	54
Installing a hot-swap drive	55
Installing memory modules	56
Installing a microprocessor	58
Installing a hot-swap power-supply	65
Replacing a hot-swap fan	67
Replacing the battery	68
Completing the installation.	70
Installing the server cover and bezel	70
Installing the server in a rack.	70
Updating your server configuration.	70
Connecting external options	71
Cabling the server.	72
Input/output ports	72
Video port.	73
Keyboard port	73
Auxiliary-device (pointing device) port	73
Ultra320 SCSI controller system-board connectors	74
Serial port.	75
Universal Serial Bus version 1.1 ports	75
Ethernet ports	76
Integrated system-management ports	76
Chapter 5. Field replaceable units	77
Hard disk drive backplane	77
Diagnostics/operator panel card.	78
Power-supply cage	79
System-board shuttle	80
Chapter 6. Symptom-to-FRU index	81
Beep symptoms	81
No-beep symptoms	84
Diagnostic panel system-error LED	84
Diagnostic error codes	86
Error symptoms	91
Power-supply LED errors	99

POST error codes	100
Service processor error codes	105
SCSI error codes	106
Temperature error messages	106
Fan error messages	107
Power error messages	107
System shutdown	108
Voltage related system shutdown.	108
Temperature related system shutdown	108
Hard disk drive checkout	109
Host built-in self test (BIST).	109
Bus fault messages.	109
Undetermined problems	110
Problem determination tips	111
Chapter 7. Parts listing xSeries 345 Type 8670	113
System	114
Keyboard CRUs	116
Power cords	117
Appendix A. Getting help and technical assistance	119
Before you call	119
Using the documentation	119
Getting help and information from the World Wide Web	119
Software service and support	120
Hardware service and support.	120
Appendix B. Related service information	121
Safety information	121
General safety	121
Electrical safety	122
Safety inspection guide	123
Handling electrostatic discharge-sensitive devices	124
Grounding requirements	124
Safety notices (multilingual translations)	124
Appendix C. Notices	159
Edition notice	159
Trademarks.	160
Important notes	160
Product recycling and disposal	161
Electronic emission notices	161
Federal Communications Commission (FCC) statement	161
Industry Canada Class A emission compliance statement	162
Australia and New Zealand Class A statement	162
United Kingdom telecommunications safety requirement	162
European Union EMC Directive conformance statement	162
Taiwanese Class A warning statement	163
Chinese Class A warning statement.	163
Japanese Voluntary Control Council for Interference (VCCI) statement	163

Chapter 1. General information

Your IBM @server xSeries 345 Type 8670 server is a high-performance server that can be upgraded to a symmetric multiprocessing (SMP) server through a microprocessor upgrade. It is ideally suited for networking environments that require superior microprocessor performance, efficient memory management, flexibility, and reliable data storage.

The xSeries 345 server contains several IBM X-Architecture™ technologies, which help increase server performance and reliability.

Your server comes with a limited warranty. If you have access to the World Wide Web, you can obtain up-to-date information about your server model and other IBM server products at <http://www.ibm.com/pc/us/eserver/xseries/>.

Your server serial number and model number are on labels on the bottom of the server and on the front below the bezel. You will need these numbers when you register your server with IBM. The information label with the serial number, machine type, model number, and agency marks for your server are on the bottom of the server.

Related publications

This *Hardware Maintenance Manual and Troubleshooting Guide* is provided in Portable Document Format (PDF) on the IBM *xSeries Documentation CD*. It contains information to help you solve the problem yourself or to provide helpful information to a service technician.

In addition to this *Hardware Maintenance Manual and Troubleshooting Guide*, the following xSeries 345 Type 8670 documentation is provided with your server:

- *Installation Guide*
This printed publication contains setup and installation instructions.
- *Rack Installation Instructions*
This printed publication contains the instructions to install your server in a rack.
- *Safety Book*
This multilingual publication is provided in PDF on the IBM *xSeries Documentation CD*. It contains translated versions of the caution and danger statements that appear in the documentation for your server. Each caution and danger statement has an assigned number, which you can use to locate the corresponding statement in your native language.
- *User's Guide*
This publication is provided in PDF on the IBM *xSeries Documentation CD*. It contains general information about your server, including information about features, how to configure your server, how to use the *ServerGuide™ Setup and Installation CD*, and how to get help.
- *Option Installation Guide*
This publication is provided in PDF on the IBM *xSeries Documentation CD*. It contains instructions to install, remove, and connect optional devices supported by your server.

Depending on your server model, additional publications might be included on the IBM *xSeries Documentation CD*.

Notices and statements in this book

The caution and danger statements used in this book also appear in the multilingual *Safety Information* book provided on the IBM *xSeries Documentation* CD. Each caution and danger statement is numbered for easy reference to the corresponding statements in the safety book.

The following types of notices and statements are used in this book:

- **Note:** These notices provide important tips, guidance, or advice.
- **Important:** These notices provide information or advice that might help you avoid inconvenient or problem situations.
- **Attention:** These notices indicate possible damage to programs, devices, or data. An attention notice is placed just before the instruction or situation in which damage could occur.
- **Caution:** These statements indicate situations that can be potentially hazardous to you. A caution statement is placed just before the description of a potentially hazardous procedure step or situation.
- **Danger:** These statements indicate situations that can be potentially lethal or extremely hazardous to you. A danger statement is placed just before the description of a potentially lethal or extremely hazardous procedure step or situation.

Features and specifications

The following table provides a summary of the features and specifications for your server.

Table 1. Features and specifications

<p>Microprocessor:</p> <ul style="list-style-type: none"> Intel™ Xeon, 3.067 GHz or higher depending on server model 533 MHz front-side bus (FSB) Support for up to two microprocessors with Intel Hyper-Threading technology <p>Memory:</p> <ul style="list-style-type: none"> Minimum: 512 MB, expandable to 8 GB Type: 100 MHz, PC2100 (CL2.5), downward compatible with PC1600 (CL2), registered, ECC, double data rate (DDR), SDRAM Sizes: 256 MB, 512 MB, 1 GB or 2 GB, in pairs Connectors: Two-way interleaved, four dual inline memory module (DIMM) connectors Maximum: Two pairs of DIMMs <p>Drives standard:</p> <ul style="list-style-type: none"> Diskette: 1.44 MB CD-ROM: IDE <p>Expansion bays:</p> <ul style="list-style-type: none"> Six hot-swap, slim-high, 3.5-inch drive bays (hot-swap hard disk drives installed, some models) One 5.25-inch bay (CD-ROM drive installed) One 3.5-inch removable-media drive bay (diskette drive installed) <p>Hot-swap fans:</p> <ul style="list-style-type: none"> Minimum: Five Maximum: Eight - provide redundant cooling <p>Hot-swap power supplies:</p> <p>350 watts (115-230 V ac) or 514 watts (115-230 V ac) depending on server model</p> <ul style="list-style-type: none"> Minimum: One Maximum: Two - provide redundant power <p>Upgradeable microcode:</p> <p>BIOS, diagnostics, and IBM Advanced System Management upgrades (when available) can update EEPROM on the system board</p>	<p>PCI expansion slots:</p> <ul style="list-style-type: none"> Two PCI-X non-hot-plug 133 MHz/64-bit Two PCI-X non-hot-plug 100 MHz/64-bit (low profile) One PCI non-hot-plug, 33 MHz/32-bit <p>Integrated functions:</p> <ul style="list-style-type: none"> IBM integrated system management processor (ISMP) <ul style="list-style-type: none"> Service processor with Light Path Diagnostics Interconnect port Dedicated I/O port Support for IBM Remote Supervisor Adapter Two 10BASE-T/100BASE-TX/1000BASE-T Ethernet ports (Intel Ethernet controller on system board) One serial port One external and one internal Ultra320 SCSI port (dual-channel integrated controller with RAID capability) Three Universal Serial Bus (USB) v1.1 ports Keyboard port Mouse port ATI Rage XL video (controller on system board) <ul style="list-style-type: none"> Compatible with SVGA and VGA 8 MB video memory <p>Acoustical noise emissions:</p> <ul style="list-style-type: none"> Declared sound power, idle: 6.5 bel Declared sound power, operating: 6.5 bel Bystander sound pressure, idle: 48 dBA Bystander sound pressure, operating: 48 dBA <p>Environment:</p> <ul style="list-style-type: none"> Air temperature: <ul style="list-style-type: none"> Maximum altitude: 2133 m (7000 ft) Server on: 10° to 35°C (50° to 95°F) Server off: -40° to +60°C (-40° to 140°F) Humidity: <ul style="list-style-type: none"> Server on: 8% to 80% Server off: 8% to 80% 	<p>Security features:</p> <ul style="list-style-type: none"> Power-on password Remote-control security settings Selectable drive startup Keyboard password System management security <ul style="list-style-type: none"> User login password Read-only or read/write access Dial-in call-back <p>Predictive Failure Analysis® (PFA) alerts:</p> <ul style="list-style-type: none"> Power supplies Fans Memory Hard disk drives Microprocessors Voltage regulator modules (VRMs) <p>Size (2 U):</p> <ul style="list-style-type: none"> Height: 85.4 mm (3.36 in.) Depth: 698 mm (27.48 in.) Width: 443.6 mm (17.5 in.) Weight: 21.09 kg (46.5 lb) to 28.12 kg (62 lb) depending upon configuration <p>Heat output:</p> <p>Approximate heat output in British thermal units (Btu) per hour</p> <ul style="list-style-type: none"> Minimum configuration: 341 Btu/hour (100 watts) Maximum configuration: 2250 Btu/hour (660 watts) <p>Electrical input:</p> <ul style="list-style-type: none"> Sine-wave input (50-60 Hz) required Input voltage range automatically selected Input voltage low range: <ul style="list-style-type: none"> Minimum: 90 V ac Maximum: 137 V ac Input voltage high range: <ul style="list-style-type: none"> Minimum: 180 V ac Maximum: 265 V ac Input kilovolt-amperes (kVA) approximately: <ul style="list-style-type: none"> Minimum: 0.1 kVA Maximum: 0.7 kVA <p>Power available for drives:</p> <ul style="list-style-type: none"> +5 V dc +12 V dc
--	--	--

Server controls and indicators

This section identifies the controls and indicators on the front and the back of your server.

Note: The illustrations in this document might differ slightly from your hardware.

Front view

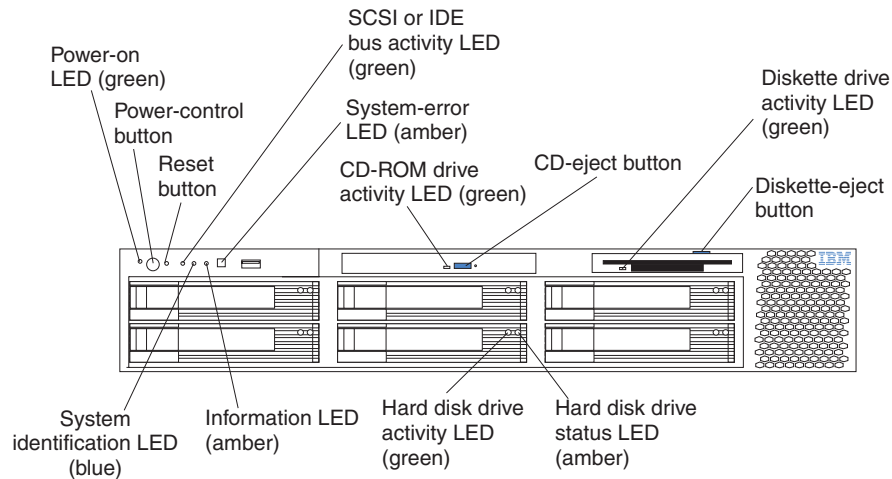

Power-on LED: This green light-emitting diode (LED) is lit and stays on when you turn on your server and flashes when the server is in Standby mode.

Attention: If the power-on LED is off, it does not mean there is no electrical current present in the server. The LED might be burned out. To remove all electrical current from the server, you must unplug the server power cords from the electrical outlets or from the uninterruptible power device.

Power-control button: Press this button to manually turn on the server and put the server in Standby mode (see “Server power features” on page 6).

Reset button: Press this button to reset the server and run the power-on self-test (POST). You might need to use a pen or the end of a straightened paper clip to press the button.

SCSI or IDE bus activity LED: This LED is on when there is activity on the SCSI or IDE bus.

System-error LED: This amber LED is lit when a system error occurs. An LED on the diagnostic LED panel will also be on to further isolate the error.

CD-ROM drive activity LED: When this LED is lit, it indicates that the CD-ROM drive is in use.

CD-eject button: Press this button to release a CD from the drive.

Diskette drive activity LED: When this LED is lit, it indicates that the diskette drive is in use.

Diskette-eject button: Press this button to release a diskette from the drive.

Hard disk drive activity LED: Each of the hot-swap drives has a hard disk drive activity LED. When this green LED is flashing, the controller is accessing the drive.

Hard disk drive status LED: Each hot-swap drive has a hard disk drive status LED. When this amber LED is lit continuously, the drive has failed. If a RAID adapter is installed in the server, when the LED flashes slowly (one flash per second), the drive is being rebuilt. When the LED flashes rapidly (three flashes per second), the controller is identifying the drive.

Information LED: This amber LED is lit when the information log contains information about certain conditions in your server that might affect performance. For more information, see “Diagnostic panel LEDs” on page 33.

System-identification LED: This blue LED is lit in response to a programmed condition, or it can be turned on remotely by the system administrator to aid in server identification for maintenance. The system administrator can turn off the system identification LED after maintenance is complete.

Rear view

This section identifies the indicators on the rear of your server.

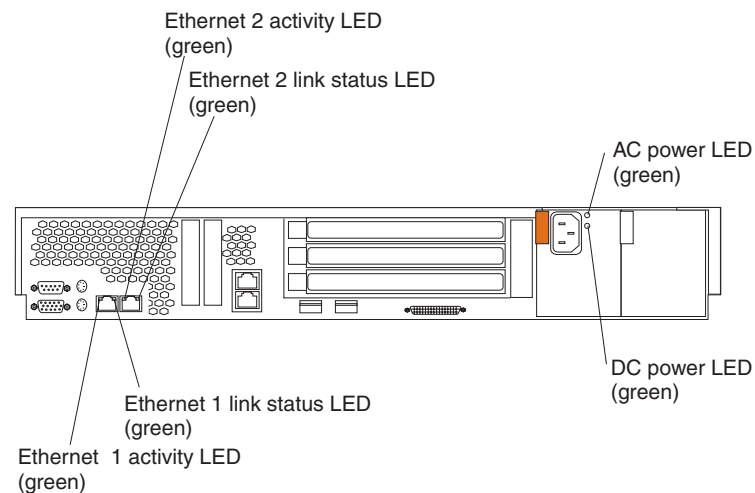

Ethernet 2 activity LED: This green LED is lit when the server is transmitting or receiving signals to the Ethernet LAN that is connected to Ethernet port 2.

Ethernet 2 link status LED: This green LED is lit when there is an active link connection on the 10BASE-T, 100BASE-TX, or 1000BASE-TX interface for Ethernet port 2.

AC power LED: This green LED provides status information about the power supply. During typical operation, both the ac and dc power LEDs are lit. For any other combination of LEDs, see “Power supply LEDs” on page 31.

DC power LED: This green LED provides status information about the power supply. During typical operation, both the ac and dc power LEDs are lit. For any other combination of LEDs, see “Power supply LEDs” on page 31.

Ethernet 1 link status LED: This green LED is lit when there is an active link connection on the 10BASE-T, 100BASE-TX, or 1000BASE-TX interface for Ethernet port 1.

Ethernet 1 activity LED: This green LED is lit when the server is transmitting or receiving signals to the Ethernet LAN that is connected to Ethernet port 1.

Server power features

This section contains information about how to properly turn your server on and off.

Turning on the server

You can turn on the server in any of the following ways:

- If the power cords are connected to a power source, you can press the power-control button on the front of the server.

Note: You can install a circular disk over the power-control button to prevent accidental manual power-off. This disk, known as the power-control-button shield, comes with your server.

- If the server is turned on and a power failure occurs, it restarts automatically when power is restored.
- You can turn on the server by using the Integrated System Management Processor (ISMP).
- You can turn on the server by using the optional Remote Supervisor Adapter.
- If your operating system supports the Wake on LAN[®] feature, the Wake on LAN feature can turn on the server.

Complete the following steps to manually turn on the server:

1. Review the information in “Safety information” on page 121.
2. Turn on all external devices, such as the monitor.
3. Plug the server power cords into the power source.
4. Press the power-control button on the front of the server.

Note: While the server is powering up, the power-on LED on the front of the server is lit.

Turning off the server

Complete the following steps to manually turn off the server:

1. Review the information in “Safety information” on page 121.
2. See your operating system documentation for the proper procedure to shut down the operating system.

Statement 5:



CAUTION:

The power control button on the device and the power switch on the power supply do not turn off the electrical current supplied to the device. The device also might have more than one power cord. To remove all electrical current from the device, ensure that all power cords are disconnected from the power source.

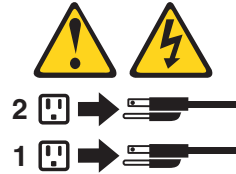

3. Press the power-control button on the front of the server. This will put the server in Standby mode.
4. Disconnect the server from the power source.

Notes:

- a. After you turn off the server, wait at least 5 seconds before you turn on the server again.
- b. You might need to press and hold the power-control button for more than 4 seconds to cause an immediate shutdown of the server and to force the power off. You can use this feature if the operating system stops functioning.

Standby mode

Standby mode refers to the condition in which the server operating system is not running and all core logic is shut down except for the service processor.

Complete the following steps to put the server into Standby mode:

1. See the operating-system documentation for the proper procedure to shut down the operating system.

Note: Each operating system is different. Read all the documentation about shutting down the operating system before continuing.

2. Press the power-control button on the front of the server.

You can put the server into Standby mode remotely by using the service processor.

Chapter 2. Configuring your server

The following configuration programs are provided with your server:

- **ServerGuide Setup and Installation CD**

The *ServerGuide Setup and Installation* CD provides software setup tools and installation tools that are specifically designed for your IBM server. Use this CD during the initial installation of your server to configure basic hardware features, such as ServeRAID™ and integrated RAID, and to simplify your network operating system (NOS) installation. (See “Using the ServerGuide Setup and Installation CD” for more information.)

- **Configuration/Setup Utility program**

This program is part of the *basic input/output system (BIOS)* code that comes with your server. You can use this program to configure serial port assignments, change interrupt request (IRQ) settings, change the drive startup sequence, set the date and time, and set passwords. You also can use this program to view the system configuration settings, for example, the number of installed microprocessors, the amount of installed memory, the BIOS diagnostics version level, and so on. See “Using the Configuration/Setup Utility program” on page 11 for more information.

- **ServeRAID programs**

The ServeRAID programs come with your server. If your server has a ServeRAID adapter installed or if you are using the RAID capabilities of the integrated SCSI controller, use the ServeRAID Manager program to define and configure your disk-array subsystem *before* you install your operating system. See “Using ServeRAID Manager” on page 13 for more information.

- **LSI Logic Configuration Utility**

With the built-in LSI Logic Configuration Utility program, you can configure the integrated SCSI controller and the devices that attach to it. See “Using the LSI Logic Configuration Utility program” on page 20.

- **Integrated System Management**

To update the Integrated System Management (ISM) firmware, see “Updating the integrated system-management firmware” on page 21 for more information.

- **Ethernet controller configuration process**

For instructions to configure the integrated Ethernet controller, see “Configuring the Ethernet controller” on page 21.

- **IBM Director**

IBM Director is a work-group-hardware-management tool that you can use to centrally manage xSeries servers; IBM Netvista, IntelliStation®, and ThinkPad® computers; and non-IBM Intel-microprocessor-based systems. IBM Director automates tasks such as inventory-taking, monitoring of environmental sensors (such as temperature, voltage and fans), alerting, and system-health information.

For more information and instructions about IBM Director, see the *IBM Director User's Guide* on the CD that comes with your server.

Using the ServerGuide Setup and Installation CD

The *ServerGuide Setup and Installation* CD includes an easy-to-use setup and installation program that is specifically designed for your IBM server. The ServerGuide program detects the server model and hardware options that are installed and uses that information during setup to configure the hardware. The

ServerGuide program simplifies network operating system (NOS) installations by providing updated device drivers and, in some cases, installing them automatically.

If a later version of the ServerGuide program is available, you can download a free image of the *ServerGuide Setup and Installation CD*, or you can purchase the CD. To download the latest ServerGuide program, go to the IBM ServerGuide Web page at <http://www.ibm.com/pc/qtechinfo/MIGR-4ZKPPT.html>. To purchase the latest *ServerGuide Setup and Installation CD*, see the “ServerGuide Updates” flyer that comes with your server library, or go to the ServerGuide fulfillment Web site at <http://www.ibm.com/pc/coupon/>.

The ServerGuide program has the following features to make setup easier:

- An easy-to-use interface with online help
- Diskette-free setup and configuration programs that are based on detected hardware
- A system BIOS update program, which updates the BIOS code directly from the CD
- Device drivers that are provided for your server model and detected hardware
- NOS partition size and file-system type that are selectable during setup

System partition

The ServerGuide program creates a 50 MB system partition on the default drive. The system partition contains server-specific utility programs such as service processor disk operating system (DOS) utilities, system diagnostics, flash BIOS updates, and other programs. Programs in the system partition vary by server model, and not all server models run utility programs from the system partition. To determine which ones do, start the *ServerGuide Setup and Installation CD* and view the online overview.

After setup is complete, you can access programs in the system partition by restarting the server and pressing Alt+F1 when the prompt is displayed. The **System Partition** menu displays the programs that are available on your server model.

Typical NOS installation

You can use the ServerGuide program to shorten your installation time. The ServerGuide program provides the device drivers that are required for your hardware and for the NOS that you are installing. This section describes a typical ServerGuide NOS installation.

Note: Features and functions can vary slightly with different versions of the ServerGuide program.

1. After you have completed the setup process, the NOS installation program starts. (You will need your NOS CD to complete the installation.)
2. The ServerGuide program stores information about the server model, service processor, hard disk drive controllers, and network adapters. Then, the program checks the CD for newer device drivers. This information is stored and then passed to the NOS installation program.
3. With some NOS installations, you can create a NOS-replication diskette for setting up additional servers. This diskette contains the Internet protocol (IP) address, server name, and other selections.
4. The ServerGuide program presents NOS partition options that are based on your NOS selection and the installed hard disk drives.

5. If you are installing the NOS from diskette, the ServerGuide program lists the diskettes that you must create and the optional diskettes that you might want to create. The diskettes that you can create are the device-driver diskettes for the installed adapters or controllers.
6. The ServerGuide program prompts you to insert your NOS CD and restart the server. At this point, the installation program for the NOS automatically completes the installation.

Setting up or updating multiple servers

You can use the ServerGuide program to create diskettes that help you set up or update multiple servers. You can modify information on the diskettes as you use them to set up or update other servers.

Note: Availability and function can vary by server model and by the hardware that is installed.

You can create a setup-replication diskette, which contains your hardware configuration selections. Use this diskette to replicate selections to other servers that are of the same model.

You can create a NOS-replication diskette, which contains information that you need to complete multiple installations. Not all operating systems support NOS-replication diskettes.

Installing your NOS without ServerGuide

If you have already configured the server hardware and you decide not to use the ServerGuide program to install your NOS, complete the following steps to download the latest NOS installation instructions from the IBM Support Web page:

1. Go to <http://www.ibm.com/pc/support/>.
2. Under **Browse**, click **Servers**.
3. From the **Family** drop-down list, select your server model.
4. If NOS installation instructions are available for your server model, **OS installation** is in the list in the left pane of the Web page. Click **OS installation** and select the instructions for your NOS.

Using the Configuration/Setup Utility program

This section provides instructions to start the Configuration/Setup Utility program and descriptions of the available menu choices.

Starting the Configuration/Setup Utility program

To start the Configuration/Setup Utility program, complete the following steps:

1. Turn on the server, and watch the monitor screen.
2. When the message Press F1 for Configuration/Setup appears, press F1.

Notes:

- a. If you have set both levels of passwords (power-on and administrator), you must type the administrator password to access the full Configuration/Setup Utility main menu. Without the administrator password, limited Configuration/Setup Utility program functions are available.
- b. You can set an administrator password only if the optional IBM Remote Supervisor Adapter is installed in your server

3. Follow the instructions that appear on the screen.

Using passwords

The **System Security** choice appears only on the full Configuration/Setup Utility menu. After you select this choice, you can implement two levels of password protection: power-on password and administrator password.

Power-on password

After you set a power-on password, you can enable the Unattended-Start mode. This locks the keyboard and mouse but enables the system to start the operating system. The keyboard and mouse remain locked until you type the correct password.

You can use any combination of up to seven characters (A–Z, a–z, and 0–9) for your power-on password. Keep a record of your password in a secure place. When a power-on password is set, POST is not completed until you type the password. If you forget the power-on password, you can regain access to the server through one of the following methods:

- If an administrator password is set, type the administrator password at the power-on prompt. (If necessary, see “Administrator password” for details.) Start the Configuration/Setup Utility program, and change the power-on password.
- Remove the battery, and then reinstall the battery (see “Replacing the battery” on page 68 for instructions).
- Change the position of the power-on password override switch (switch 6 on switch block 1) to bypass the power-on password check. You can then start the Configuration/Setup Utility program and change the power-on password.

Notes:

1. Before changing any switch settings or moving any jumpers, turn off the server; then, disconnect all power cords and external cables.
2. Any system-board switch or jumper blocks that are not shown in the illustrations in this book are reserved.
3. Changing the position of the power-on password override switch bypasses the power-on password check the next time the server is turned on. You do not need to move the switch back after the password is overridden. The default position is Off. To bypass the power-on password check, move the switch to the opposite position.
4. Changing the position of this switch does not affect the administrator password.

Administrator password

Select this choice to set an administrator password. The administrator password provides access to all choices on the Configuration/Setup Utility main menu.

Note: This choice is available on the Configuration/Setup Utility menu only if the optional IBM Remote Supervisor Adapter is installed in your server.

When you use an administrator password, you can set, change, or delete both the administrator and power-on passwords and allow a user to change a power-on password. You can use any combination of up to seven characters (A–Z, a–z, and 0–9) for your administrator password. Keep a record of your password in a secure place.

Attention: If an administrator password is set and then forgotten, it cannot be overridden or removed. You must replace the system board.

The following table provides a summary of the password features.

Table 2. Power-on and administrator password features

Type of password	Features
Power-on password	<ul style="list-style-type: none"> Type the password to complete the system startup. All choices are available on the Configuration/Setup Utility main menu.
Administrator password	<ul style="list-style-type: none"> No password is required to complete the system startup. Type the password to access the Configuration/Setup Utility program. All choices are available on the Configuration/Setup Utility main menu.
Administrator <i>and</i> power-on password	<ul style="list-style-type: none"> You can type either password to complete the system startup. The administrator password provides access to all choices on the Configuration/Setup Utility main menu. You can set, change, or delete both the administrator and power-on passwords and allow a user to change a power-on password. The power-on password provides access to a limited set of choices on the Configuration/Setup Utility main menu. This limited access might include changing or deleting the power-on password.

Using ServeRAID Manager

You can use the ServeRAID Manager program, provided on the *IBM ServeRAID Support CD*, to:

- Configure a redundant array of independent disks (RAID)
- Restore a SCSI hard disk drive to factory-default settings, erasing all data
- View your RAID configuration and associated devices
- Monitor operation of your RAID controllers

The ServeRAID Manager program operates in two ways:

- Startable CD mode
- As an installed software program

The information in this section provides instructions for running ServeRAID Manager in Startable CD mode to configure your integrated SCSI controller with RAID capabilities and perform an initial RAID configuration on your server. See the ServeRAID documentation on the *IBM ServeRAID Support CD* for additional information about RAID technology and instructions for using ServeRAID Manager to configure your integrated SCSI controller with RAID capabilities. For information about installing ServeRAID Manager, see the documentation on the *IBM ServeRAID Support CD*.

Notes:

1. The integrated SCSI controller with RAID capabilities in your server supports only RAID level-1 with a hot spare device. Installing an optional ServeRAID-5i controller provides additional RAID levels. If a ServeRAID-5i controller is installed and later removed, you must re-enable the on-board SCSI controller using the Configuration/Setup Utility program (see “Starting the Configuration/Setup Utility program” on page 11).
2. If you install a different type of RAID adapter in your server, use the configuration method supplied with the RAID adapter to view or change SCSI settings for attached devices.

When you run the ServeRAID Manager program from the startable *IBM ServeRAID Support CD*, you are using Startable CD mode, in which you can configure your controller *before* you install your operating system.

To run the ServeRAID Manager program in Startable CD mode, turn on the server; then, insert the *IBM ServeRAID Support CD* into the CD-ROM drive. If the ServeRAID Manager program detects an unconfigured controller and ready drives, the program automatically starts the Configuration wizard, and a window similar to that shown in Figure 1 opens.

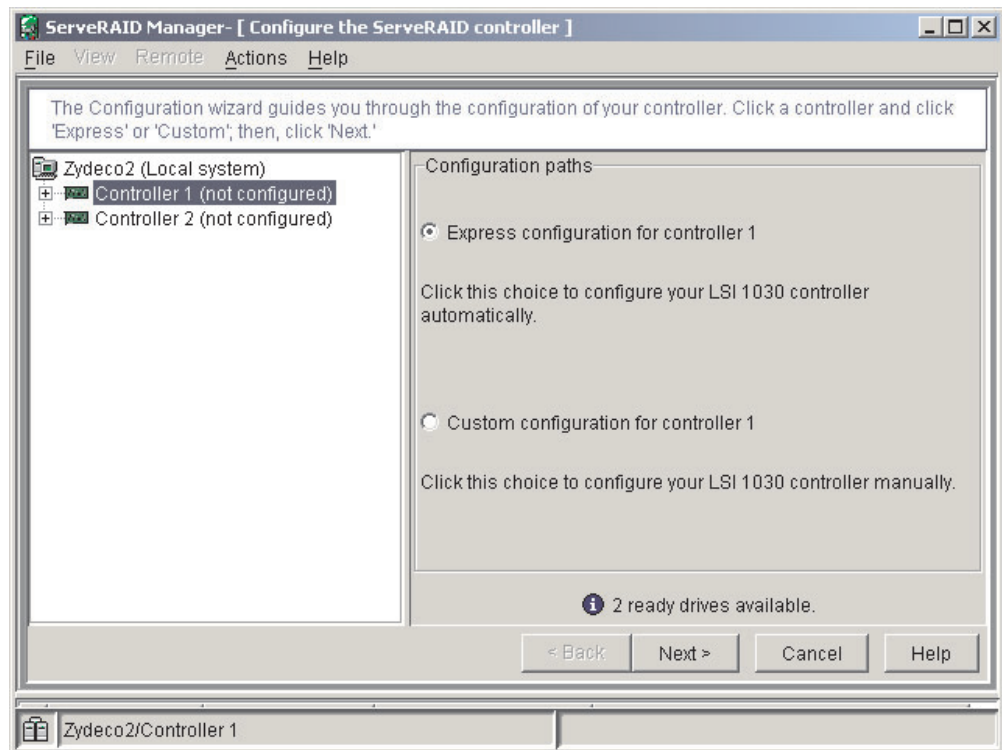

Figure 1. Configuration wizard window

Configuring the controller

You can use the Configuration wizard to configure your controller. The Configuration wizard provides two configuration options: Express and Custom. Express configuration automatically configures your controller, and you can use Custom configuration to configure your controller manually.

Note: If the integrated RAID controller has two channels, it will appear in the ServeRAID Manager tree as two controller objects. However, you can configure only one array and one RAID level-1 logical drive.

Using Express configuration

Express configuration automatically configures your controller, creates an array by grouping together the first two physical drives that appear in the ServeRAID Manager tree, and it creates a RAID level-1 logical drive.

Complete the following steps to use Express configuration:

1. In the ServeRAID Manager tree, click the controller.
2. Click **Express configuration**.

3. Click **Next**. The “Configuration summary” window opens.
4. Review the information that is displayed in the Configuration summary window. To change the configuration, click **Modify arrays**.

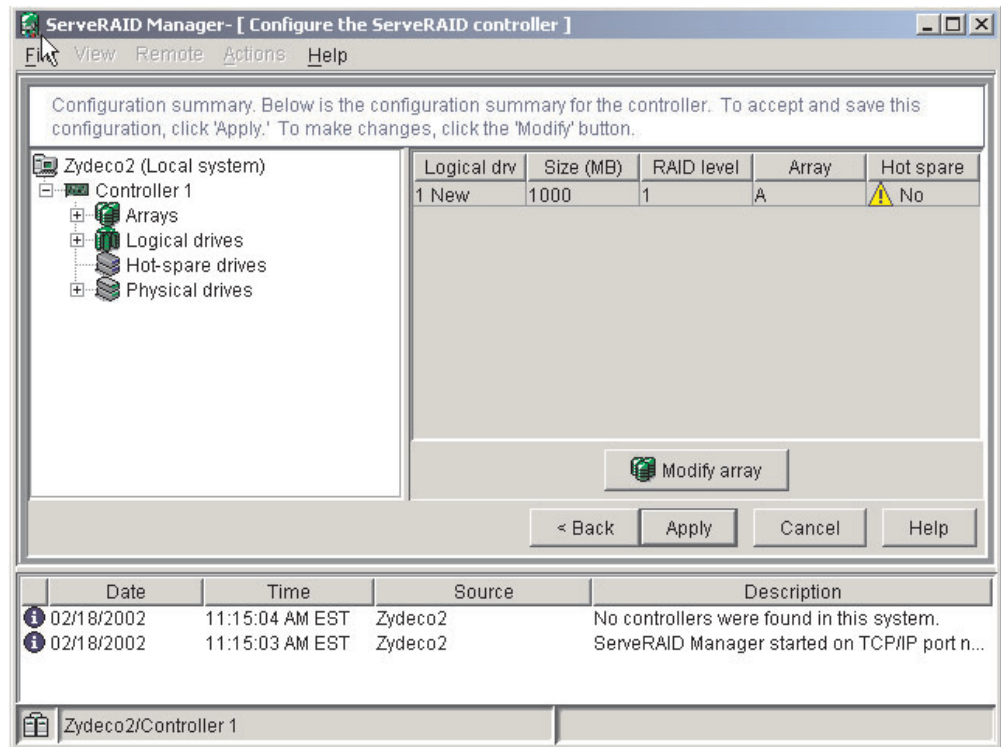

Figure 2. Configuration summary window

5. Click **Apply**; then, click **Yes** when asked if you want to apply the new configuration. The configuration is saved in the controller and in the physical drives.
6. Exit from the ServeRAID Manager program and remove the CD from the CD-ROM drive.
7. Restart the server.

Using Customer configuration

To configure your controller manually, use Custom configuration to select which two physical drives you want to configure and create a hot-spare drive.

Complete the following steps to use Custom configuration:

1. In the ServeRAID Manager tree, click the controller.
2. Click **Custom configuration**.

3. Click **Next**. The “Create arrays” window opens.

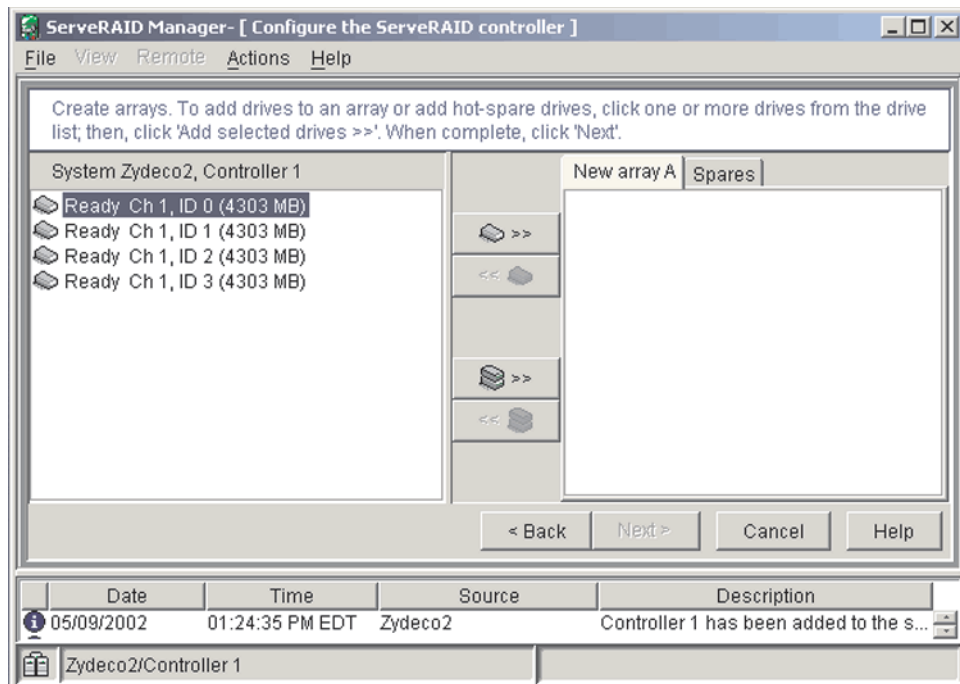



Figure 3. Create arrays window

4. From the list of ready drives, select the two drives you want to move to the array.
5. Click  (Add selected drives) to add the drives to the array.
6. Complete the following steps, if you want to configure a hot-spare drive:
 - a. Click the **Spares** tab.
 - b. Select the physical drive you want to designate as the hot-spare drive; then, click  (Add selected drives).

7. Click **Next**. The Configuration summary window opens.

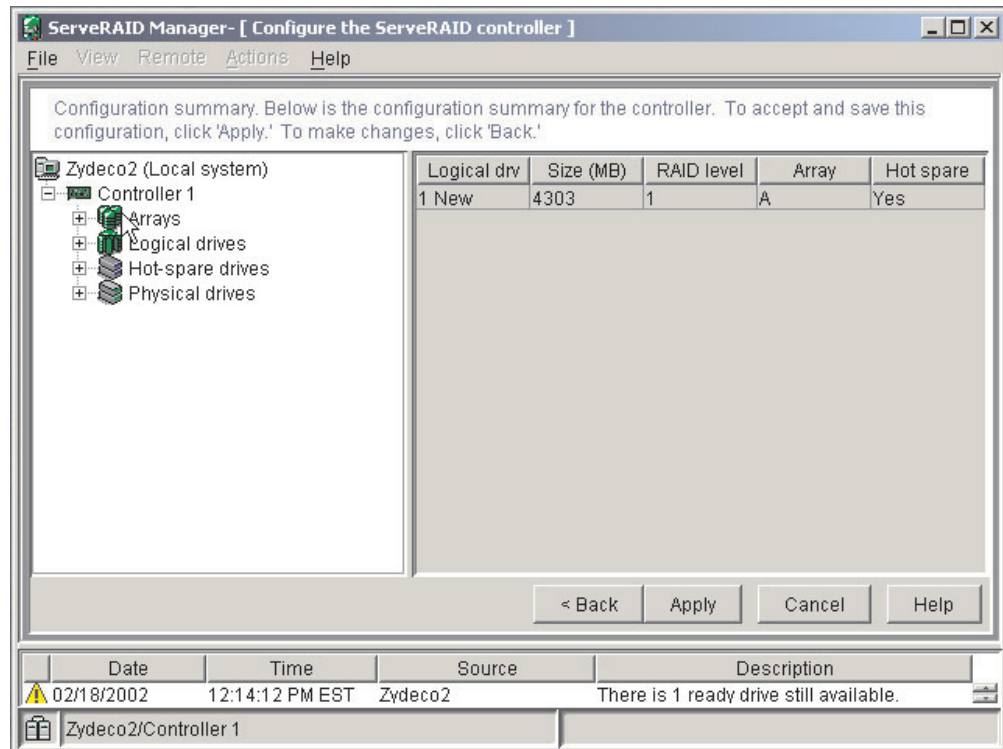

Figure 4. Configuration summary window

8. Review the information that is displayed in the “Configuration summary” window. To change the configuration, click **Back**.
9. Click **Apply**; then, click **Yes** when asked if you want to apply the new configuration. The configuration is saved in the controller and in the physical drives.
10. Exit from the ServeRAID Manager program, and remove the CD from the CD-ROM drive.
11. Restart the server.

Viewing your configuration

You can use ServeRAID Manager to view information about RAID controllers and the RAID subsystem (such as arrays, logical drives, hot-spare drives, and physical drives).

To view information, expand the ServeRAID Manager tree; then, click the relevant tree object. Detailed information about the selected device appears in the right pane.

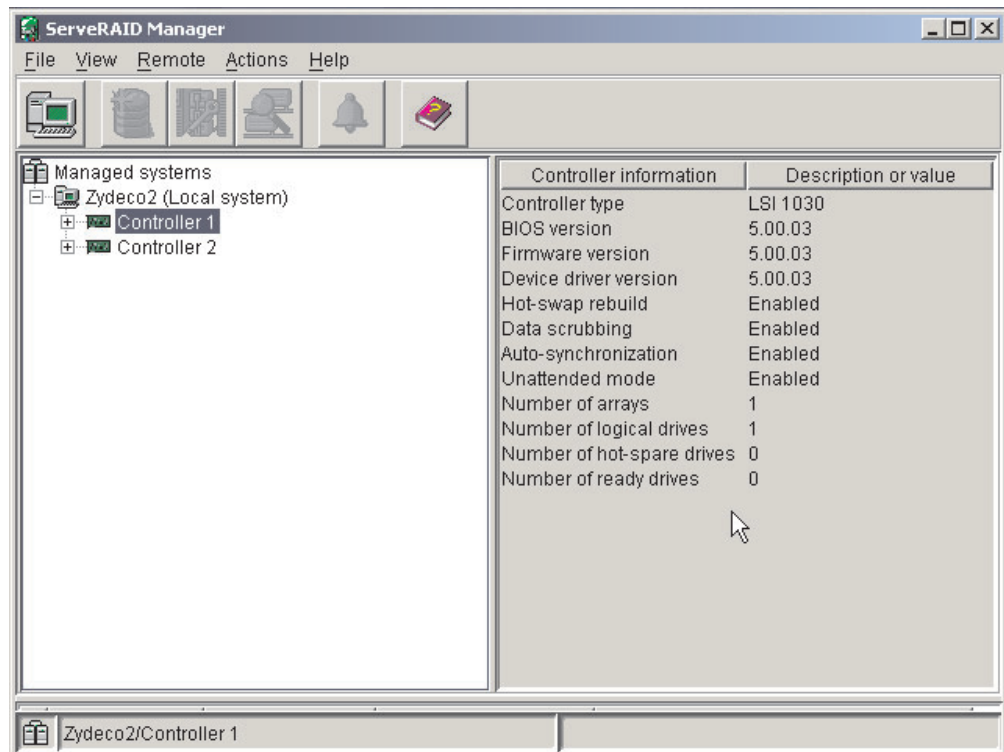



Figure 5. ServeRAID Manager window

To display available actions for an item, click the item in the ServeRAID Manager tree and click **Actions**.

Getting assistance

For more information about ServeRAID Manager, see the online help system. To start the help system, either click  (Information about this window) on the toolbar, or select an item from the **Help** menu.

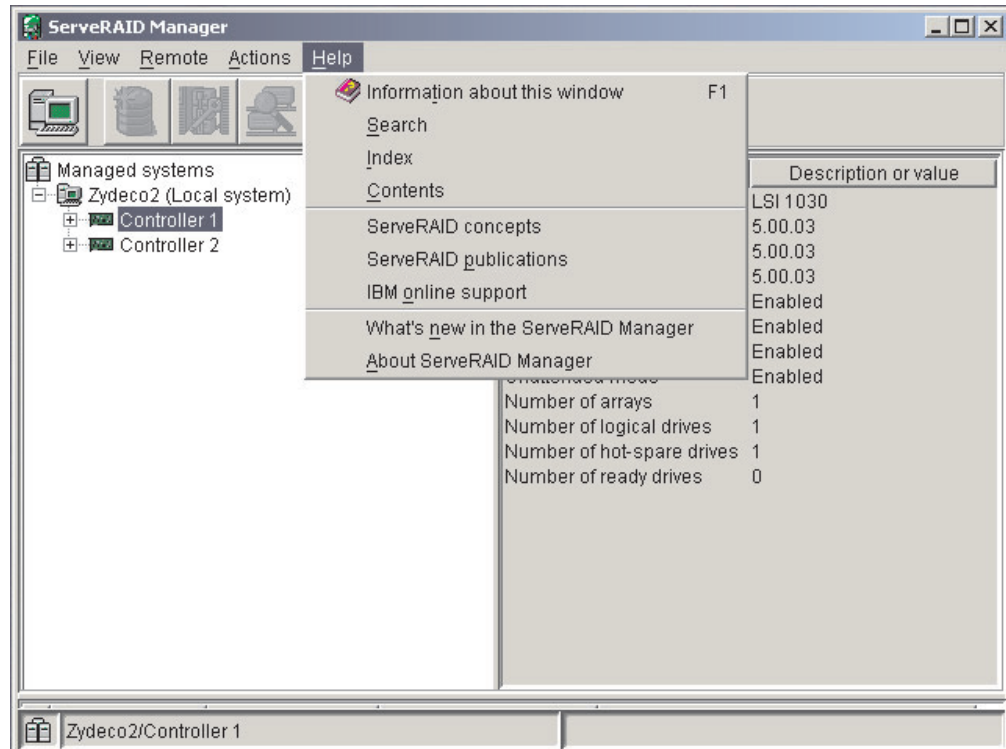

Figure 6. ServeRAID Manager help menu

The help system (ServeRAID Assist) will open within the ServeRAID Manager interface.

To learn more about the ServeRAID Manager tree objects and the actions that apply to them, select a tree object, and click **Actions** → **Hints and tips**. ServeRAID Assist will start, and information about the tree object will appear in the right pane of ServeRAID Manager.

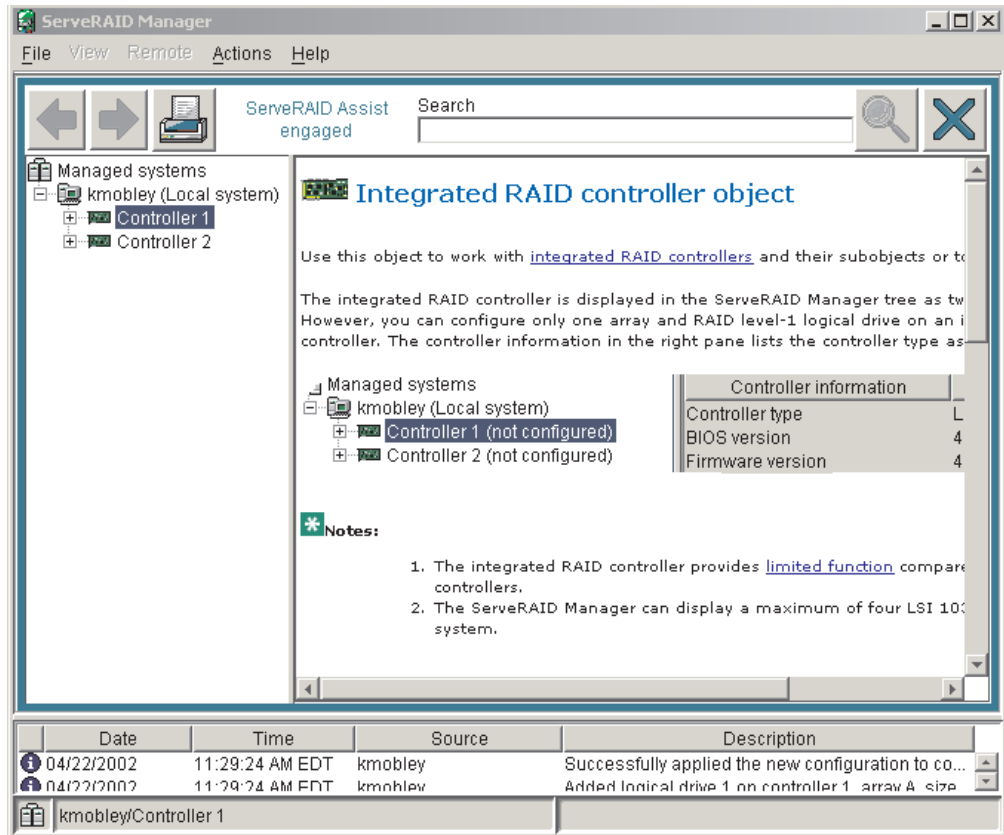

Figure 7. Hints and tips feature

Using the LSI Logic Configuration Utility program

You can use the built-in, menu-driven LSI Logic Configuration program to:

- Perform a low-level format on a hard disk drive
- Set the SCSI device scan order
- Set the SCSI ID for a controller

Notes:

1. The integrated SCSI controller with RAID capabilities in your server supports RAID level 1 operation.
2. If your server has a ServeRAID-5i controller installed, you can use ServeRAID Manager to configure the integrated SCSI controller with RAID capabilities for additional RAID levels. If a ServeRAID-5i controller is installed and later removed, you must re-enable the on-board SCSI controller in using the Configuration/Setup Utility program (see "Starting the Configuration/Setup Utility program" on page 11).

Complete the following steps to start the LSI Logic Configuration Utility program:

1. Turn on the server and watch the monitor screen.
2. When the Press CTRL C to start LSI Logic Configuration Utility prompt appears, press Ctrl+C.

Note: If an administrator password has been set, a prompt appears asking you to type the password to start the LSI Logic Configuration Utility program.

3. Use the arrow keys to select a controller (channel) from the list of adapters; then, press Enter.
4. Follow the instructions on the screen to change the settings of the selected items; then, press Enter.

You can use the LSI Logic Configuration Utility program to perform a low-level format on a SCSI hard disk drive. Complete the following steps to format a drive:

Attention: The Low-Level Format program erases all data and programs. Backup any data before running the Low-Level Format program.

1. Select the controller channel for the drive from the list of adapters.
2. Select **Device Properties**.
3. Use the arrow keys to highlight the drive to format.
4. Use the arrow keys or the End key to scroll to the right.
5. Highlight the **Format** item; then, press Enter to start.

Updating the integrated system-management firmware

To update the integrated system-management (ISM) firmware for the integrated system-management processor (ISMP), you must download the image of the Integrated System Management Firmware Update Utility program for your server from the IBM Support Web site at <http://www.ibm.com/pc/support/> on the World Wide Web. You can then run the Integrated System Management Firmware Update Utility program to create an Integrated System Management Firmware Update Utility diskette that is used to update the ISM firmware. This diskette updates the ISM firmware only and does not affect any device drivers.

Complete the following steps to update the ISMP firmware:

1. Turn off your server.
2. Insert the diskette into the diskette drive.
3. Turn on your server. If your server does not start from the diskette drive, use the Configuration/Setup Utility program to configure the diskette drive as a startup device. See “Using the Configuration/Setup Utility program” on page 11. Then, go back and start with step 1.
4. From the main menu, select **Update System Management Firmware** and press Enter.
5. Follow the on-screen instructions to complete the update.

Configuring the Ethernet controller

The server comes with an integrated dual-port Ethernet controller. This controller provides an interface for connecting to 10-Mbps, 100-Mbps, and 1000-Mbps networks and provides full-duplex (FDX) capability, which enables simultaneous transmission and reception of data on the Ethernet local area network (LAN).

To use the Ethernet controller, connect a Category 5 or higher unshielded twisted-pair (UTP) cable to either of the two Ethernet ports on the rear panel of the server.

The Ethernet connectors on the rear panel each have two LEDs. When the Ethernet link-status LED is on, there is an active connection on the Ethernet port. When the Ethernet transmit/receive TX/RX LED is on, there is activity between the server and the network. For a description of the server Ethernet ports, see “Ethernet ports” on page 76.

When you connect the server to the network, the Ethernet controller automatically detects the data-transfer rate (10 Mbps, 100 Mbps, or 1000Mbps) on the network and sets the controller to operate at the appropriate rate. In addition, if the Ethernet port that the server is connected to supports auto-negotiation, the Ethernet controller will set the appropriate duplex state. That is, the Ethernet controller will adjust to the network data rate, whether the data rate is standard Ethernet (10BASE-T), Fast Ethernet (100BASE-TX), Gigabit Ethernet (1000BASE-T), half duplex (HDX), or full duplex (FDX). The controller supports half-duplex (HDX) and full-duplex (FDX) modes at all speeds.

The Ethernet controller is a PCI Plug and Play device. You do not need to set any jumpers or configure the controller for the operating system before you use the controller. However, you must install a device driver to enable the operating system to access the controller. The device driver is provided on the *ServerGuide Setup and Installation* CD.

If you install an optional Ethernet adapter or use both Ethernet ports on your server, you can use optional modes, such as teaming, priority packets, and virtual LANs, which provide higher performance and throughput for the server. These modes apply to the integrated Ethernet controller and to the controllers on the supported Ethernet adapters.

Teaming mode

Teaming options increase throughput and fault tolerance when running with Windows NT®, Windows® 2000, or NetWare 4.1x or later.

- **Adapter fault tolerance (AFT)** provides automatic redundancy for the Ethernet controller. If the primary controller fails, the optional Ethernet adapter takes over. Adapter fault tolerance supports from 2 to 4 controllers per team.
- **Adaptive load balancing (ALB)** enables you to balance the transmission data flow among 2 to 4 Ethernet controllers. ALB also includes the AFT option. You can use ALB with any 100BASE-TX or 1000BASE-T switch.
- **Cisco Fast EtherChannel (FEC)** creates a team of 2 to 4 Ethernet controllers to increase transmission and reception throughput. FEC also includes the AFT option. You can only use FEC with a switch that has FEC capability.

Priority packet mode

Priority packet is a traffic-prioritization utility that you can use to set up filters to process high-priority traffic before normal traffic. You can send information from critical nodes or applications with an indicated priority. Because you set this priority at the host or entry point of the network, the network devices can base forwarding decisions on priority information defined in the packet.

Priority packet information is available on the IBM Networking Web site at <http://www.ibm.com/networking/support>.

Priority packet prioritizes traffic based on priority filters. These are parameters you assign to outgoing (transmit) packets. Using the Priority Filter wizard, you can set up predefined or custom priority filters based on a node (MAC) address, Ethernet type, or by various properties of the protocol and port. Priority packet provides two different methods for prioritizing traffic: IEEE 802.1p tagging and high priority queue.

IEEE 802.1p is an IEEE standard for tagging, or adding additional bytes of information to packets with different priority levels. Packets are tagged with 4 additional bytes, which increase the packet size and indicate a priority level. When you send these packets out on the network, the higher priority packets are transferred first. Priority packet tagging (also known as traffic class expediting) enables the Ethernet controller to work with other elements of the network (such as switches and routers) to deliver priority packets first. You can assign specific priority levels from 0 (low) to 7 (high).

You can assign values to packets based on their priorities when you use the IEEE 802.1p standard for packet tagging. This method requires a network infrastructure that supports packet tagging. The routing devices receiving and transferring these packets on the network must support 802.1p for tagging to be effective.

After you set up the priority filter in priority packet, you must start PROSet, click the Advanced tab, and select **QoS Packet Tagging** from the list.

Note: IEEE 802.1p tagging increases the size of the packets it tags. Some hubs and switches will not recognize the larger packets and will drop them. Check the hub or switch documentation to see if they support 802.1p. (You can configure the switch to strip the tags from the packets and send it on to the next destination as normal traffic.) If these devices do not support 802.1p or if you are not sure, use high priority queue (HPQ) to prioritize network traffic.

The requirements for effectively using IEEE 802.1p tagging are:

- The other devices receiving and routing 802.1p tagged packets must support 802.1p.
- The adapters on these devices must support 802.1p. The Ethernet controller in the server, all IBM 10/100 Ethernet Security Adapters, and IBM 10/100 Ethernet Server Adapters support 802.1p.
- The adapter cannot be assigned to an adapter team.
- If you are setting up VLANs and packet tagging on the same adapter, you must start PROSet, click the Advanced tab, and select **QoS Packet Tagging** from the list.

If the network infrastructure devices do not support IEEE 802.1p or you are not sure, you can still define filters and send packets as high priority. Although high priority queue (HPQ) does not provide the precise priority levels of 802.1p tagging, it does assign traffic as either high or low priority and sends high priority packets first. Therefore, if there are multiple applications on a system sending packets, the packets from the application with a filter are sent out first. HPQ does not change network routing, nor does it add any information to the packets.

To assign HPQ, you can specify it using priority packet mode when you create or assign a filter.

To effectively use HPQ, the adapter cannot be assigned to an adapter team.

Virtual LAN mode

A virtual LAN (VLAN) is a logical grouping of network devices put together as a LAN, regardless of their physical grouping or collision domains. Using VLANs increases network performance and improves network security.

VLANs offer you the ability to group users and devices together into logical workgroups. This can simplify network administration when connecting clients to servers that are dispersed geographically across a building, campus, or enterprise network.

Typically, VLANs are configured at the switch and any system can be a member of one VLAN per installed network adapter. The Ethernet controller supersedes this by communicating directly with the switch, enabling multiple VLANs on a single network adapter (up to 64 VLANs).

When you set up VLAN membership, the Ethernet controller must be attached to a switch that has VLAN capability. You also need to use Windows 2000, Windows NT 4.0 or later, or Novell NetWare 4.1x or later.

Notes®:

1. Windows NT versions prior to 4.0 do not support VLANs.
2. VLANs require Windows NT 4.0 with Service Pack 3.0 and the network driver interface specifications (NDIS) driver hotfix from Microsoft®.
3. In Windows NT, VLANS cannot be implemented on controllers that have been configured for teaming options. Netware can support teaming options and VLANS on the same adapters.

Complete the following steps to join a VLAN from Windows NT 4.0:

1. Create a VLAN on the switch. Use the parameters you assign there to join the VLAN from the server. See the switch documentation for more information.
2. Double-click the **Start Proset** icon in the Control Panel window.
3. On the Adapters page, right click on the adapter that you want to be on the VLAN.
4. In IBMSet, click **Add VLAN** for the first adapter or click **Join VLAN** for remaining adapters. Note that VLANs cannot be assigned to adapters that are already defined to have an adapter teaming option.
5. Type the VLAN ID and VLAN name. The VLAN ID must match the VLAN ID of the switch. The VLAN name is for information only and does not need to match the name on the switch.
6. Repeat steps 3 through 5 for each VLAN you want the server to join. The VLANs you add are listed on the Adapters page.
7. Click **Close**, and restart the server.

Chapter 3. Diagnostics

This section provides basic troubleshooting information to help you resolve some common problems that might occur with your server.

If you cannot locate and correct the problem using the information in this section, see Appendix A, “Getting help and technical assistance,” on page 119 for more information.

General checkout

The server diagnostic programs are stored in upgradeable read-only memory (ROM) on the system board. These programs are the primary method of testing the major components of the server: the system board, Ethernet controller, video controller, RAM, keyboard, mouse (pointing device), diskette drive, serial ports, and hard disk drives. You can also use the diagnostic programs to test some external devices. See “Diagnostic programs and error messages” on page 28.

If you cannot determine whether a problem is caused by the hardware or by the software, run the diagnostic programs to test the hardware.

When you run the diagnostic programs, a single problem might cause several error messages. When this occurs, work to correct the cause of the first error message. After you correct the cause of the first error message, the other error messages might not occur the next time you run the test.

A failed system might be part of a shared hard disk drive cluster (two or more systems sharing one or more external storage devices). Before you run diagnostics, verify that the failing system is not part of a shared hard disk drive cluster.

A system might be part of a cluster if:

- The system is identified as part of a cluster.
- One or more external storage units are attached to the system and at least one of the attached storage units is also attached to another system or unidentifiable source.
- One or more systems are located near the failing system.

If the failing system is suspected to be part of a shared hard disk drive cluster, run all diagnostic tests except the diagnostic tests that test the storage unit (hard disk drive residing in the storage unit) or the storage adapter attached to the storage unit.

Notes:

1. For systems that are part of a shared hard disk drive cluster, run one test at a time in looped mode. Do not run all tests in looped mode. This could enable the hard disk drive diagnostic tests.
2. If multiple error codes are displayed, diagnose the first error code that is displayed.
3. If the server stops with a POST error, go to “POST error codes” on page 100.
4. If the server stops and no error is displayed, go to “Undetermined problems” on page 110.
5. For power supply problems, see “Power-supply LED errors” on page 99.
6. For safety information, see “Safety information” on page 121.

7. For intermittent problems, check the error log.

Follow the steps in this procedure to identify system problems.

001 IS THE SYSTEM PART OF A CLUSTER?

YES. Schedule maintenance for the system. Shut down all systems related to the cluster. Run the storage test.

NO. Go to step **002**.

002 IF THE SYSTEM IS NOT PART OF A CLUSTER:

1. Turn off the server and all external devices.
2. Check all cables and power cords.
3. Set all display controls to the middle position.
4. Turn on all external devices.
5. Turn on the server.
6. Record any POST error messages that are displayed on the screen. If an error is displayed, look up the first error in the “POST error codes” on page 100.
7. Check the information LED panel System Error LED; if it is on, see “Diagnostic panel system-error LED” on page 84.
8. Check the system-error log. If the system recorded an error, see Chapter 6, “Symptom-to-FRU index,” on page 81.
9. Start the diagnostic programs.
10. Check for the following responses:
 - One beep.
 - Readable instructions or the main menu.

003 DID YOU RECEIVE BOTH OF THE CORRECT RESPONSES?

NO. Find the failure symptom in Chapter 6, “Symptom-to-FRU index,” on page 81.

YES. Run the diagnostic programs. If necessary, see “Diagnostic programs and error messages” on page 28.

If you receive an error, see Chapter 6, “Symptom-to-FRU index,” on page 81.

If the diagnostic programs were completed successfully and you still suspect a problem, see “Undetermined problems” on page 110.

Diagnostic tools overview

The following tools are available to help you identify and resolve hardware-related problems:

- **POST beep codes and error messages**

The power-on self-test (POST) generates beep codes and messages to indicate successful test completion or the detection of a problem. See “POST error logs” on page 27 for more information.

- **Error log**

The POST error log contains the three most recent error codes and messages that the system has generated during POST. The system-error log contains all the error messages that were issued during POST.

To view the contents of the error logs, start the Configuration/Setup Utility program; then, select **Error Logs** from the main menu. See “Viewing the system-error log” on page 31 for more information.

- **ServerGuide error symptoms**
ServerGuide error symptoms are explained at “ServerGuide error symptoms” on page 28.
- **SCSI error messages**
For information on SCSI errors, see “Small computer system interface messages” on page 28 and “SCSI error codes” on page 106.
- **Diagnostic programs and error messages**
The server diagnostic programs are stored in read-only memory (ROM) on the system board. These programs are the primary method of testing the major components of your server. See “Diagnostic programs and error messages” on page 28 for more information.
- **Light Path Diagnostics**
The Light Path Diagnostics™ feature provides a series of LEDs that are built into your server so that you can quickly identify problems with server components by following the path of LEDs. See “Light Path Diagnostics” on page 32 for more information.
- **Error symptom charts**
These charts list problem symptoms, along with suggested steps to correct the problems. See the “Error symptoms” on page 91 for more information.

POST error logs

When you turn on the server, it performs a series of tests to check the operation of server components and some of the options installed in the server. This series of tests is called the power-on self-test, or POST.

If POST finishes without detecting any problems, a single beep sounds, and the first screen of your operating system or application program appears.

If POST detects a problem, more than one beep sounds, and an error message appears on your screen. See “Beep symptoms” on page 81 and “POST error codes” on page 100 for more information.

Notes:

1. If you have a power-on password or administrator password set, you must type the password and press Enter, when prompted, before POST will continue.
2. A single problem might cause several error messages. When this occurs, work to correct the cause of the first error message. After you correct the cause of the first error message, the other error messages usually will not occur the next time you run the test.

The POST error log contains the three most recent error codes and messages that the system generated during POST. The system-error log contains all messages issued during POST and all system status messages from the service processor.

You can view the contents of the system-error log from the Configuration/Setup Utility program or from the diagnostic programs.

Viewing error logs from the Configuration/Setup Utility program

To view error logs from the Configuration/Setup Utility program, start the Configuration/Setup Utility program; then, select **Error Logs** from the main menu. See Chapter 2, “Configuring your server,” on page 9 for more information.

Viewing error logs from diagnostic programs

To view error logs from diagnostic programs, complete the following steps:

1. Start the diagnostic programs.
2. Select **Hardware Info** from the top of the diagnostic programs screen.
3. Select **System Error Log** from the list that appears; then, follow the instructions on the screen.

See “Starting the diagnostic programs” on page 30 for more information.

ServerGuide error symptoms

Look for the symptom in the left column of the chart. Probable solutions to the problem are in the right column.

Table 3. ServerGuide Setup and Installation CD

Symptom	Suggested action
The <i>ServerGuide Setup and Installation</i> CD will not start.	<ul style="list-style-type: none">• Ensure that the server is supported and has a startable (bootable) CD-ROM drive.• If the startup (boot) sequence settings have been altered, ensure that the CD-ROM drive is first in the startup sequence.• If more than one CD-ROM drive is installed, ensure that only one drive is set as the primary drive. Start the CD from the primary drive.
The SCSI RAID program cannot view all installed drives, or the NOS cannot be installed.	<ul style="list-style-type: none">• Ensure that there are no duplicate SCSI IDs or IRQ assignments.• Ensure that the hard disk drive is connected properly.
The Operating System Installation program continuously loops.	Make more space available on the hard disk.
The ServerGuide program will not start your NOS CD.	Ensure that the ServerGuide program supports the NOS CD you have. See the <i>ServerGuide Setup and Installation</i> CD label for a list of supported NOS versions.
The NOS cannot be installed; the option is not available.	Ensure that your server supports the NOS. If the NOS is supported, either there is no logical drive defined (SCSI RAID systems) or the ServerGuide System Partition is not present. Run the ServerGuide program, and ensure that setup is complete.

Small computer system interface messages

If you receive a SCSI error message, see “SCSI error codes” on page 106.

Note: If your server does not have a hard disk drive, ignore any message that indicates that the BIOS is not installed.

Diagnostic programs and error messages

The server diagnostic programs are stored in upgradeable read-only memory (ROM) on the system board. These programs are the primary method of testing the major components of your server.

Diagnostic error messages indicate that a problem exists; they are not intended to be used to identify a failing part. Troubleshooting and servicing of complex problems that are indicated by error messages should be performed by trained service personnel.

Sometimes the first error to occur causes additional errors. In this case, the server displays more than one error message. Always follow the suggested action instructions for the *first* error message that appears.

The following sections contain the error codes that might appear in the detailed test log and summary log when the diagnostic programs are run.

The error code format is as follows:

fff-ttt-iii-date-cc-text message

where:

- fff** is the three-digit function code that indicates the function being tested when the error occurred. For example, function code 089 is for the microprocessor.
- ttt** is the three-digit failure code that indicates the exact test failure that was encountered. (These codes are for trained service personnel; see “Diagnostic error codes” on page 86).
- iii** is the three-digit device ID. (These codes are for trained service personnel; see “Diagnostic error codes” on page 86).
- date** is the date that the diagnostic test was run and the error recorded.
- cc** is the check value that is used to verify the validity of the information.
- text message** is the diagnostic message that indicates the reason for the problem.

Text messages

The diagnostic text message format is as follows:

Function Name: Result (test specific string)

where:

Function Name

is the name of the function being tested when the error occurred. This corresponds to the function code (fff) shown in the error code format in the previous section.

Result

can be one of the following:

- Passed** This result occurs when the diagnostic test is completed without any errors.
- Failed** This result occurs when the diagnostic test discovers an error.
- User Aborted** This result occurs when you stop the diagnostic test before it is complete.
- Not Applicable** This result occurs when you specify a diagnostic test for a device that is not present.
- Aborted** This result occurs when the test could not proceed, for example, because of the system configuration.
- Warning** This result occurs when a possible problem

is reported during the diagnostic test, such as when a device driver is not found.

test specific string

is additional information that you can use to analyze the problem.

Starting the diagnostic programs

Complete the following steps to start the diagnostic programs:

1. Turn on the server, and watch the screen.

Note: To run the diagnostic programs, you must start the server with the highest level password that is set. That is, if an administrator password is set, you must enter the administrator password, not the power-on password, to run the diagnostic programs.

2. When the message F2 for Diagnostics appears, press F2.
3. Type the appropriate password; then, press Enter.
4. Select either **Extended** or **Basic** from the top of the screen.
5. When the Diagnostic Programs screen appears, select the test you want to run from the list that appears; then, follow the instructions on the screen.

Notes:

- a. Press F1 while running the diagnostic programs to obtain help information. Press F1 from within a help screen to obtain online documentation from which you can select different categories. To exit from the help information and return to where you left off, press Esc.
- b. If the server stops during testing and you cannot continue, restart the server and try running the diagnostic programs again. If the problem remains, replace the component that was being tested when the server stopped.
- c. The keyboard and mouse (pointing device) tests assume that a keyboard and mouse are attached to the server.
- d. If you run the diagnostic programs with either no mouse or a USB mouse attached to your server, you will not be able to navigate between test categories using the **Next Cat** and **Prev Cat** buttons. All other functions provided by mouse-selectable buttons are also available using the function keys.
- e. You can test the USB keyboard by using the regular keyboard test. The regular mouse test can test a USB mouse. Also, you can run the USB interface test only if there are no USB devices attached.
- f. Select **Hardware Info** from the top of the screen to view server configuration information (such as system configuration, memory contents, interrupt request (IRQ) use, direct memory access (DMA) use, device drivers, and so on).

If the diagnostic programs do not detect any hardware errors but the problem persists during normal server operations, a software error might be the cause. If you suspect a software problem, see the information that comes with the software package.

Viewing the test log

When the tests are completed, select **Utility** from the top of the screen and then select **View Test Log** to view the test log.

Notes:

1. You can view the test log only while you are in the diagnostic programs. When you exit the diagnostic programs, the test log is cleared (saved test logs are not affected). To save the test log so that you can view it later, click **Save Log** on the diagnostic programs screen, and specify a location and name for the saved log file.
2. To save the test log to a diskette, you must use a diskette that you have formatted yourself; this function does not work with preformatted diskettes. If the diskette has sufficient space for the test log, the diskette may contain other data.

Viewing the system-error log

You can also view the system-error log from the diagnostic programs. See the instructions in “POST error logs” on page 27.

Diagnostic error message tables

For descriptions of the error messages that might appear when you run the diagnostic programs, see “Diagnostic error codes” on page 86.

Notes:

1. Depending on your server configuration, some of the error messages might not appear when you run the diagnostic programs.
2. If diagnostic error messages appear that are not listed in the tables, make sure that your server has the latest levels of BIOS, Advanced System Management Processor, ServeRAID, and diagnostics microcode installed.

Identifying problems using status LEDs

If the system-error LED on the front of the server is on, one or more LEDs inside the server or on the power supply will be on. Your server has LEDs to help you identify problems with some server components. These LEDs are part of the Light Path Diagnostics feature built into the server. By following the path of lights, you can quickly identify the type of system error that occurred.

Your server is designed so that any LEDs that are lit remain lit when the server shuts down as long as the ac power source is good and the power supply can supply +5 V dc current to the server. This feature helps you isolate the problem if an error causes the server to shut down. See “Light Path Diagnostics table” on page 34.

Power supply LEDs

The ac and dc power LEDs on the power supply provide status information about the power supply. The following illustration shows the location of the ac and dc power LEDs.

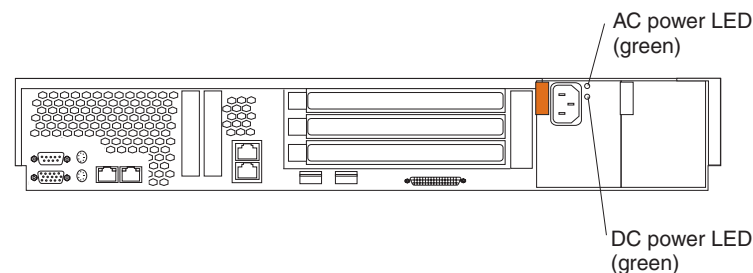

The following table describes the ac and dc power LEDs.

AC power LED	DC power LED	Description and action
On	On	The power supply is on and operating correctly.
On	Off	<p>There is a dc power problem.</p> <p>Possible causes:</p> <ol style="list-style-type: none"> 1. The server is not turned on (the power LED is flashing on the front of the server). Action: Press the power-control button to start the server. 2. The power supply has failed. Action: Replace the power supply.
Off	Off	<p>There is an ac power problem.</p> <p>Possible causes:</p> <ol style="list-style-type: none"> 1. There is no ac power to the power supply. Actions: Verify that: <ul style="list-style-type: none"> • The electrical cord is properly connected to the server. • The electrical outlet functions properly. 2. Disconnect the ribbon cable from connector J25 on the system board. If the ac power LED comes on, see “Undetermined problems” on page 110. 3. The power supply has failed. Action: Replace the power supply.

Light Path Diagnostics

If the system error LED on the front of the server is on, one or more LEDs inside the server might be on. Use the Light Path Diagnostics panel to quickly identify the type of error that occurred.

For LED locations, see “System-board LED locations” on page 47.

Your server is designed so that LEDs remain lit when the server shuts down, as long as the power supply is operating properly. This feature helps you to isolate the problem even if an error causes the server to shut down.

Diagnostic panel LEDs

The following illustration shows the LEDs on the diagnostics panel inside the server. See “Light Path Diagnostics” on page 34 for information about identifying problems using these LEDs.

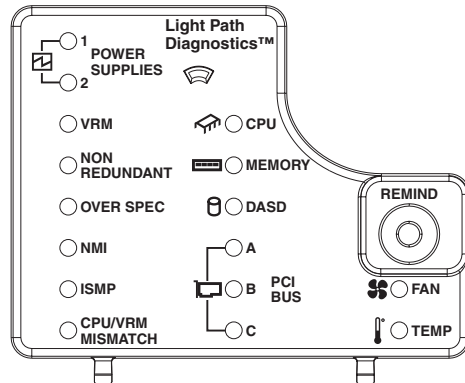

The Light Path Diagnostics LEDs are described in the following table.

Table 4. Diagnostics panel LEDs

Diagnostic panel LED	Description
POWER SUPPLY 1	The power supply in bay 1 failed.
POWER SUPPLY 2	The power supply in bay 2 failed.
VRM	Error on microprocessor voltage regulator module (VRM).
CPU	One or both microprocessors failed, or one is seated in the wrong socket.
NON-RED	Server power supplies are no longer redundant (applicable only with redundant power feature).
MEMORY	Memory failure. One or more dual inline memory modules (DIMMs) failed.
OVER SPEC	The system has shut down due to a system overload condition.
DASD	The SCSI backplane or a device connected to a SCSI bus failure.
NMI	Nonmaskable interrupt occurred.
PCI BUS A	Error occurred on an adapter in PCI-X slots 1 or 2 or one of the integrated PCI devices on the system board.
ISMP	Integrated system-management detects an internal error.
PCI BUS B	Error occurred on an adapter in PCI-X slots 3 or 4.
FAN	A fan (1, 2, 3, 4, 5, 6, 7, or 8) failed or is operating slowly.
CPU/VRM MISMATCH	The service processor detected a microprocessor or VRM mismatch.
PCI BUS C	Error occurred on an adapter in PCI slot 5.
TEMP	System temperature exceeded maximum rating.

Notes:

1. Depending on your server model, these items might appear in a different orientation on the LED panel.
2. The server supports a maximum of three PCI buses.
3. See the documentation that comes with the system-management software for more information about the service processor.

Remind button

You can use the Remind button to place the front panel system-error LED into the Remind mode. By pressing the button, you acknowledge the failure but indicate that you will not take immediate action. If a new failure occurs, the system-error LED will turn on again.

In the Remind mode, the system-error LED flashes every 2 seconds. The system-error LED remains in the Remind mode until one of the following situations occurs:

- All known problems are resolved
- The system is restarted
- A new problem occurs

You can use the Remind button to delay server maintenance until a later time. Also, resetting the system-error LED enables the LED to react to another error. If the LED is still flashing from the first error, it will not mask additional errors.

Light Path Diagnostics table

The system-error LED on the front of the server is lit when certain system errors occur. If the system-error LED on your server is lit, check to see which of the LEDs on the diagnostics panel inside the server are on.

Use the following table to help determine the cause of the error and the action you should take when the system error LED is on and:

Table 5. Light Path Diagnostics

Diagnostics panel LED on	Cause	Action
None	The system error log is 75% or more full or a PFA alert was logged.	Check the system-error log, and correct any problems. Disconnecting the server from all power sources for at least 20 seconds will turn off the system-error LED.
CPU	One of the microprocessors has failed, or a microprocessor is installed in the wrong socket.	<ol style="list-style-type: none">1. Check the microprocessor-error LEDs on the system board. If a microprocessor-error LED is on for a microprocessor socket that is empty, the microprocessors are not installed in the correct order (see “Installing a microprocessor” on page 58).2. Turn off the server, reseal the microprocessor indicated by the lit microprocessor-error LED, and restart the server.3. If the problem remains, replace the microprocessor.
VRM	One of the microprocessor VRMs has failed.	<ol style="list-style-type: none">1. Check the microprocessor VRM connectors on the system board to locate the error LED next to the failing component. See “Installing a microprocessor” on page 58 for information about installing VRMs.2. Turn off the server, reseal the microprocessor VRM indicated by the lit VRM error LED, and restart the server.3. If the problem remains, replace the microprocessor VRM.
MEMORY	A memory error occurred.	<ol style="list-style-type: none">1. Check the DIMM error LEDs on the system board.2. Replace the DIMM indicated by the lit DIMM error LED.

Table 5. Light Path Diagnostics (continued)

Diagnosics panel LED on	Cause	Action
PCI BUS A PCI BUS B PCI BUS C	An error occurred on PCI bus A, B, or C. An adapter in PCI slot 1, 2, 3, 4, or 5 or the system board caused the error.	<ol style="list-style-type: none"> 1. Check the adapter slots to locate the error LED next to the failing bus. 2. Check the error log for additional information. 3. If you cannot correct the problem from the error LED or information in the error log, try to determine the failing adapter by removing one adapter at a time from PCI bus A (PCI-X slots 1 or 2), PCI bus B (PCI-X slots 3 or 4), or PCI bus C (PCI slot 5) and restarting the server after each adapter is removed.
DASD	A hot-swap hard disk drive has failed on internal SCSI channel A.	<ol style="list-style-type: none"> 1. Check the error log for additional information. If the error log indicates a temperature problem and the fans are working correctly, verify that the ambient temperature is within normal limits (see “Features and specifications” on page 3). 2. If the amber hard disk status LED on one of the hot-swap hard disk drives is on, see “Server controls and indicators” on page 4 for more information.
NMI	A nonmaskable interrupt occurred. The PCI BUS LED will probably also be on.	<p>If the PCI BUS LED is on, follow the instructions for those LEDs.</p> <p>If the PCI BUS LED is not on, restart the server.</p>
ISMP	Integrated system management detects an internal error.	<ol style="list-style-type: none"> 1. Update ISMP firmware with latest level code. Unplug ac power, wait at least 30 seconds before restarting the system. 2. System board
POWER SUPPLY 1	The power supply in bay 1 has failed.	Replace the power supply in bay 1.
POWER SUPPLY 2	The power supply in bay 2 has failed.	Replace the power supply in bay 2.
NON-RED	<p>The server is operating in a nonredundant power mode, if:</p> <ul style="list-style-type: none"> • Two power supplies are installed in the server, and one power supply has either failed or is not connected to a functioning ac electrical outlet. • The system has exceeded the power capabilities of one of the redundant power supplies. <p>Note: This LED will not be lit if your server has only one power supply; however, the power is not redundant with only one power supply installed.</p>	<p>Check the power supply LEDs to determine the failing power supply.</p> <ol style="list-style-type: none"> 1. Check the power supply connections. 2. If a power supply has failed, replace the failing power supply. 3. If neither LED is lit, you can remove optional devices from the server to restore redundancy.
FAN	<p>One of the fans has failed or is operating too slowly.</p> <p>Note: A failing fan can also cause the TEMP and DASD LEDs to be on.</p>	The LED on the failing fan will be lit. Replace the fan.
TEMP	The system temperature has exceeded the maximum rating.	<ol style="list-style-type: none"> 1. Check to see if a fan has failed. If it has, replace the fan. 2. Make sure the room temperature is not too high. (See “Features and specifications” on page 3.)

Table 5. Light Path Diagnostics (continued)

Diagnostics panel LED on	Cause	Action
CPU/VRM MISMATCH	The service processor detected a microprocessor or VRM mismatch.	<ol style="list-style-type: none"> 1. Move the microprocessor in socket 1 to socket 2, and move the microprocessor in socket 2 to socket 1. 2. Ensure that both microprocessors are of the same type, with the same core frequency and the same L2 size. 3. Ensure that both VRMs are of the same type. 4. Ensure that both VRMs are supported in your server model. 5. If a microprocessor is missing from socket 1, install a microprocessor in socket 1.
None	The Light Path Diagnostics feature has not detected a system error.	None

If the system error LED is off, the Light Path Diagnostics feature has not detected a system error.

Recovering the BIOS code

If the BIOS code has become damaged, such as from a power failure during a flash update, you can recover the BIOS code using the boot block jumper and a BIOS flash diskette.

Note: You can obtain a BIOS flash diskette from one of the following sources:

- Use the *ServerGuide Setup and Installation* CD to make a BIOS flash diskette.
- Download a BIOS flash diskette from the World Wide Web. Go to <http://www.ibm.com/pc/support>, click **IBM Server Support**, and make the selections for your server.
- Contact your IBM service representative.

The flash memory of your server contains a protected area that cannot be overwritten. The recovery boot block is a section of code in this protected area that enables the server to start up and to read a flash diskette. The flash utility recovers the system BIOS code from the BIOS recovery files on the diskette.

Complete the following steps to recover the BIOS code:

1. Turn off the server, and disconnect all power cords and external cables.
2. Remove the server cover. See “Removing the cover and bezel” on page 48 for more information.

3. Locate the flash boot block recovery jumper block (J34) on the system board.

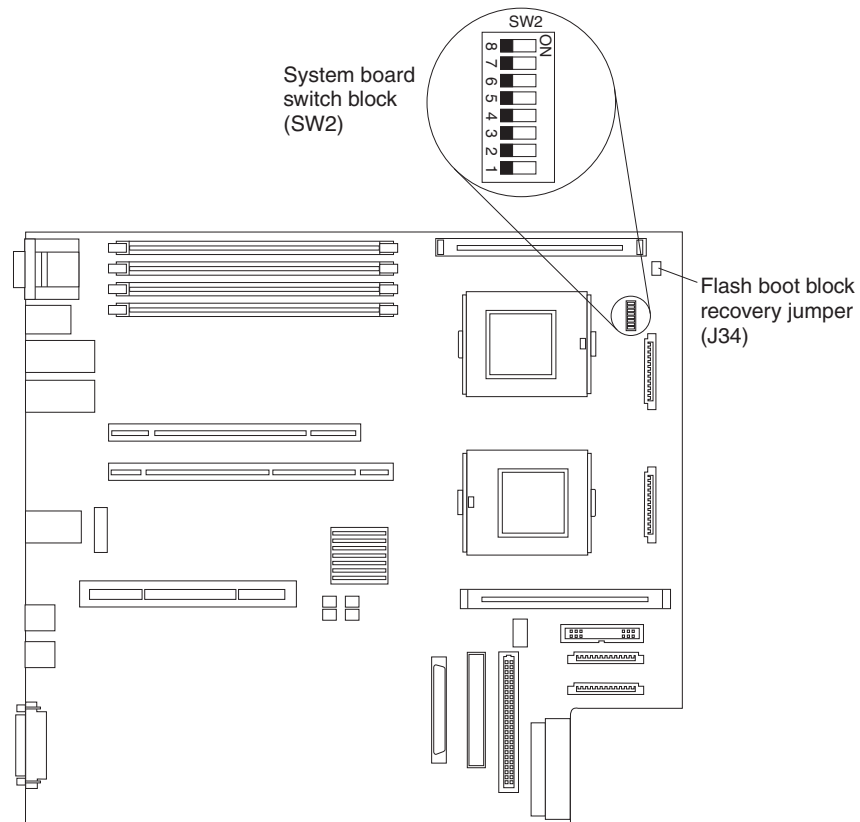

4. Move the jumper from pins 1 and 2 to pins 2 and 3 to enable the BIOS recovery mode.
5. Insert the BIOS flash diskette into the diskette drive.
6. Reinstall the server cover; then, reconnect all power cords.
7. Restart the server. The system begins the power-on self test (POST).
8. Select **1 - Update POST/BIOS** from the menu that contains various flash update options.
9. When prompted as to whether you want to save the current code to a diskette, press **N**.
10. When prompted to choose a language, select a language (from 0 to 7), and press **Enter** to accept your choice.
11. Remove the BIOS flash diskette from the diskette drive.
12. Turn off the server, and disconnect all power cords and external cables; then, remove the server cover.
13. Remove the jumper from the Flash boot block recovery jumper block, or move it to pins 1 and 2 to return to normal startup mode.
14. Reconnect all external cables and power cords, and turn on the peripheral devices; then, reinstall the server cover.
15. Restart the server. The server starts up normally.

Power checkout

Power problems can be difficult to solve. For example, a short circuit can exist anywhere on any of the power distribution buses. Usually, a short circuit will cause the power subsystem to shut down because of an overcurrent condition.

A general procedure for troubleshooting power problems is as follows:

1. Turn off the server, and disconnect all ac power cords.
2. Check for loose cables in the power subsystem. Also check for short circuits, for example, if there is a loose screw causing a short circuit on a circuit board.
3. Remove adapters, and disconnect the cables and power connectors to all internal and external devices until the server is at the minimum configuration required to start the server (see “Minimum operating requirements” on page 110).
4. Reconnect all ac power cords, and turn on the server. If the server starts up successfully, replace adapters and devices one at a time until the problem is isolated. If the server does not start up from the minimal configuration, replace FRUs of minimal configuration one at a time until the problem is isolated.

To use this method, it is important to know the minimum configuration required for a system to start (see page 99). For specific problems, see “Power-supply LED errors” on page 99.

Troubleshooting the Ethernet controller

This section provides troubleshooting information for problems that might occur with the 10/100/1000 Mbps Ethernet controller.

Network connection problems

If the Ethernet controller cannot connect to the network, check the following conditions:

- Make sure that the cable is installed correctly.

The network cable must be securely attached at all connections. If the cable is attached but the problem remains, try a different cable.

If you set the Ethernet controller to operate at either 100 Mbps or 1000 Mbps, you must use Category 5 or higher cabling.

- Determine whether the hub supports auto-negotiation. If it does not, try configuring the integrated Ethernet controller manually to match the speed and duplex mode of the hub.
- Check the Ethernet controller LEDs (on the operator information panel, on the rear of the server, or both, depending on model; see “Server controls and indicators” on page 4).

These LEDs indicate whether a problem exists with the connector, cable, or hub.

- The Ethernet transmit/receive activity LED is lit when the Ethernet controller sends or receives data over the Ethernet network. If the Ethernet transmit/receive activity LED is off, make sure that the hub and network are operating and that the correct device drivers are installed.
- The Ethernet link status LED is lit when the Ethernet controller receives a LINK pulse from the hub. If the LED is off, there might be a defective connector or cable or a problem with the hub.
- Make sure that you are using the correct device drivers, which come with your server.
- Check for operating-system-specific causes for the problem.
- Make sure that the device drivers on the client and server are using the same protocol.
- Test the Ethernet controller.

The way the Ethernet controller is tested depends on which operating system you are using (see the Ethernet controller device driver README files).

Ethernet controller troubleshooting chart

Use the following troubleshooting chart to find solutions to 10/100/1000 Mbps Ethernet controller problems that have definite symptoms.

Table 6. Ethernet troubleshooting chart

Ethernet controller problem	FRU/actions
The server stops running when loading device drivers.	<p>Check the following:</p> <ul style="list-style-type: none"> • Determine if the interrupt (IRQ) setting assigned to the Ethernet controller is also assigned to another device in the Configuration/Setup Utility program. <p>Although interrupt sharing is allowed for PCI devices, some devices do not function well when they share an interrupt with a dissimilar PCI device. Try changing the IRQ assigned to the Ethernet controller or the other device. For example, for NetWare Versions 3 and 4, it is recommended that disk controllers not share interrupts with LAN controllers.</p> <ul style="list-style-type: none"> • Make sure that you are using the most recent device driver available from the World Wide Web. • Run the network diagnostic program. • Reseat or replace the adapter.
Ethernet link status LED is off.	<p>Check the following:</p> <ul style="list-style-type: none"> • Make sure that the hub is turned on. • Check all connections at the Ethernet controller and the hub. • Use another port on the hub. • If the hub does not support auto-negotiation, manually configure the Ethernet controller to match the hub. • If you manually configured the Duplex mode, make sure that you also manually configure the speed. • Run diagnostics on the LEDs. • Reseat or replace the adapter.
The Ethernet transmit/receive activity LED is off.	<p>Check the following:</p> <ul style="list-style-type: none"> • Make sure that you have loaded the network device drivers. • The network might be idle. Try sending data from this server. • Run diagnostics on the LEDs.
Data is incorrect or sporadic.	<p>Check the following:</p> <ul style="list-style-type: none"> • Make sure that you are using Category 5 or higher cabling when operating the server at 100 Mbps or at 1000 Mbps. • Make sure that the cables do not run close to noise-inducing sources like fluorescent lights.
The Ethernet controller stopped working when another adapter was added to the server.	<p>Check the following:</p> <ul style="list-style-type: none"> • Make sure that the cable is connected to the Ethernet controller. • Make sure that your PCI system BIOS code is current. • Reseat the adapter. • Determine if the interrupt (IRQ) setting assigned to the Ethernet adapter is also assigned to another device in the system. Use the Configuration/Setup Utility program to determine if this is the case. <p>Although interrupt sharing is allowed for PCI devices, some devices do not function well when they share an interrupt with a dissimilar PCI device. Try changing the IRQ assigned to the Ethernet adapter or the other device.</p> <ul style="list-style-type: none"> • Reseat or replace the adapter.
The Ethernet controller stopped working without apparent cause.	<p>Check the following:</p> <ul style="list-style-type: none"> • Run diagnostics for the Ethernet controller. • Try a different connector on the hub. • Reinstall the device drivers. See your operating-system documentation and the ServerGuide information. • Reseat or replace the adapter.

Ethernet controller messages

The integrated Ethernet controller might display messages from certain device drivers. The latest information available concerning these messages will be made available at the IBM Support Web site at <http://www.ibm.com/pc/support>.

Chapter 4. Customer replaceable units

This chapter provides instructions for adding options to your server and replacing damaged components. Some option-removal instructions are provided in case you need to remove one option to install another.

Before you begin

Before you begin to install options in your server, read the following information:

- Become familiar with the safety and handling guidelines specified under “Handling static-sensitive devices” on page 42, and read the safety statements in “Safety information” on page 121.
- You do not need to turn off the server to install or replace hot-swap power supplies, hot-swap drives, hot-swap fans, Active™ PCI (hot-plug) adapters, or hot-plug Universal Serial Bus (USB) devices (if these devices are supported).
- The orange color on components and labels in your server identifies hot-swap or hot-plug components. You can install or remove hot-swap and hot-plug components while the server is running, provided that your server is configured to support this function. For complete details about installing or removing a hot-swap or hot-plug component, see the detailed information in this chapter.
- The blue color on components and labels identifies touch points where you can grip a component, move a latch, and so on.
- Make sure that you have an adequate number of properly grounded electrical outlets for your server, monitor, and any other options that you intend to install.
- Back up all important data before you make changes to disk drives.
- For a list of supported options for your server, go to <http://www.ibm.com/pc/us/compat/> on the World Wide Web.

System reliability considerations

To help ensure proper cooling and system reliability, make sure that:

- Each of the drive bays has either a drive or a filler panel installed.
- Each of the power-supply bays has a power supply or a power supply filler panel installed.
- Do not leave open space above or below an installed server in your rack cabinet. To help prevent damage to server components, always install a blank filler panel to cover the open space and to help ensure proper air circulation. See the documentation that comes with the rack for additional information.
- The server cover is in place during normal operation.
- The air-baffle cover over the microprocessors remains closed during normal operation.
- The air baffle is installed between the fans and the power supply.
- A removed hot-swap drive is replaced within 2 minutes of removal.
- Cables for optional adapters are routed according to the instructions provided with the adapters.
- A failed fan is replaced within 48 hours.
- The server is turned off and the power cords are disconnected before you open the air-baffle cover.
- The air-baffle assembly is always installed in the server except when you are installing or removing the components that are located under the air-baffle cover.

- When the air-baffle assembly is installed in the server, the air-baffle cover is always closed.
- Microprocessor socket 2 always contains either a microprocessor baffle or a microprocessor.

Working inside the server with the power on

Your server supports hot-plug, hot-add, and hot-swap devices and is designed to operate safely while turned on with the cover removed. Follow these guidelines when you work inside a server that is turned on:

- Avoid loose-fitting clothing on your forearms. Button long-sleeved shirts before working inside the server; do not wear cuff links while you are working inside the server.
- Do not allow your necktie or scarf to hang inside the server.
- Remove jewelry, such as bracelets, necklaces, rings, and loose-fitting wrist watches.
- Remove items from your shirt pocket (such as pens or pencils) that could fall into the server as you lean over it.
- Avoid dropping any metallic objects, such as paper clips, hair pins, or screws, into the server.

Handling static-sensitive devices

Attention: Static electricity can damage electronic devices and your server. To avoid damage, keep static-sensitive devices in their static-protective packages until you are ready to install them.

To reduce the possibility of electrostatic discharge, observe the following precautions:

- Limit your movement. Movement can cause static electricity to build up around you.
- Handle the device carefully, holding it by its edges or its frame.
- Do not touch solder joints, pins, or exposed printed circuitry.
- Do not leave the device where others can handle and possibly damage the device.
- While the device is still in its static-protective package, touch it to an unpainted metal part of the server for at least 2 seconds. (This drains static electricity from the package and from your body.)
- Remove the device from its package, and install it directly into the server without setting it down. If it is necessary to set the device down, place it in its static-protective package. Do not place the device on the server cover or on a metal table.
- Take additional care when handling devices during cold weather because heating reduces indoor humidity and increases static electricity.

Major components of the xSeries 345 Type 8670 server

The following illustration shows the major components in your server.

Note: The illustrations in this document might differ slightly from your hardware.

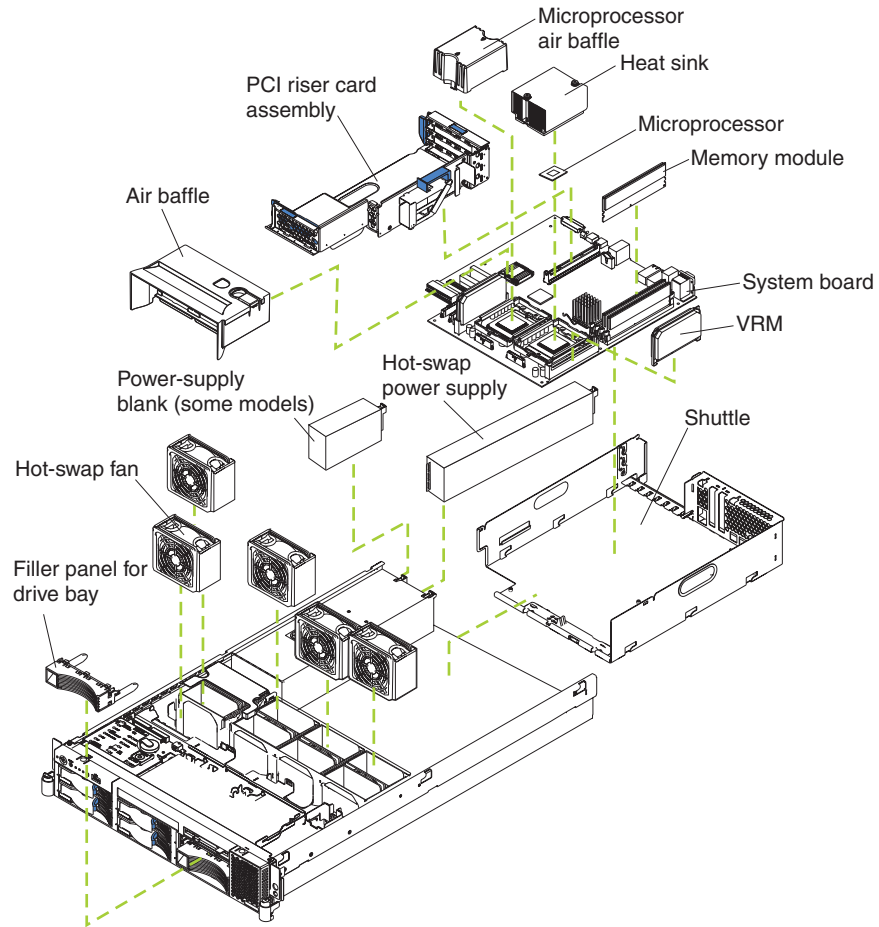

Component locations

This section provides illustrations of the system-board and PCI riser-card component locations.

System-board option connectors

The following illustration shows the location of the system-board connectors for user-installable options.

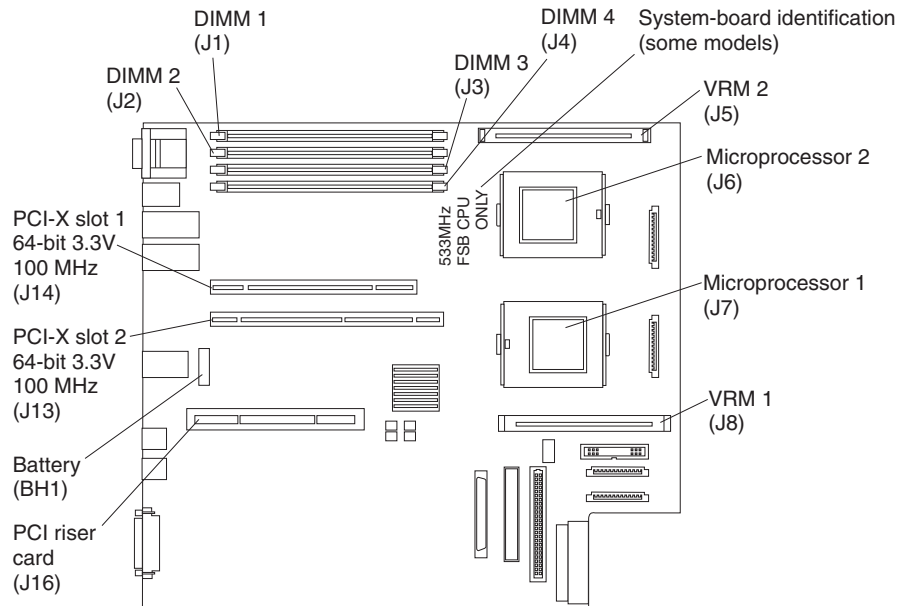

PCI riser-card option connectors

The following illustration shows the location of the PCI riser-card connectors for user-installable options.

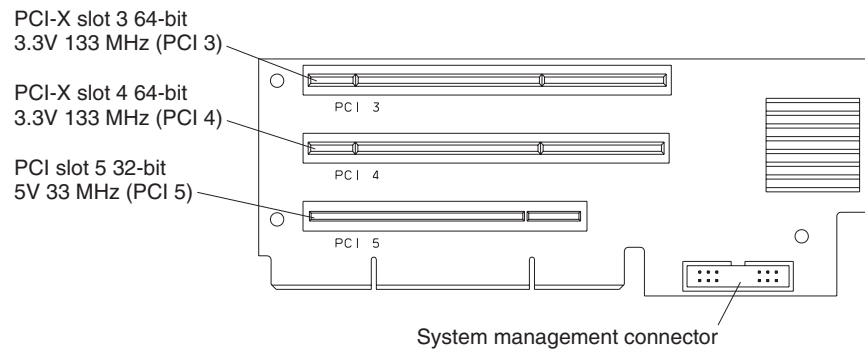

System-board internal cable connectors

The following illustration shows the internal cable connectors on the system board.

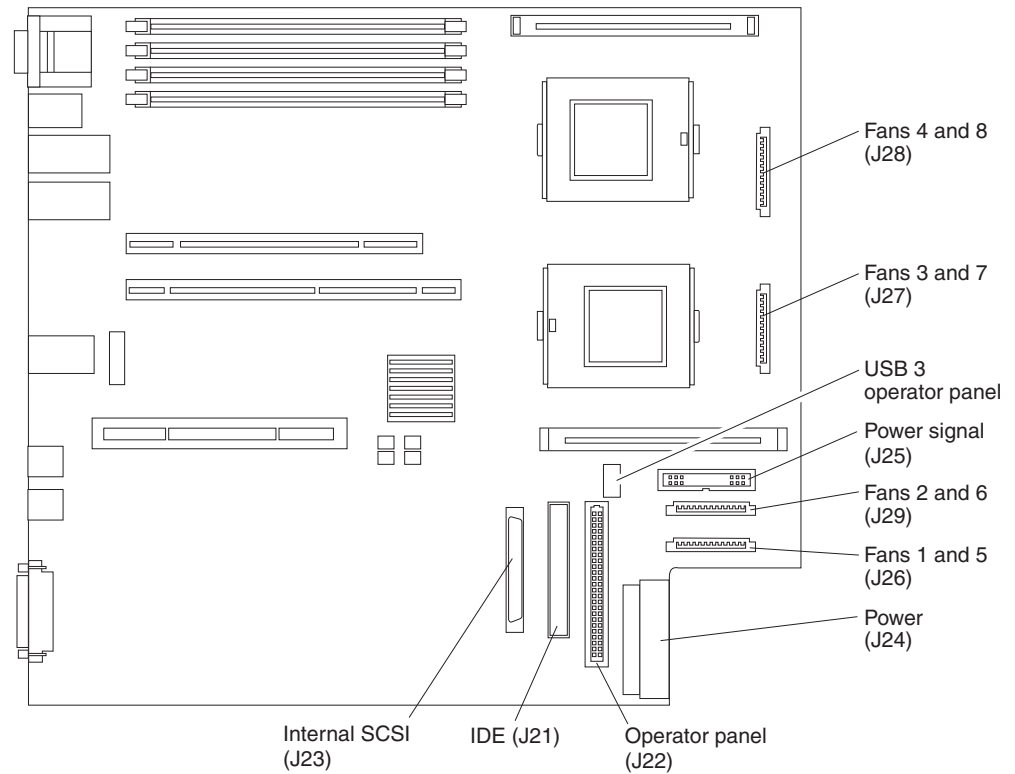

System-board external port connectors

The following illustration shows the location of the input/output external port connectors on the system board.

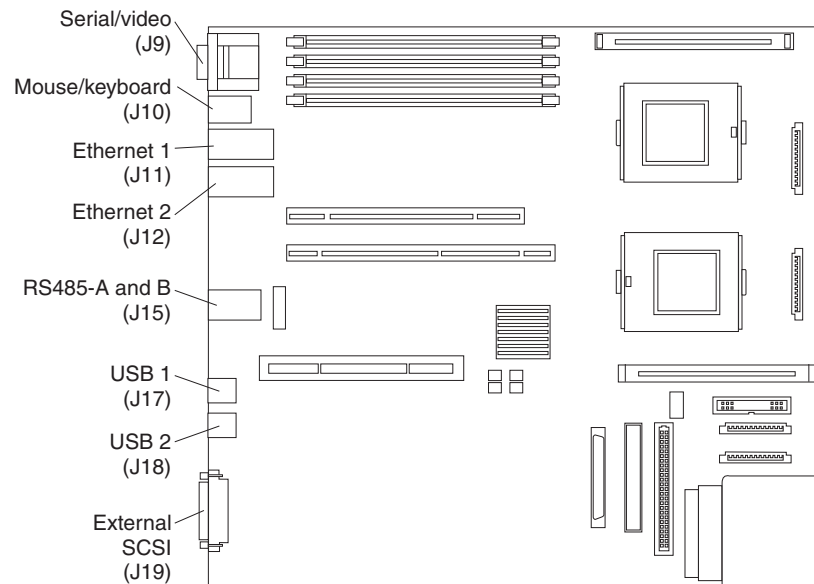

System-board switches and jumpers

The following illustration shows the location of the switch block (SW2) on the system board.

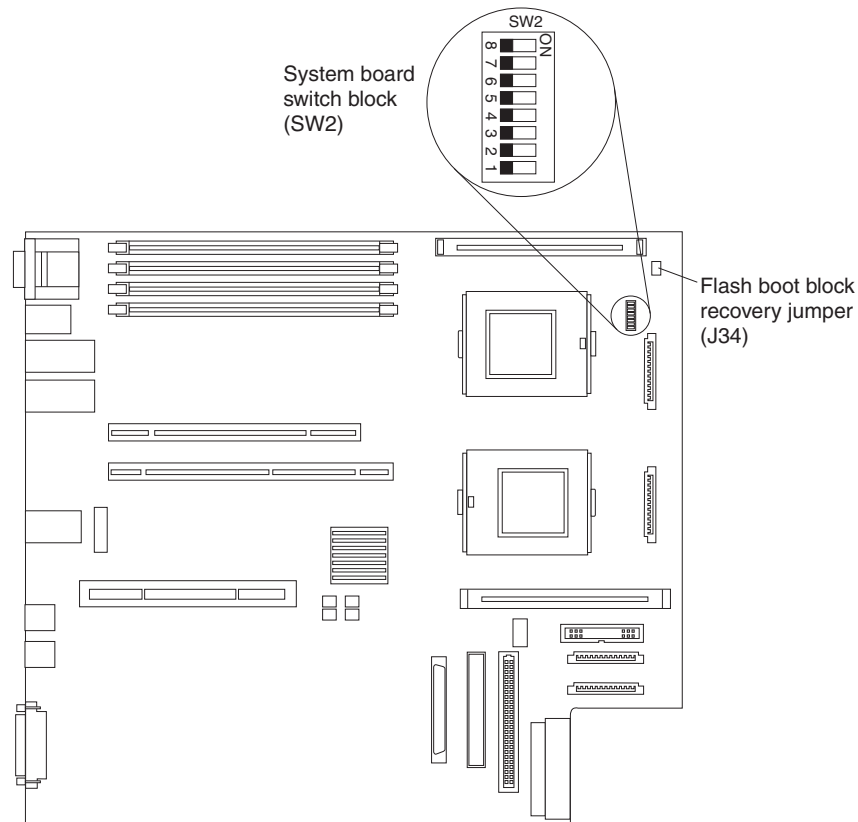

The following table describes the function for each switch on the switch block.

Switch number	Default value	Switch description
8	Off	Reserved.
7	Off	Reserved.
6	Off	Reserved.
5	Off	Reserved.
4	Off	Reserved.
3	Off	Power-on override. When toggled to On, this switch forces the power on, overriding the power-on button.
2	Off	Power-on password override. Changing the position of this switch bypasses the power-on password check the next time the server is turned on and starts the Configuration/Setup Utility program so that you can change or delete the power-on password. You do not need to move the switch back to the default position after the password is overridden. Changing the position of this switch does not affect the administrator password check if an administrator password is set. See Chapter 2, "Configuring your server," on page 9 for additional information about the power-on password.
1	Off	H8 out serial port. This switch is reserved for service use only.

Notes:

1. Before changing any switch settings or moving any jumpers, turn off the server; then, disconnect all power cords and external cables.
2. Any system-board switch or jumper blocks that are not shown in the illustrations in this book are reserved.

System-board LED locations

The following illustration shows the location of the LEDs on the system board. You might need to refer to this illustration when solving problems with the server.

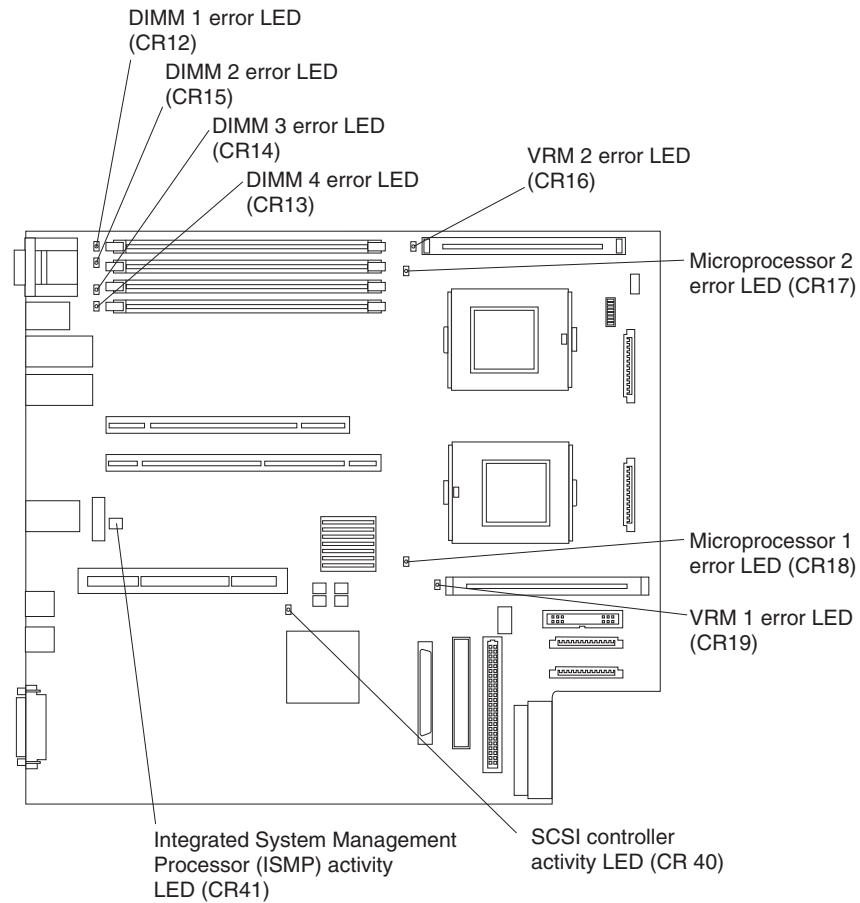

Removing the cover and bezel

The following illustration shows how to remove the cover and bezel.

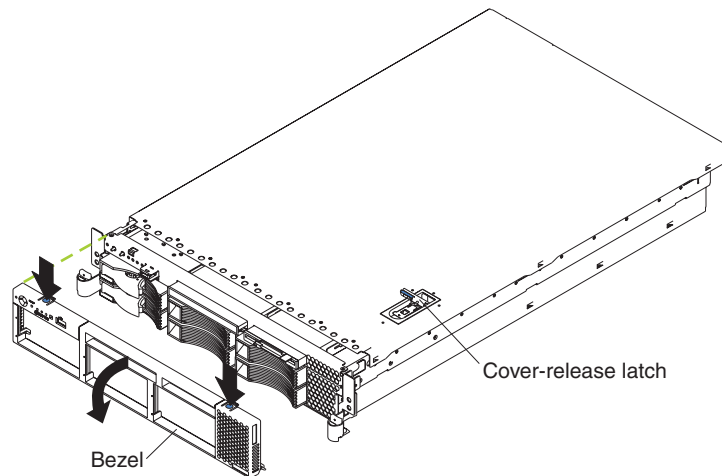

Complete the following steps to remove the server top cover:

1. Read the safety information beginning on page 121 and “System reliability considerations” on page 41.
2. If you are planning to install or remove a microprocessor, memory-module, PCI adapter, or battery, turn off the server and all attached devices, and disconnect all external cables and power cords (see “Turning off the server” on page 6).
3. Press down on the left and right side latches and pull the server out of the rack enclosure until both slide rails lock.

Note: You can reach the cables on the back of the server when the server is in the locked position.

4. Lift the cover-release latch. Lift the cover off the server and set the cover aside.

Attention: For proper cooling and airflow, replace the cover before turning on the server. Operating the server for extended periods of time (over 30 minutes) with the cover removed might damage server components.

Complete the following steps to remove the bezel:

1. Press in on the tabs on the top of the bezel, and rotate the bezel away from the server front.
2. Store the bezel in a safe place.

Working with adapters

The following notes describe the types of adapters that your server supports and other information that you must consider when installing adapters:

Before you install an adapter, review the following information:

- Read the documentation that comes with your operating system.
- Locate the documentation that comes with the adapter and follow those instructions in addition to the instructions in this chapter. If you need to change the switch or jumper settings on your adapter, follow the instructions that come with the adapter.
- You can install only low-profile adapters in slots 1 and 2.

- You can install standard full-length adapters, with the adapter guides removed from the adapters, in slots 3 and 4.
- You can install only a half-length adapter in slot 5.
- A ServeRAID-5i adapter can be installed only in PCI slot 2. The low-profile 2-U bracket that comes with the controller is required to install the controller.
- The optional IBM Remote Supervisor Adapter can be installed only in PCI slot 5. Use the ribbon cable that comes with the adapter to connect the adapter to the system management connector on the PCI riser card.
- Your server supports 5.0 V and universal PCI adapters on the 32-bit PCI slot 5; your server supports only 3.3 V and universal PCI adapters in the 64-bit PCI/PCI-X slot 3 and 4.
- The PCI bus configuration is:
 - Non-hot-plug, 64-bit PCI-X slots 1 and 2 (PCI bus A, 100 MHz)
 - Non-hot-plug, 64-bit PCI-X slots 3 and 4 (PCI bus B, 133 MHz)
 - Non-hot-plug, 32-bit PCI slot 5 (PCI bus C, 33 MHz)
- The server scans PCI and PCI-X slots 1 through 5 to assign system resources. Then, the server starts (boots) the system devices in the following order, if you have not changed the default boot precedence: integrated Ethernet controller, integrated SCSI controller, and then PCI and PCI-X slots 5, 3, 4, 1, and 2.

Notes:

1. If a ServeRAID-5i adapter is installed, it takes control of the integrated SCSI controller with RAID capabilities and operates at 66 MHz. A ServeRAID-5i adapter can be installed only in slot 2.
2. To have SCSI capabilities if you remove the ServeRAID-5i adapter or other RAID adapter, start the Configuration/Setup Utility program, and select **Devices and I/O Ports** from the main menu to enable the SCSI controller with RAID capabilities. See “Using the Configuration/Setup Utility program” on page 11 for details about using the Configuration/Setup Utility program.
3. To change the startup (boot) precedence for PCI and PCI-X devices, start the Configuration/Setup Utility program, and select **Start Options** from the main menu. See “Using the Configuration/Setup Utility program” on page 11 for details about using the Configuration/Setup Utility program.

The following illustrations show the location of the PCI and PCI-X adapter expansion slots on the system board and PCI riser card.

System board

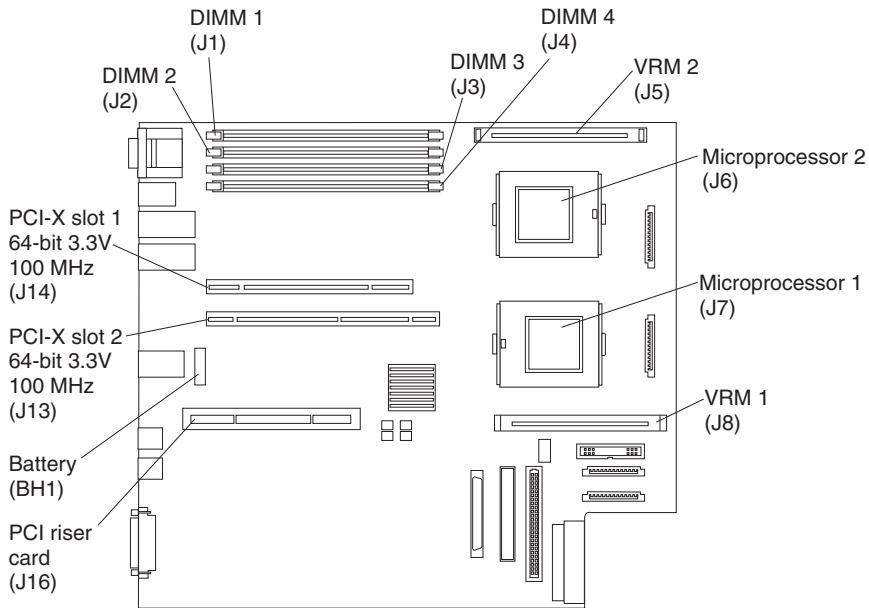

PCI riser card

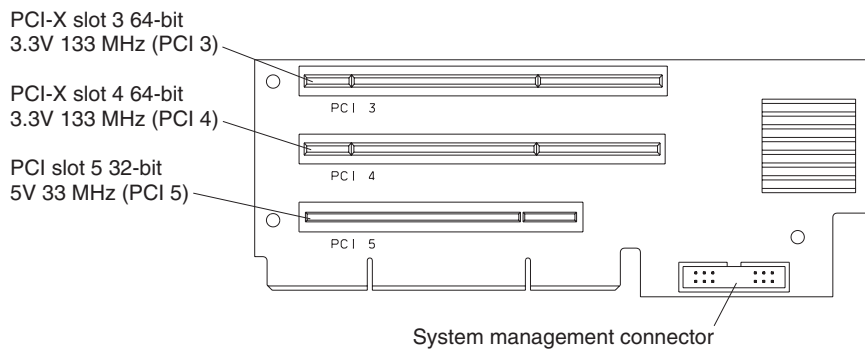

Complete the following steps to install a PCI or PCI-X adapter:

1. Read the safety information beginning on page 121 and “System reliability considerations” on page 41.
2. Turn off the server and peripheral devices, and disconnect all power cords and external cables (see “Turning off the server” on page 6); then, remove the cover (see “Removing the cover and bezel” on page 48).
3. Determine which expansion slot you will use for the adapter.

4. If you are installing an adapter in PCI slot 3, 4, or 5, remove the PCI riser-card assembly.
 - a. Lift the retention latch to release the PCI riser-card assembly.
 - b. Lift the assembly from the server.
 - c. Place the assembly on a flat, level surface.

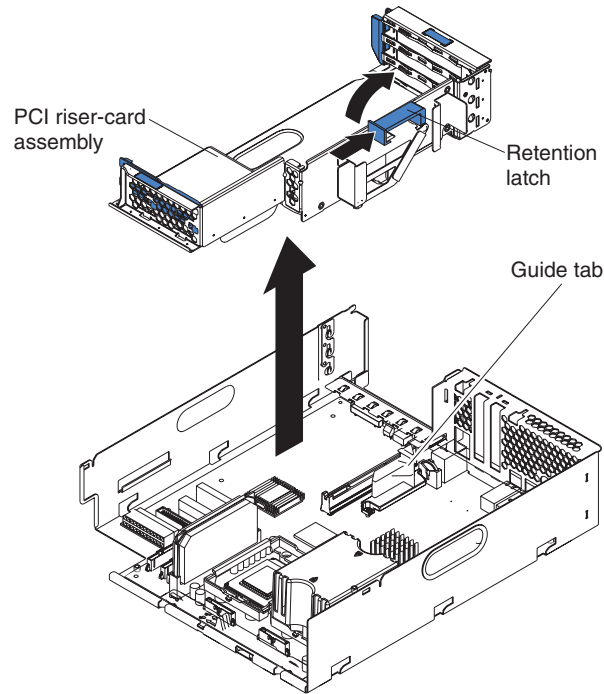

5. Open the adapter retainer, and slide the expansion-slot cover out of the server or PCI riser-card assembly. Store it in a safe place for future use.

Attention: Expansion-slot covers must be installed on all empty slots. This maintains the electronic emissions characteristics of the system and ensures proper cooling of system components.
6. See the documentation that comes with your adapter for any cabling instructions. It might be easier for you to route cables before you install the adapter.
7. Remove the adapter from the static-protective package.

Attention: Avoid touching the components and gold-edge connectors on the adapter.

8. Install the adapter:
 - a. If you are installing a full-length adapter, remove the blue adapter guide (if any) from the end of the adapter.

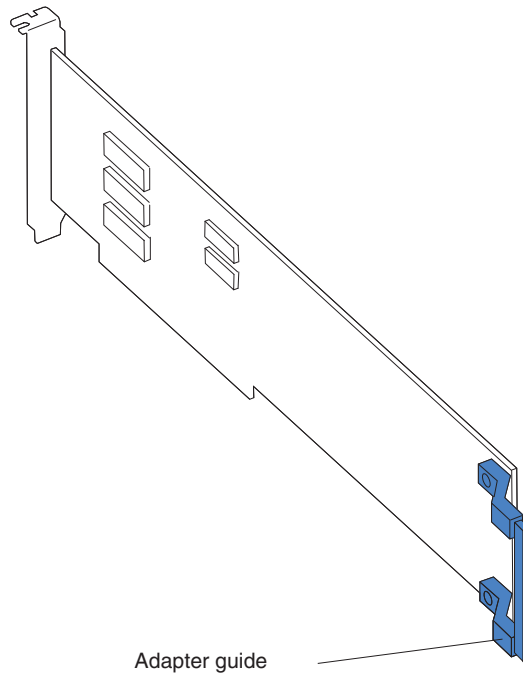

- b. Carefully grasp the adapter by its top edge or upper corners, and align it with the expansion slot.
- c. Press the adapter *firmly* into the expansion slot, and close the adapter retainer.

Attention: When you install an adapter in the server, be sure that it is completely and correctly seated in the connector. Incomplete insertion might cause damage to the system board or the adapter.

The following illustration shows how to install a PCI or PCI-X adapter in slots 1 and 2.

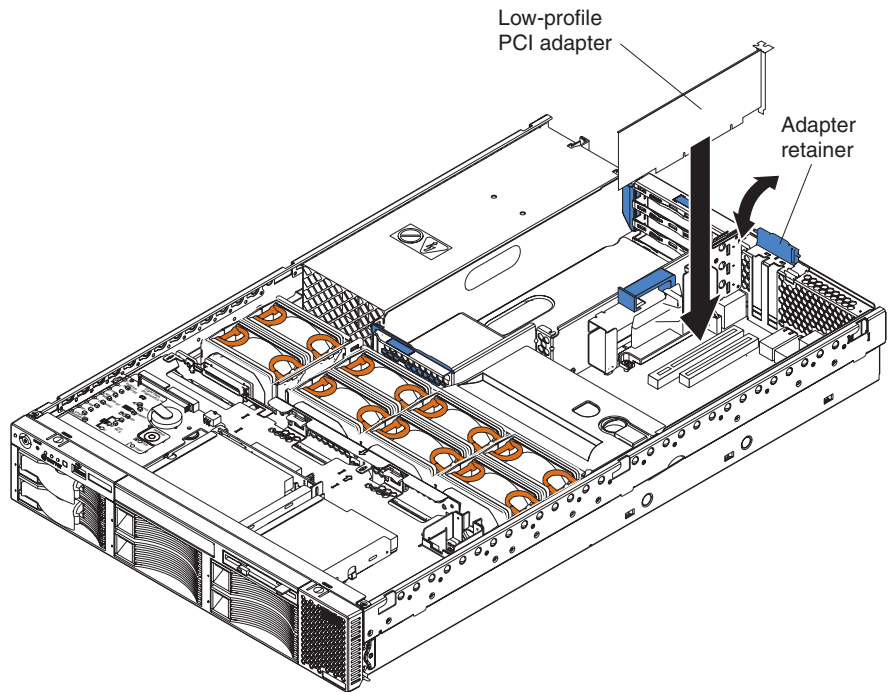

The following illustration shows how to install a PCI or PCI-X adapter in slots 3, 4, and 5.

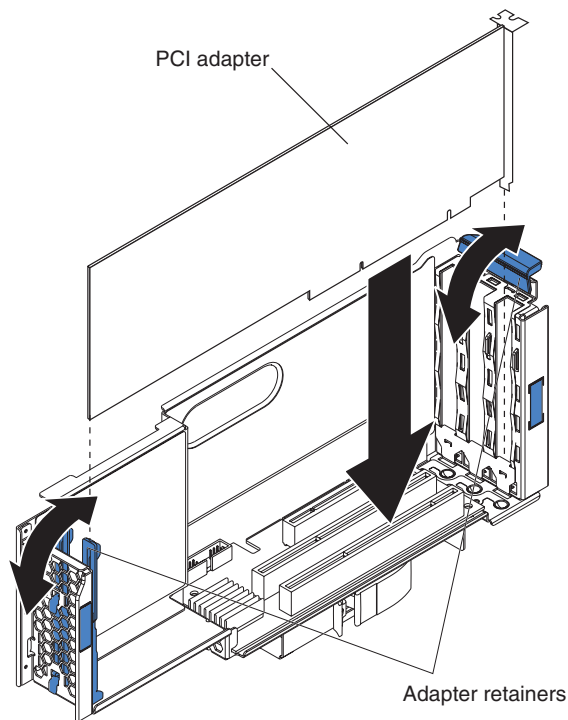

9. If you removed the PCI riser-card assembly to install the adapter, press the PCI riser-card assembly *firmly* into the connector, and close the retention latch.

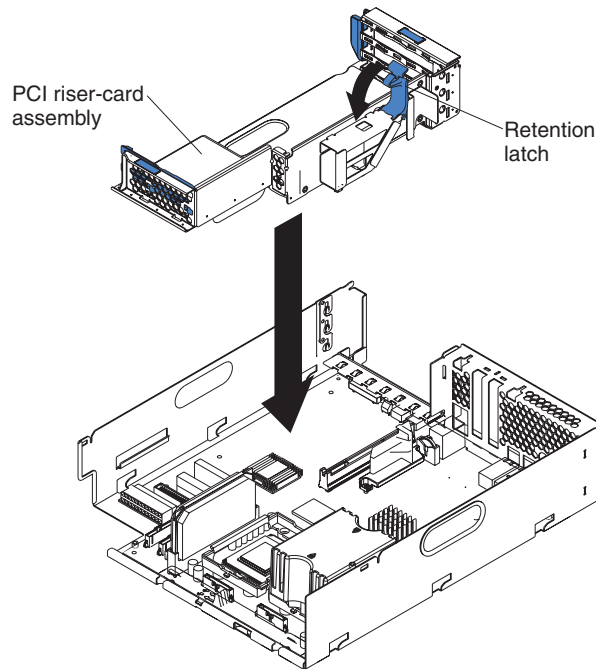

Note: Make sure that the PCI riser-card assembly is properly seated on the system-board connector and that the cables under the PCI riser-card assembly are not pinched.

10. Connect any needed cables to the adapter. See the documentation that comes with your adapter for cabling instructions.

Attention:

- When you route the cables, do not block the ventilated space around any of the fans. In addition, route any cables that are plugged into the PCI adapter under adjacent adapters so they are not pinched between the top edge of the adapter and the shuttle side wall.
- To ensure system reliability, an optional SCSI adapter cannot control internal hard disk drives.

If you have other options to install or remove, do so now. Otherwise, go to “Installing the server cover and bezel” on page 70.

Installing a ServeRAID-5i adapter

The following notes describe the ServeRAID-5i adapter and other information that you must consider when installing the ServeRAID-5i controller:

- You can install an optional RAID adapter in your server to control the internal hot-swap hard disk drives, for example, to enable you to configure the internal hot-swap hard disk drives into disk arrays. You can also cable a RAID adapter to external hard disk drives. See your RAID adapter option documentation for complete instructions to install a RAID adapter in your server and for additional information about RAID controllers.
- No rerouting of the internal SCSI cable is required if you are installing the ServeRAID-5i adapter. The ServeRAID-5i adapter uses the SCSI connector on the system board for output.

- The ServeRAID-5i adapter can be installed only in PCI-X slot 2. Slot 2 is the only PCI-X slot that supports the ServeRAID-5i adapter requirements.
- Connections made to external SCSI devices will be asynchronous.
- To have SCSI capabilities if you remove the ServeRAID-5i adapter or other RAID adapter, start the Configuration/Setup Utility program, and select **Devices and I/O Ports** from the main menu to enable the SCSI controller with RAID capabilities. See “Using the Configuration/Setup Utility program” on page 11 for details about using the Configuration/Setup Utility program.

Complete the following steps to install a ServeRAID-5i controller:

1. Read the safety information beginning on page 121 and “System reliability considerations” on page 41.
2. Turn off the server and peripheral devices, and disconnect all power cords and external cables (see “Turning off the server” on page 6); then, remove the cover (see “Removing the cover and bezel” on page 48).
3. Open the adapter retainer, and slide the slot 2 expansion-slot cover out of the server. Store it in a safe place for future use.

Attention: Expansion-slot covers must be installed on all empty slots. This maintains the electronic emissions characteristics of the system and ensures proper cooling of system components.

4. Install the low-profile 2-U bracket on the adapter:
 - a. Remove the adapter from the static-protective package. Set the adapter down on a nonconductive, static-protected surface (place it component side up).
5. Install the adapter:
 - a. Carefully grasp the adapter by its top edge or upper corners, and align it with the expansion slot on the system board.
 - b. Press the adapter *firmly* into the expansion slot, and close the adapter retainer.

Attention: Avoid touching the components and gold-edge connectors on the adapter.

Attention: Remove the 3-U bracket from the adapter, and replace it with the 2-U low profile bracket that comes with the RAID adapter option. See the documentation that comes with your RAID adapter option for instructions.

Attention: When you install an adapter in the server, be sure that it is completely and correctly seated in the connector. Incomplete insertion might cause damage to the system board or the adapter.

If you have other options to install or remove, do so now. Otherwise, go to “Installing the server cover and bezel” on page 70.

Installing a hot-swap drive

The following notes describe the type of hard disk drive that your server supports and other information that you must consider when installing a hard disk drive:

- Your server supports six 1-inch (26 mm) slim 3.5-inch low-voltage differential (LVD) hard disk drives.
- All hot-swap drives installed in the server should have the same throughput speed rating. Mixing hard disk drives with different speed ratings will cause all drives to operate at the lower throughput speed.
- The SCSI ID assigned to each bay is printed on the bezel.

Complete the following steps to install a drive in a hot-swap bay.

Attention: To maintain proper system cooling, do not operate the server for more than 10 minutes without either a drive or a filler panel installed in each bay.

1. Read the safety information beginning on page 121 and “System reliability considerations” on page 41.
2. Remove the filler panel from one of the empty hot-swap bays by inserting your finger into the depression at the left side of the filler panel and pulling it away from the server.
3. Install the hard disk drive in the hot-swap bay:
 - a. Ensure that the tray handle is open (that is, perpendicular to the drive).
 - b. Align the drive assembly with the guide rails in the bay.
 - c. Gently push the drive assembly into the bay until the drive stops.
 - d. Push the tray handle to the closed (locked) position.

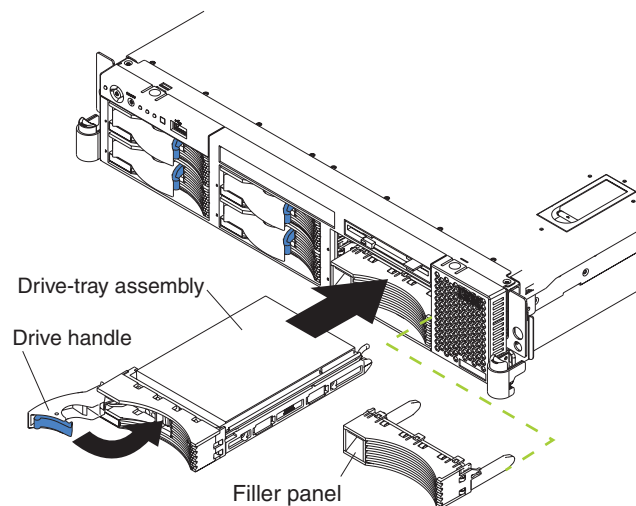

- e. Check the hard disk drive status LED to verify that the hard disk drive is operating properly.

If the amber hard disk drive status LED for a drive is lit continuously, that individual drive is damaged and needs to be replaced. If the green hard disk drive activity LED is flashing, the drive is being accessed.

Note: If you have a RAID configuration on your server using the integrated SCSI controller with RAID capabilities, or if your server has a RAID adapter installed, you might need to reconfigure your disk arrays after installing hard disk drives. See the RAID documentation on the IBM *xSeries Documentation* CD for information about RAID adapters.

Installing memory modules

The following notes describe the types of dual inline memory modules (DIMMs) that your server supports and other information that you must consider when installing DIMMs:

- The system board contains four DIMM connectors and supports two-way memory interleaving.
- The DIMM options available for your server are 256 MB, 512 MB, 1 GB, and 2 GB.

- The amount of usable memory will be reduced depending on the system configuration. The BIOS will display the total amount of installed memory and the amount of configured memory.
- Your server supports a minimum of two 256 MB DIMMs (for a total of 512 MB) installed in the DIMM 1 and DIMM 2 memory connectors (J1 and J2, respectively). When you install additional DIMMs, install them in pairs, with the next pair in DIMM connectors 3 and 4 (J3 and J4).
- Both DIMMs in a pair must be the same size, speed, type, and technology. You can mix compatible DIMMs from various manufacturers.
- The second pair of DIMMs do not have to be the same size, speed, type, and technology as the first pair.
- Install only 2.5 V, 184-pin, double-data-rate (DDR), PC2100, registered synchronous dynamic random-access memory (SDRAM) with error correcting code (ECC) DIMMs. These DIMMs must be compatible with the latest PC2100 (and downward compatible with PC1600) SDRAM Registered DIMM specification, which is available from <http://www.jedec.org/> on the World Wide Web. For a list of supported options for your server, go to <http://www.ibm.com/us/compat/> on the World Wide Web.
- Your server supports Chipkill™ technology if the DIMMs are all of the type 4x.
- Save new configuration information only if you replace a damaged DIMM that was marked as **Disabled** in the Configuration/Setup Utility program **Memory Settings** menu. In this case, re-enable the memory row in the Configuration/Setup Utility program or reload the default memory settings. See “Using the Configuration/Setup Utility program” on page 11 for more information.
- Before you begin, read the documentation that comes with your option.
- Install the DIMMs in the order shown in the following table:

Table 7. DIMM order of installation

Pair	DIMM connectors
First	1 and 2 (J1, J2)
Second	3 and 4 (J3, J4)

Complete the following steps to install a DIMM:

1. Read the safety information beginning on page 121 and “System reliability considerations” on page 41.
2. Turn off the server, and disconnect all power cords and external cables (see “Turning off the server” on page 6); then, remove the server cover (see “Removing the cover and bezel” on page 48).
3. Locate the DIMM connectors on the system board, and determine the connectors into which you will install the DIMMs.
4. Touch the static-protective package that contains the DIMM option to any unpainted metal surface on the server. Then, remove the DIMM from the package.

5. To install the DIMM, repeat the following steps for each DIMM that you install:
 - a. Turn the DIMM so that the DIMM keys align correctly with the connector on the system board.

Attention: To avoid breaking the retaining clips or damaging the DIMM connectors, handle the clips gently.
 - b. If closed, open the retaining clips; then, insert the DIMM by pressing the DIMM straight into the connector. Be sure that the retaining clips snap into the closed position.

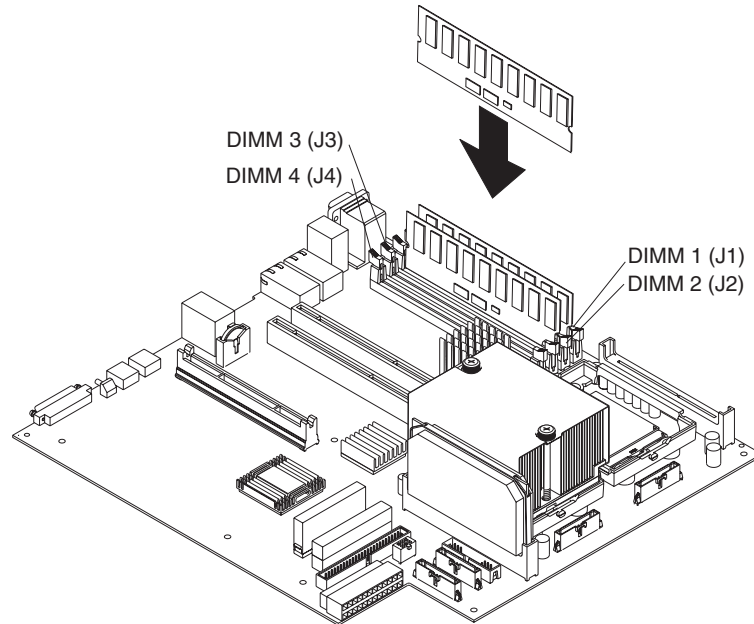

Note: If a gap exists between the DIMM and the retaining clips, the DIMM has not been properly installed. In this case, open the retaining clips and remove the DIMM; then, reinsert the DIMM.

If you have other options to install or remove, do so now. Otherwise, go to “Installing the server cover and bezel” on page 70.

Installing a microprocessor

The following notes describe the type of microprocessor that your server supports and other information that you must consider when installing a microprocessor:

- Your server supports up to two microprocessors. With two microprocessors, your server can operate as a symmetric multiprocessing (SMP) server. With SMP, certain operating systems and application programs can distribute the processing load between the microprocessors. If your server comes with one microprocessor, you can install a second microprocessor.
- You might need to update the server BIOS code. Be sure to read the documentation that comes with the microprocessor so that you can determine whether you need to update the server BIOS code. You can download the latest level of BIOS code and many other code updates for your server at <http://www.ibm.com/pc/support/> on the World Wide Web.
- (Optional) Obtain an SMP-capable operating system. For a list of supported operating systems and other options, go to <http://www.ibm.com/pc/us/compat/> on the World Wide Web.

- To order additional microprocessor options, contact your IBM reseller or IBM marketing representative.
- When you install the microprocessor in socket J6, you must also install the voltage regulator module (VRM) that comes with the microprocessor in VRM connector J5.
- The microprocessor speeds are automatically set for this server; therefore, you do not need to set any microprocessor frequency-selection jumpers or switches.
- If you need to replace a microprocessor, call for service.
- If your server supports a 400 MHz front-side bus, install only a microprocessor with one pin missing from one corner and two pins missing from an adjacent corner. If your server supports a 400 MHz front-side bus, the heat-sink retention mechanism surrounding the microprocessor connector is metallic gray.

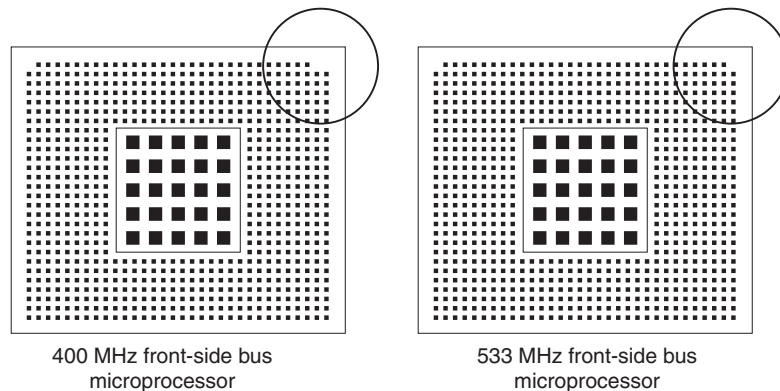

If your server supports a 533 MHz front-side bus, install only a microprocessor with one pin missing from each of two adjacent corners. If your server supports a 533 MHz front-side bus, the heat-sink retention mechanism surrounding the microprocessor connector is black.

- If the thermal-grease protective cover (for example, a plastic cap or tape liner) is removed from the heat sink or fan sink, do not touch the thermal grease on the bottom of the heat sink or fan sink or set down the heat sink or fan sink.

Note: Removing the heat sink or fan sink from the microprocessor destroys the even distribution of the thermal grease and requires replacing the thermal grease. Setting down the heat sink or fan sink onto any surface when the thermal-grease protective cover is removed will contaminate the thermal grease. If the thermal grease becomes contaminated with particles, it must be replaced.

For information about replacing contaminated thermal grease on the heat sink or fan sink, contact IBM Integrated Technology Services. For the most up-to-date phone numbers, go to <http://www.ibm.com/planetwide/>, or in the U.S. and Canada, call 1-800-IBM-SERV (1-800-426-7378).

Have the following information ready when you call:

- Machine type and model
- Serial number of your server
- Do not remove the first microprocessor from the system board to install the second microprocessor.

The following illustration is a simplified layout of the microprocessor connector locations and other microprocessor-related components on the system board.

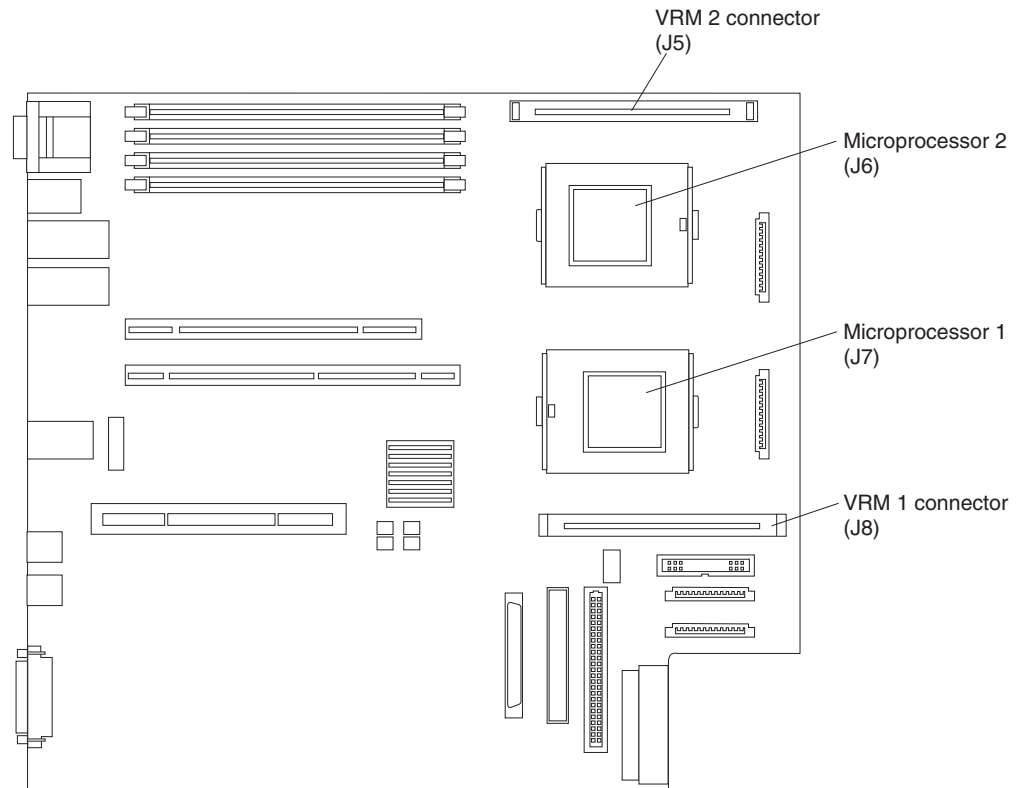

Note: For additional illustrations of the system-board components, see “System-board option connectors” on page 44

Attention:

- A startup (boot) processor must always be installed in socket J7 on the system board.
- To ensure proper server operation when you install an additional microprocessor, use microprocessors that have the same cache size and type, and the same clock speed. Microprocessor internal and external clock frequencies must be identical.

Complete the following steps to install an additional microprocessor:

1. Read the safety information beginning on page 121 and “System reliability considerations” on page 41.
2. Turn off the server, and disconnect all power cords and external cables (see “Turning off the server” on page 6); then, remove the server cover (see “Removing the cover and bezel” on page 48).
3. Remove the air baffle covering the microprocessor section of the system board, and set the air baffle aside.
4. Remove the air baffle from the empty microprocessor socket. Store it in a safe place for future use. An empty microprocessor socket must contain an air baffle.

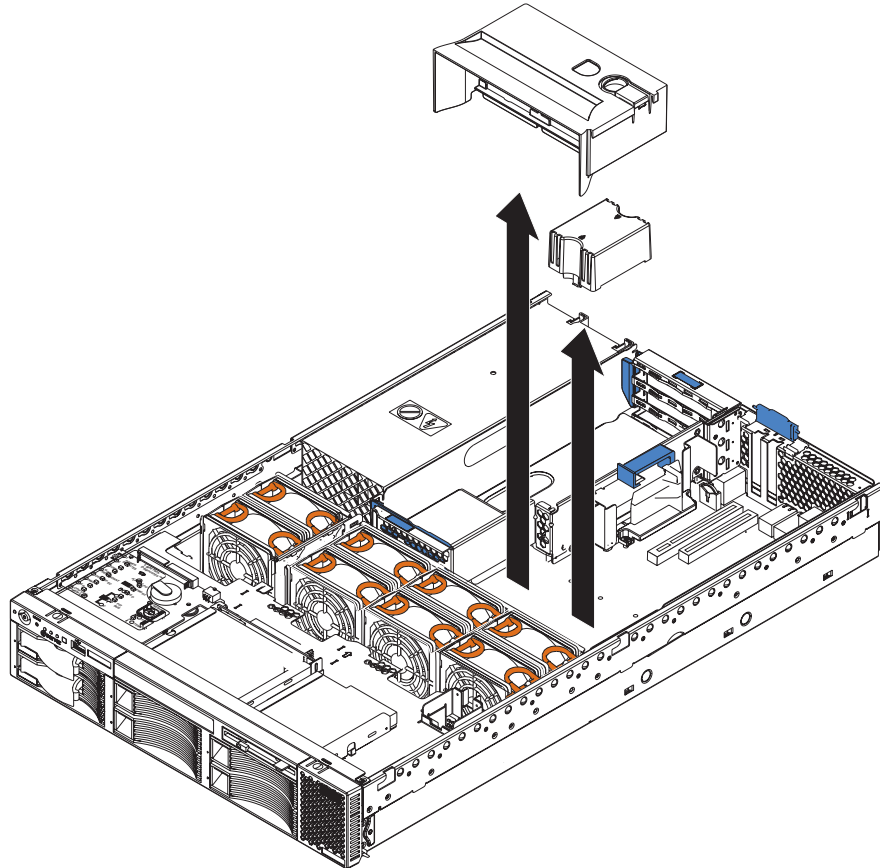

5. Install a VRM in the VRM connector (J5). See the illustration at the beginning of these instructions for the location of the connectors:
 - a. Center the VRM over the connector. Make sure that the VRM is oriented and aligned correctly.
 - b. Carefully but firmly push down the VRM to seat the VRM in the connector.
 - c. Insert one end of the retainer clip on the side of the connector, and fit the retainer clip over the VRM. Insert the free end of the retainer clip on the other side of the connector.

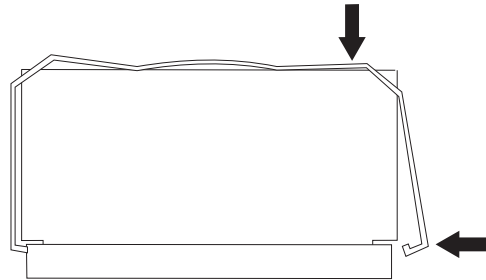

6. Locate the second microprocessor socket (connector J6) on the system board.
7. Install the microprocessor:

- a. Touch the static-protective package containing the microprocessor to any unpainted metal surface on the server. Then, remove the microprocessor from the package.
- b. Remove the protective cover, tape, or label from the surface of the microprocessor socket, if present.

Attention: You must ensure that the locking lever on the microprocessor socket is in the fully open position before you insert the microprocessor in the socket. Failure to do so might result in permanent damage to the microprocessor, microprocessor socket, and system board.

- c. Rotate the locking lever on the microprocessor socket from its closed and locked position until it stops or clicks in the fully open position (approximately 135° angle).

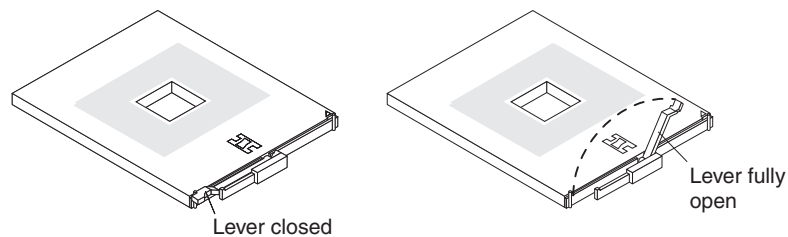

Attention:

- Do not use excessive force when pressing the microprocessor into the socket.
- Make sure that the microprocessor is oriented and aligned correctly with pin number 1 in the socket before you try to close the lever.

- d. Center the microprocessor over the microprocessor socket. Align the triangle on the corner of the microprocessor with the triangle on the corner of the socket, and carefully press the microprocessor into the socket.

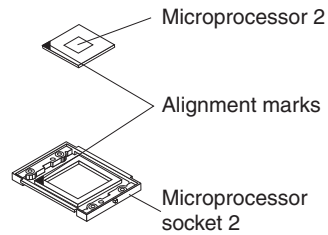

- e. Carefully close the microprocessor-release lever to secure the microprocessor in the socket.
8. Install a heat sink on the microprocessor:

Attention:

- Do not set the heat sink down after you remove the plastic cover.

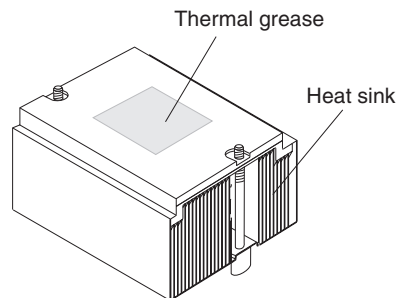

- Do not touch the thermal grease on the bottom of the heat sink or set down the heat sink. Any contact with the thermal grease will contaminate it. For details, see the thermal grease information on page 59.

- a. Remove the plastic protective cover from the bottom of the heat sink.
- b. Align and place the heat sink on top of the microprocessor with the thermal grease side down. Press firmly on the heat sink.

Attention: If you do not alternate the tightening of the two captive screws, you might damage the microprocessor. Ensure that the screws are completely tightened; otherwise, the server will not function properly.

- c. Alternate the tightening of the captive screws to secure the heat sink to the microprocessor. Turn one screw a few turns and then turn the other screw a few turns, alternating between the screws until the heat sink is secure.

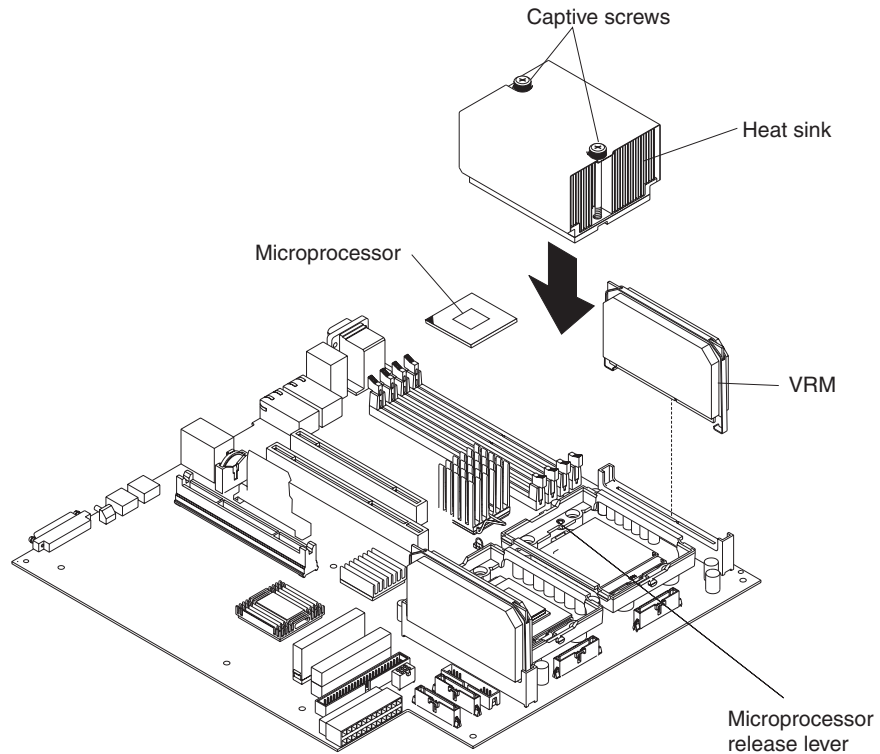

9. Install the air baffle over the microprocessor section of the system board.

If you have other options to install or remove, do so now. Otherwise, go to “Installing the server cover and bezel” on page 70.

Installing a hot-swap power-supply

Your server supports a maximum of two hot-swap power supplies.

Statement 8



CAUTION:

Never remove the cover on a power supply or any part that has the following label attached.



Hazardous voltage, current, and energy levels are present inside any component that has this label attached. There are no serviceable parts inside these components. If you suspect a problem with one of these parts, contact a service technician.

Complete the following steps to install a power supply:

1. Read the safety information beginning on page 121 and “System reliability considerations” on page 41.
2. (Some models) Remove the power-supply blank from the empty power-supply bay by pinching the side clip and pulling the power-supply blank from the bay. Save the power-supply blank in case you remove the power supply at a later time.

Attention: During normal operation, each power-supply bay must have either a power supply or power-supply blank installed for proper cooling.

3. Install the power supply in the bay:
 - a. Move the handle on the power supply into the open position, pinch the side clip, and slide the power supply into the chassis.
 - b. Gently close the handle to seat the power supply in the bay.

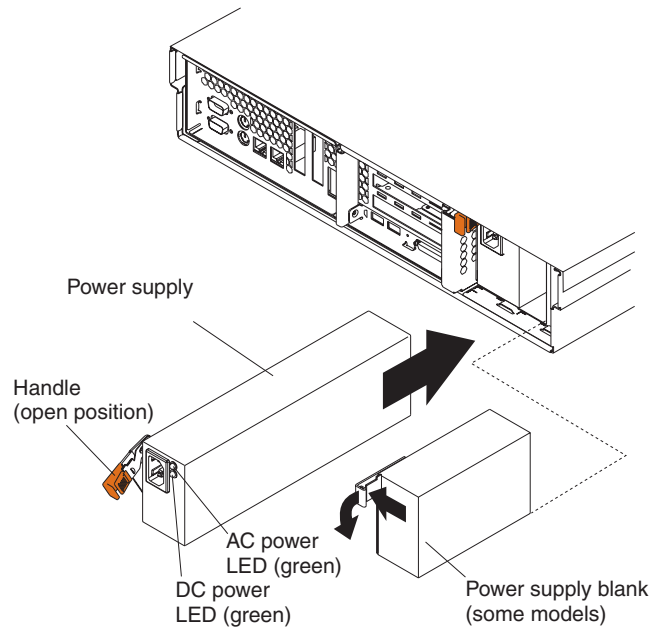

4. Plug the power cord for the new power supply into the power-cord connector on the power supply.

The following illustration shows the power-supply connectors on the back of the server.

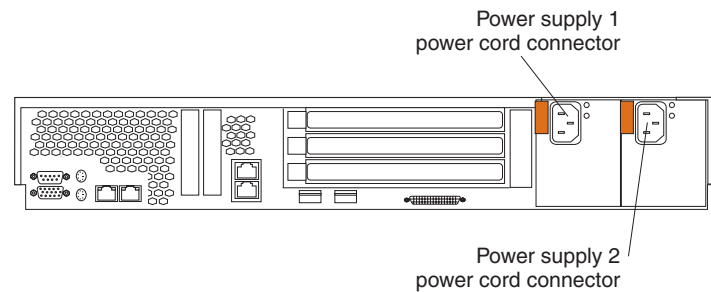

5. Route the power cord through the cable-management arm. (See “Installing the server in a rack” on page 70).
6. Plug the power cord into a properly grounded electrical outlet.
7. Verify that the dc power LED and ac power LED on the power supply are lit, indicating that the power supply is operating correctly.

Replacing a hot-swap fan

The following notes describe information that you must consider when installing a hot-swap fan.

Attention: To ensure proper server operation, if a fan fails, replace it as soon as possible.

- Your server supports a maximum of eight hot-swap fans.
- The following illustration shows the location of the hot-swap fans.

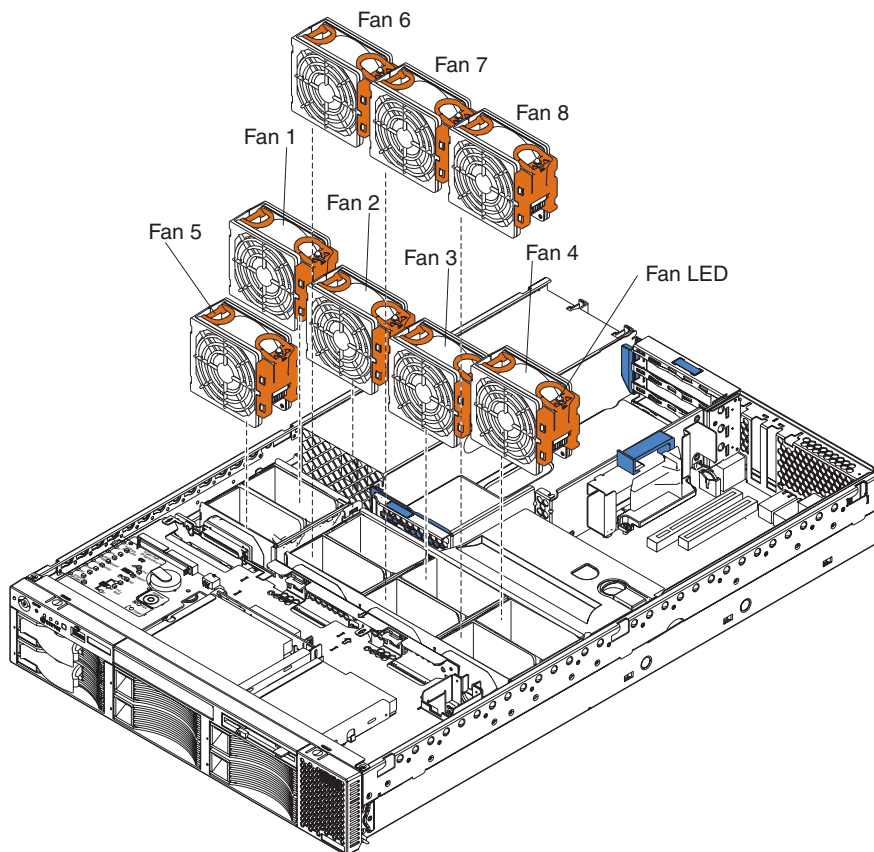

Complete the following steps to replace a hot-swap-fan:

1. Read the safety information beginning on page 121 and “System reliability considerations” on page 41.
2. Remove the cover. See “Removing the cover and bezel” on page 48. The LED on the failing fan assembly will be lit.

Attention: To ensure proper system cooling, do not remove the top cover for more than 30 minutes during this procedure.

3. Place your fingers into the two handles on the top of the failing fan.
4. Press the handles and lift the fan out of the server.
5. Orient the new fan so the LED on top of the fan is to the right of the server.
6. Push the replacement fan assembly into the server until it clicks into place.
7. Replace the cover. See “Installing the server cover and bezel” on page 70.

Replacing the battery

The following notes describe information that you must consider when replacing the battery:

- IBM has designed this product with your safety in mind. The lithium battery must be handled correctly to avoid possible danger. If you replace the battery, you must adhere to the following instructions.

Note: In the U. S., call 1-800-IBM-4333 for information about battery disposal.

- If you replace the original lithium battery with a heavy-metal battery or a battery with heavy-metal components, be aware of the following environmental consideration. Batteries and accumulators that contain heavy metals must not be disposed of with normal domestic waste. They will be taken back free of charge by the manufacturer, distributor, or representative, to be recycled or disposed of in a proper manner.
- To order replacement batteries, call 1-800-772-2227 within the United States, and 1-800-465-7999 or 1-800-465-6666 within Canada. Outside the U.S. and Canada, call your IBM reseller or IBM marketing representative.

Note: After you replace the battery, you must reconfigure your server and reset the system date and time.

Statement 2



CAUTION:

When replacing the lithium battery, use only IBM Part Number 33F8354 or an equivalent type battery recommended by the manufacturer. If your system has a module containing a lithium battery, replace it only with the same module type made by the same manufacturer. The battery contains lithium and can explode if not properly used, handled, or disposed of.

Do not:

- Throw or immerse into water.
- Heat to more than 100° C (212° F)
- Repair or disassemble

Dispose of the battery as required by local ordinances or regulations.

Complete the following steps to replace the battery:

1. Read the safety information beginning on page 121 and “System reliability considerations” on page 41.
2. Follow any special handling and installation instructions supplied with the battery.
3. Turn off the server and all attached devices, and disconnect all power cords and external cables (see “Turning off the server” on page 6).
4. Remove the server cover (see “Removing the cover and bezel” on page 48).
5. Remove the adapters from PCI slots 1 and 2 (see “Working with adapters” on page 48).
6. Disconnect any internal cables, as necessary.

7. Locate the battery (connector BH1) on the system board.

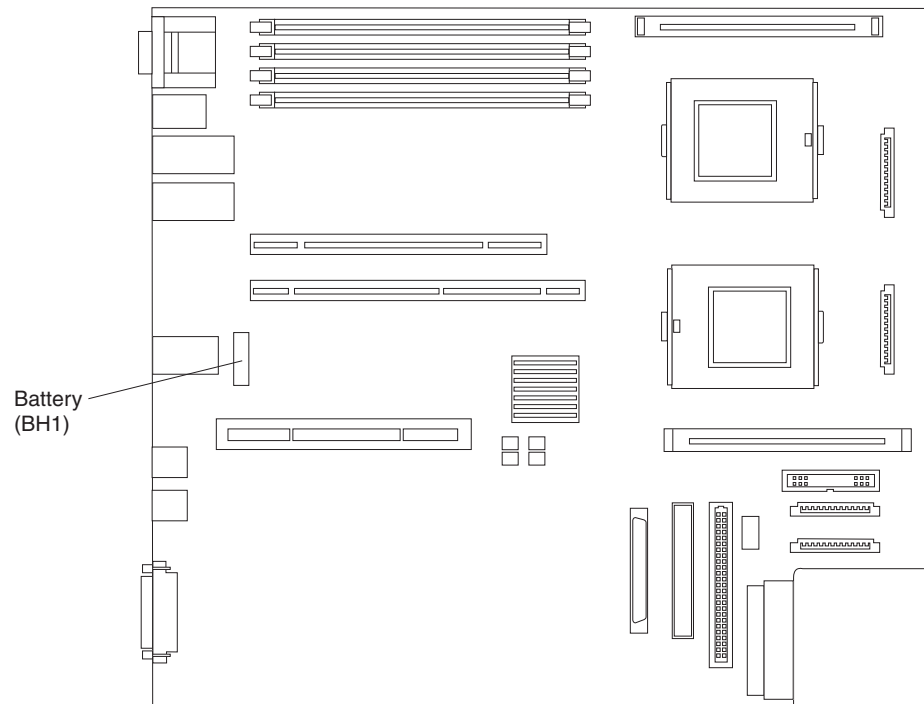

8. Remove the battery:
 - a. Use one finger to press the top of the battery clip away from the battery.
 - b. Lift and remove the battery from the socket.

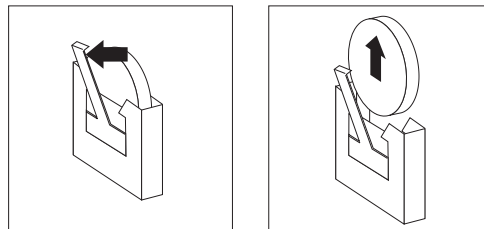

9. Insert the new battery:
 - a. Use one finger to press the top of the battery clip away from the battery.
 - b. Press the battery into the socket until it clicks into place. Make sure the battery clip holds the battery securely.

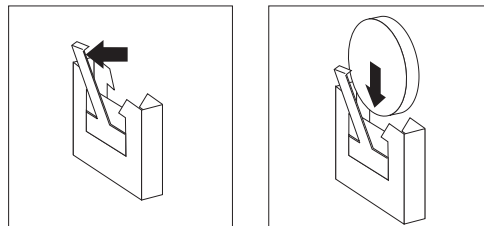

10. Reinstall the adapters that you removed, and reconnect the internal cables that you disconnected.
11. Connect all external cables and all power cords.
12. Reinstall the server cover (see "Installing the server cover and bezel" on page 70).

13. Start the Configuration/Setup Utility program, and set configuration parameters as needed. See “Using the Configuration/Setup Utility program” on page 11 for additional information about using the Configuration/Setup Utility program.

Completing the installation

To complete your installation, reinstall the bezel, reinstall the server cover, reconnect all cables that you disconnected earlier, and for certain options, run the Configuration/Setup Utility program. Follow the instructions in this section.

Attention:

- For proper cooling and airflow, replace the server cover before or shortly after turning on the server. Operating the server for extended periods of time (over 30 minutes) with the server cover removed might damage server components.
- To ensure proper server operation, do not remove the air-baffle assembly from the server except when installing or removing the components that are located under the air baffle.

Installing the server cover and bezel

Complete the following steps to install the server cover and bezel:

1. Place the cover-release latch in the open (up) position.
2. Insert the bottom tabs of the top cover into the matching slots in the server chassis.
3. Press down on the cover-release latch to lock the cover in place.
4. Align the hooks on the bottom of the bezel with the server.
5. Press the bezel toward the server until it clicks into place.

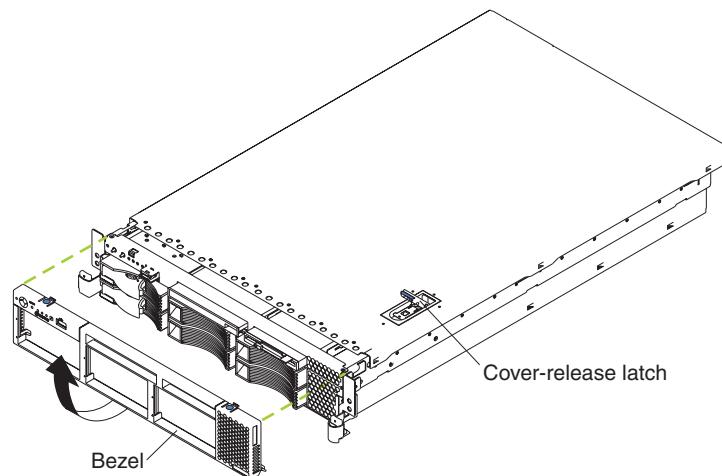

Installing the server in a rack

Detailed cabling instructions for a typical rack server configuration are in the *Rack Installation Instructions* that come with your server.

Updating your server configuration

When you start your server for the first time after you add or remove an internal option or an external SCSI device, you might see a message telling you that the configuration has changed. The Configuration/Setup Utility program automatically

starts so that you can save the new configuration information. See “Using the Configuration/Setup Utility program” on page 11 for more information about the Configuration/Setup Utility program.

If a ServeRAID 5i adapter is installed in PCI slot 2, POST disables the integrated SCSI controller. If you remove the ServeRAID 5i adapter from the server, the integrated SCSI controller must be enabled manually through the Configuration/Setup Utility program. Otherwise, the integrated SCSI controller will remain disabled.

Some options have device drivers that you need to install. See the documentation that comes with your option for information about installing any required device drivers.

Your server comes with one or two microprocessors installed on the system board. If your server comes with two microprocessors or if your server comes with one microprocessor and you have installed an additional microprocessor, your server can now operate as an SMP server. Therefore, you might need to upgrade your operating system to support SMP. See the *User's Guide* on the IBM *xSeries Documentation* CD and your operating-system documentation for additional information.

If you have a RAID configuration on your server using the integrated SCSI controller or if your server has a RAID controller installed and you have installed or removed a hard disk drive, you might need to reconfigure your disk arrays. See the RAID documentation on the IBM *xSeries Documentation* CD for information about reconfiguring your disk arrays.

Connecting external options

If you install a SCSI adapter or use the external SCSI connector, you can attach external SCSI devices, such as a SCSI storage expansion enclosure, to your server. You can attach additional external options to the other input/output (I/O) connectors on the front and rear of your server. (See “Input/output ports” on page 72 for more information.)

Complete the following steps to attach an external device:

1. Read the safety information beginning on page 121 and “System reliability considerations” on page 41. Also, read the documentation that comes with your options.
2. Turn off the server and all attached devices (see “Turning off the server” on page 6).
3. Follow the instructions that come with the option to prepare it for installation and to connect it to the server.

Note: If you are attaching an external SCSI device, see “Ultra320 SCSI controller system-board connectors” on page 74 for information about SCSI cabling and SCSI IDs.

Cabling the server

Notes:

1. You must turn off the server (see “Turning off the server” on page 6) before connecting any cables to or disconnecting any cables from the server.
2. See the documentation that comes with your options for additional cabling instructions. It might be easier for you to route cables before you install certain options.
3. Cable identifiers are printed on the cables that come with your server and options. Use these identifiers to connect the cables to the correct connectors.

The following illustrations show the locations of the input and output connectors on your server.

Rear view

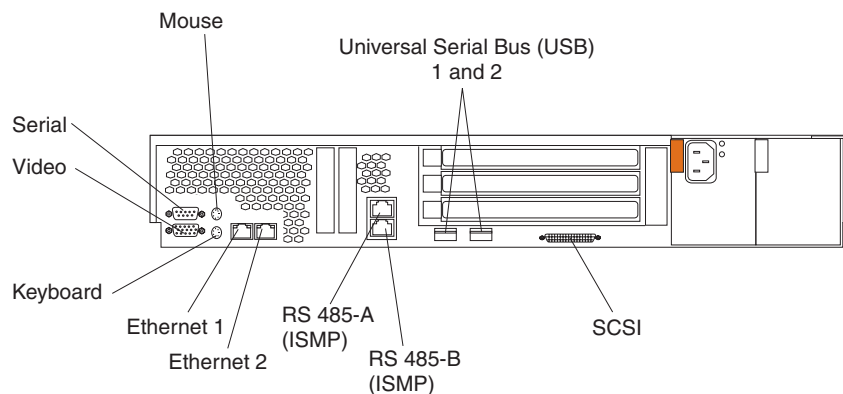

Front view

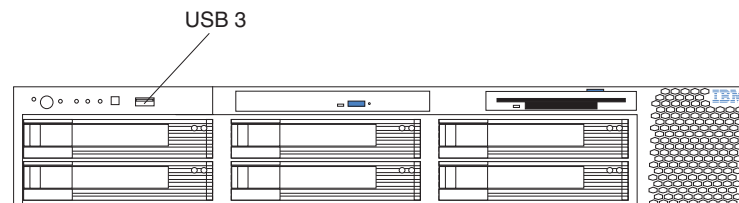

Input/output ports

This section provides information about the I/O ports on the rear of your server. These ports include the following:

- One video port
- One keyboard port
- One auxiliary-device port (pointing device) port
- One dual channel Ultra320 SCSI controller (LVD) SCSI port
- One serial port
- Three Universal Serial Bus (USB) version 1.1 ports (USB 1 and USB 2 on the rear, USB 3 on the front)
- Two Ethernet ports
- Two RS-485 communication ports dedicated to the integrated system-management processor (ISMP)

Video port

Your server comes with an integrated super video graphics array (SVGA) video controller. This controller is not removable, but you can disable it through the Configuration/Setup Utility program or by installing a PCI video adapter.

Note: If you install a PCI video adapter, the server BIOS will automatically disable the integrated video controller.

The following illustration shows the 15-pin analog video connector on the rear of your server. This connector conforms to the industry standard.

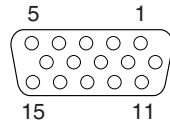

Keyboard port

There is one keyboard connector on the rear of your server.

Note: If you attach a standard (non-USB) keyboard to the keyboard connector, the USB ports and devices will be disabled during the power-on self-test (POST).

The following illustration shows the keyboard connector on the rear of your server. This connector conforms to the industry standard for a PS/2® keyboard.

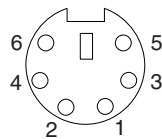

Auxiliary-device (pointing device) port

The system board has one auxiliary-device port that supports a mouse or other pointing device.

The following illustration shows the auxiliary-device connector on the rear of your server. This connector conforms to the industry standard for a PS/2 pointing device.

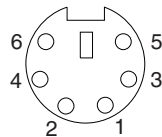

Ultra320 SCSI controller system-board connectors

Your server has an integrated dual channel small computer system interface (SCSI) controller with RAID capabilities. This controller supports two independent Ultra320 SCSI channels: one external and one internal. Each channel supports up to 15 SCSI devices. You can use the external LVD SCSI channel connector on the rear of your server to connect different types of SCSI devices, such as drives or printers. This controller uses:

- Double-transition clocking to achieve up to 320 MB-per-second data-transfer rates
- Domain name validation to negotiate compatible data-transfer speeds with each device
- Cyclic redundancy checking (CRC), instead of the usual parity checking, to improve data reliability
- An active terminator for SCSI bus termination

The server comes with one SCSI cable, which connects the internal connector on the system board to the standard hot-swap-drive backplane. If you plan to attach external SCSI devices, you must order additional cables. To select and order the correct cables for use with external devices, contact your IBM reseller or IBM marketing representative.

SCSI cabling requirements

For information about the maximum length of SCSI cable, go to the American National Standards Institute (ANSI) SCSI standards on the ANSI Web site at <http://www.ansi.org/> on the World Wide Web. Adhering to these standards will help to ensure that your server operates properly.

SCSI IDs

Each SCSI device that is connected to a SCSI controller must have a unique SCSI ID. This ID enables the SCSI controller to identify the device and ensure that different devices on the same SCSI channel do not attempt to transfer data simultaneously. SCSI devices that are connected to different SCSI channels can have duplicate SCSI IDs. Table 8 lists the SCSI IDs for the hard disk drives and backplanes that are connected to one channel.

Table 8. SCSI IDs for standard hot-swap hard disk drives, SCSI controller, and backplane

Device	SCSI ID
Drive bay 1	0
Drive bay 2	1
Drive bay 3	2
Drive bay 4	3
Drive bay 5	4
Drive bay 6	5
SCSI controller	7
Backplane	8

The hot-swap-drive backplane controls the SCSI IDs for the internal hot-swap drive bays. However, when you attach an external SCSI device to an optional SCSI adapter, you must set a unique ID for the device. See the information that comes with the device for instructions to set its SCSI ID.

SCSI connectors

The following illustration shows a 68-pin, female D-shell SCSI connectors. These connectors conform to the SCSI standard.



Serial port

Your server has one standard serial port. Some application programs require specific ports, and some modems function properly only at certain communication port addresses. You might need to use the Configuration/Setup Utility program to change communication port address assignments to prevent or resolve address conflicts.

Viewing or changing the serial-port assignments

Complete the following steps to view or change the serial-port assignments:

1. Restart the server, and watch the monitor screen.
2. When the message Press F1 for Configuration/Setup appears, press F1.
3. From the main menu, select **Devices and I/O Ports**; then, press Enter.

Note: The **Devices and I/O Ports** choice appears only on the full configuration menu. If you set two levels of passwords, you must type the administrator password to access the full configuration menu.

4. Select the serial port; then, use the arrow keys to advance through the available settings.
5. Select **Save Settings**; then, select **Exit Setup** to exit from the Configuration/Setup Utility main menu.

Serial-port connector

The following illustration shows the 9-pin, male D-shell serial-port connector on the rear of your server. This connector conforms to the industry standard.

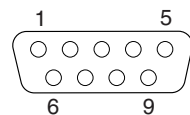

Universal Serial Bus version 1.1 ports

Your server has one Universal Serial Bus (USB) version 1.1 connector on the front of the server and two USB version 1.1 connectors on the rear of the server.

USB is a serial interface standard for telephony and multimedia devices. It uses Plug and Play technology to determine the type of device that is attached to the connector.

Notes:

1. If you attach a standard (non-USB) keyboard to the keyboard connector, the USB ports and devices will be disabled during the power-on self-test (POST).
2. If you install a USB keyboard that has a mouse port, the USB keyboard emulates a mouse, and you will not be able to disable the mouse settings in the Configuration/Setup Utility program.

3. Check to make sure that your network operating system (NOS) supports USB devices.
4. For additional information about USB version 1.1 devices, go to <http://www.usb.org/>.

USB cables and hubs

You need a 4-pin cable to connect USB devices. If you plan to attach more than three USB devices, you must use a hub to connect the devices. The hub provides multiple connectors for attaching additional external USB devices.

USB technology provides up to 12 Mb-per-second (Mbps) speed with a maximum of 127 devices and a maximum cable length of five meters (16 ft).

USB-port connectors

Each USB port has an external connector on the front or rear of the server for attaching USB-compatible devices.

The following illustration shows a USB-port connector. These connectors conform to the USB version 1.1 standard.

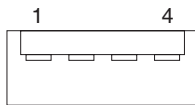

Ethernet ports

Your server comes with an integrated dual-port Ethernet controller. This controller provides an interface for connecting to 10-Mbps, 100-Mbps, or 1000-Mbps networks and provides full-duplex capability, which enables simultaneous transmission and reception of data on the Ethernet LAN.

To access the Ethernet controller, connect a Category 5, or higher, unshielded twisted-pair (UTP) cable to either of the Ethernet (RS-45) connectors on the rear of your server. See “System-board external port connectors” on page 45.

There are two RS-45 Ethernet connectors on the back of the server. See “System-board external port connectors” on page 45 for the location of these connectors.

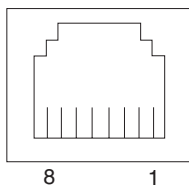

Integrated system-management ports

The RS-485 connectors are used for the ISMP interconnect function. The ISMP interconnect function uses these connectors to daisy-chain several system service processors together. This function enables the service processors to communicate with each other in half-duplex mode.

Chapter 5. Field replaceable units

The following information describes procedures for removing and installing certain components inside the server. Only a qualified service technician is authorized to access the components described in this section.

Important: The field-replaceable unit (FRU) procedures are intended for trained servicers who are familiar with IBM xSeries products. See the parts listing in “System” on page 114 to determine if the component being replaced is a customer-replaceable unit (CRU) or a FRU.

Hard disk drive backplane

This section contains instructions for removing and replacing the hard disk drive backplane.

Before you begin:

- Read “Before you begin” on page 41.
- Read the safety notices in “Safety notices (multilingual translations)” on page 124.
- Read “Handling static-sensitive devices” on page 42.

Complete the following steps to remove the hard disk drive backplane:

1. Turn off the server and any attached devices.
2. Disconnect external cables and option cables from the back of the server.
3. Remove the hard disk drives.
4. Remove the server cover (see “Removing the cover and bezel” on page 48).
5. Disconnect the two cables from the diagnostics/operator panel card.
6. Disconnect the hard disk drive cable from the backplane.
7. Disconnect the two cables from the back of the CD-ROM drive.
8. Press on the two backplane release tabs, and remove the backplane from the server.

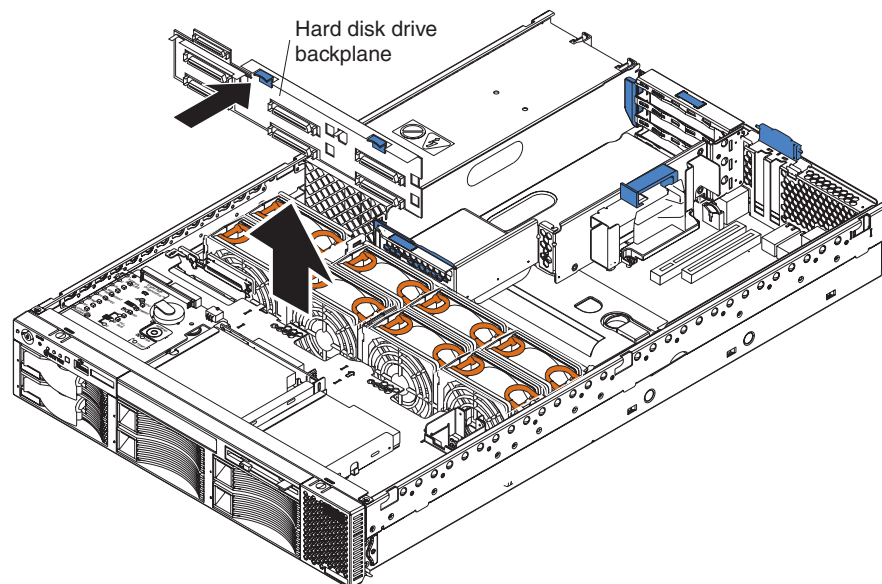

9. Disconnect the power cable from the backplane.

To replace the hard disk drive backplane, reverse the previous steps.

Note: When reinstalling the hard disk drive backplane, engage the left-most tab first.

Diagnostics/operator panel card

This section contains instructions for removing and replacing the diagnostics/operator panel card.

Before you begin:

- Read “Before you begin” on page 41.
- Read the safety notices in “Safety notices (multilingual translations)” on page 124.
- Read “Handling static-sensitive devices” on page 42.

Complete the following steps to remove the diagnostics/operator panel card:

1. Turn off the server and any attached devices.
2. Disconnect external cables and option cables from the back of the server.
3. Remove the server cover (see “Removing the cover and bezel” on page 48).
4. Disconnect the three cables from the card.
5. Remove the two screws from the card.
6. Remove the diagnostics/operator panel card from the server.

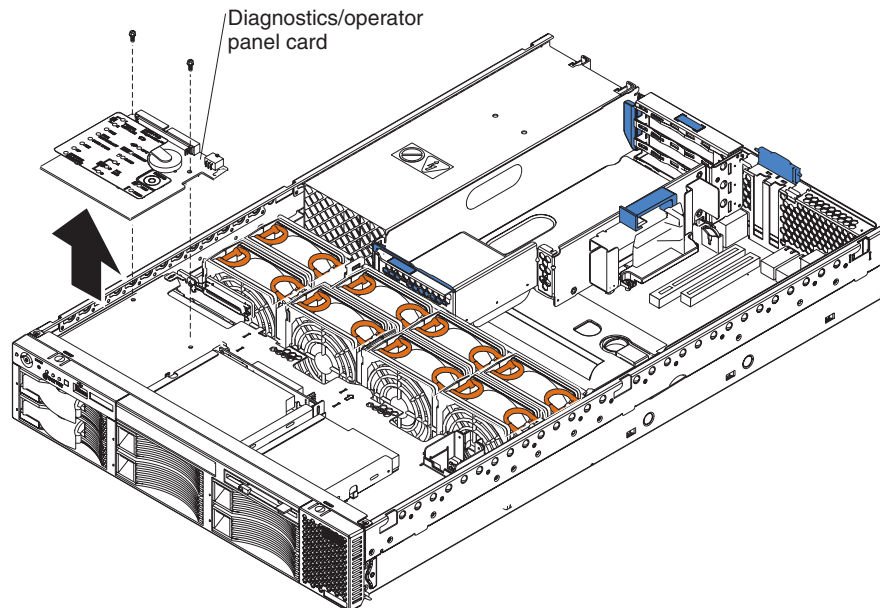

To replace the diagnostics/operator panel card, reverse the previous steps.

Power-supply cage

This section contains instructions for removing and replacing the power-supply cage.

Before you begin:

- Read “Before you begin” on page 41.
- Read the safety notices in “Safety notices (multilingual translations)” on page 124.
- Read “Handling static-sensitive devices” on page 42.

Complete the following steps to remove the power-supply cage:

1. Turn off the server and any attached devices.
2. Disconnect external cables and option cables from the back of the server.
3. Remove the server cover (see “Removing the cover and bezel” on page 48).
4. Remove the air baffle.
5. Disconnect the four power-supply cage cables.

Note: To disconnect the power cable to the hard disk drive backplane, partially remove the hard disk drive backplane. (See “Hard disk drive backplane” on page 77..)

6. Remove the three screws from the power-supply cage.

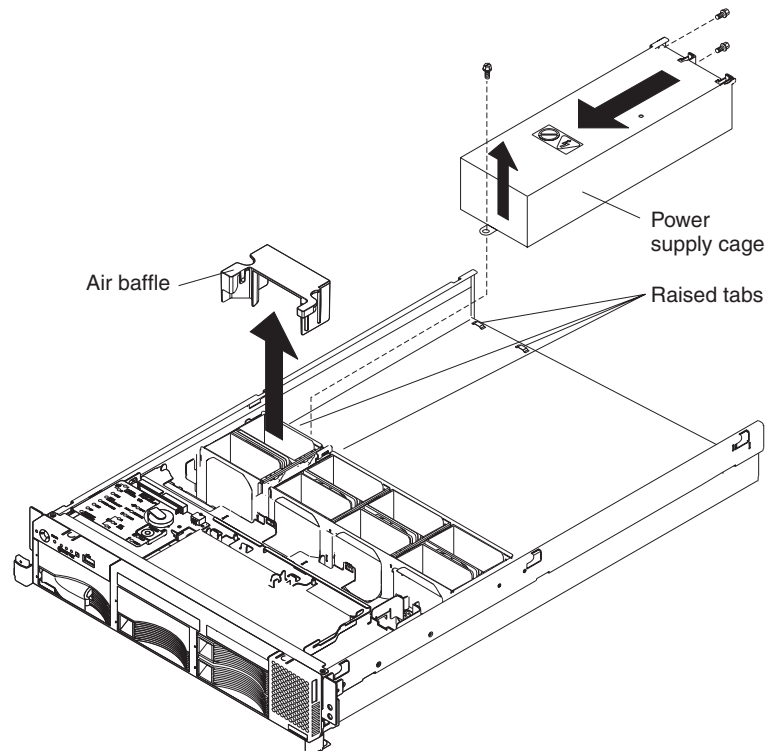

7. Remove the power-supply cage from the server.

To replace the power-supply cage, reverse the previous steps.

Note: Tilt the power-supply cage during installation so that you insert the rear of the cage first.

System-board shuttle

This section contains instructions for removing and replacing the system-board shuttle.

Before you begin:

- Read “Before you begin” on page 41.
- Read the safety notices in “Safety notices (multilingual translations)” on page 124.
- Read “Handling static-sensitive devices” on page 42.

Complete the following steps to remove the system-board shuttle:

1. Turn off the server and any attached devices.

Note: When replacing the system board, you must either update the server with the latest firmware or restore the pre-existing firmware that the customer provides on a diskette or CD image.

2. Disconnect external cables and option cables from the back of the server.
3. Remove the cover (see “Removing the cover and bezel” on page 48).
4. Disconnect and remove adapters (see “Working with adapters” on page 48).
5. Disconnect all cables from the system board.
6. Remove all microprocessors and VRMs, and set them aside on a static-protected surface for reinstallation (see “Installing a microprocessor” on page 58).
7. Remove the memory modules, and set them aside on a static-protected surface for reinstallation (see “Installing memory modules” on page 56).
8. Release the shuttle locking latch, and remove the shuttle from the server.

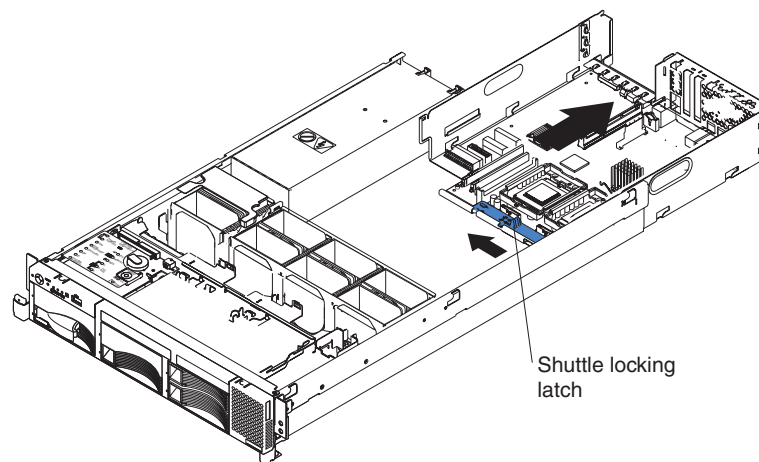

To replace the system board shuttle, slide the shuttle into the server and close the shuttle locking latch. Reverse steps 4 through 7 to replace the components that were removed.

Chapter 6. Symptom-to-FRU index

This index supports xSeries 345 servers.

Notes:

1. Check the configuration before you replace a FRU. Configuration problems can cause false errors and symptoms.
2. For IBM devices not supported by this index, refer to the manual for that device.
3. Always start with “General checkout” on page 25.

The symptom-to-FRU index lists symptoms, errors, and the possible causes. The most likely cause is listed first. Use this symptom-to-FRU index to help you decide which FRUs to have available when servicing the system.

The first column of the two-column tables in this index lists error codes or messages, and the second column lists one or more suggested actions or FRUs to replace. Take the action (or replace the FRU) suggested first in the list of the second column, then try the server again to see if the problem has been corrected.

Note: Try reseating a suspected component or reconnecting a cable before replacing the component.

The POST BIOS code displays POST error codes and messages on the screen.

Beep symptoms

Beep symptoms are short tones or a series of short tones separated by pauses (intervals without sound). See the examples in the following table.

Beeps	Description
1-2-3	<ul style="list-style-type: none">• One beep• A pause (or break)• Two beeps• A pause (or break)• Three beeps
4	Four continuous beeps

One beep after successfully completing POST indicates the system is functioning properly.

Note: See “System” on page 114 to determine which components a field service technician should replace.

Beep/symptom	FRU/action
1-1-2 (Microprocessor register test failed)	<ol style="list-style-type: none">1. Optional microprocessor (if installed)2. Microprocessor3. System board
1-1-3 (CMOS write/read test failed)	<ol style="list-style-type: none">1. Battery2. System board
1-1-4 (BIOS EEPROM checksum failed)	<ol style="list-style-type: none">1. Recover BIOS2. System board

Note: See “System” on page 114 to determine which components a field service technician should replace.

Beep/symptom	FRU/action
1-2-1 (Programmable Interval Timer failed)	System board
1-2-2 (DMA initialization failed)	System board
1-2-3 (DMA page register write/read failed)	System board
1-2-4 (RAM refresh verification failed)	1. DIMM 2. System board
1-3-1 (first 64K RAM test failed)	DIMM
2-1-1 (Secondary DMA register failed)	System board
2-1-2 (Primary DMA register failed)	System board
2-1-3 (Primary interrupt mask register failed)	System board
2-1-4 (Secondary interrupt mask register failed)	System board
2-2-1 (Interrupt vector loading failed)	System board
2-2-2 (Keyboard controller failed)	1. System board 2. Keyboard
2-2-3 (CMOS power failure and checksum checks failed)	1. Battery 2. System board
2-2-4 (CMOS configuration information validation failed)	1. Battery 2. System board
2-3-1 (Screen initialization failed)	System board
2-3-2 (Screen memory failed)	System board
2-3-3 (Screen retrace failed)	System board
2-3-4 (Search for video ROM failed)	System board
2-4-1 (Video failed; screen believed operable)	System board
3-1-1 (Timer tick interrupt failed)	System board
3-1-2 (Interval timer channel 2 failed)	System board

Note: See “System” on page 114 to determine which components a field service technician should replace.

Beep/symptom	FRU/action
3-1-3 (RAM test failed above address OFFFFH))	<ol style="list-style-type: none"> 1. DIMM 2. System board
3-1-4 (Time-Of-Day clock failed)	<ol style="list-style-type: none"> 1. Battery 2. System board
3-2-1 (Serial port failed)	System board
3-2-2 (Parallel port failed)	System board
3-2-3 (Math coprocessor test failed)	<ol style="list-style-type: none"> 1. Microprocessor 2. System board
3-2-3 (Failure comparing CMOS memory size against actual)	<ol style="list-style-type: none"> 1. DIMM 2. Battery
3-3-1 (Memory size mismatch occurred.)	<ol style="list-style-type: none"> 1. DIMM 2. Battery
3-3-2 (Critical SMBUS error occurred)	<ol style="list-style-type: none"> 1. Disconnect the server power cord from outlet, wait 30 seconds, and retry. 2. System board. 3. DIMMs. 4. Hard disk drive backplane. 5. Power supply. 6. Power cage assembly. 7. 12C Cable.
3-3-3 (No operational memory in system)	<ol style="list-style-type: none"> 1. Install or reseat the memory modules, and then do a 3 boot reset. (For more information on a 3 boot reset, see “Using the Configuration/Setup Utility program” on page 11). 2. DIMMs. 3. Memory board. 4. System board.
4-4-4 (Optional system management adapter not installed in slot 1 or not functioning correctly)	<ol style="list-style-type: none"> 1. Verify that the adapter is installed in slot 1. 2. Adapter. 3. System board.
Two short beeps (Information only, the configuration has changed)	<ol style="list-style-type: none"> 1. Run Diagnostics. 2. Run the Configuration/Setup Utility program.
Three short beeps	<ol style="list-style-type: none"> 1. DIMM 2. System board
One continuous beep	<ol style="list-style-type: none"> 1. Microprocessor 2. Optional microprocessor (if installed) 3. System board
Repeating short beeps	<ol style="list-style-type: none"> 1. Keyboard 2. System board

Note: See “System” on page 114 to determine which components a field service technician should replace.	
Beep/symptom	FRU/action
One long and one short beep	<ol style="list-style-type: none"> 1. Video adapter (if installed) 2. System board
One long and two short beeps	<ol style="list-style-type: none"> 1. Video adapter (if installed) 2. System board
One long and three short beeps	<ol style="list-style-type: none"> 1. Monitor 2. Video adapter, if installed 3. System board
Two long and two short beeps	Video adapter

No-beep symptoms

Note: See “System” on page 114 to determine which components a field service technician should replace.	
No-beep symptom	FRU/action
No beep and the system operates correctly.	<ol style="list-style-type: none"> 1. Check speaker cables. 2. Speaker. 3. System board.
No beeps occur after successfully completing POST (the power-on status is disabled)	<ol style="list-style-type: none"> 1. Run the Configuration/Setup Utility program, and set the Start Options Power-On Status to enable. 2. Check the speaker connection. 3. System board.
No ac power (power supply ac LED is off)	<ol style="list-style-type: none"> 1. Check the power cord. 2. Power supply. (If two are installed, swap them to determine if one is defective.) 3. Disconnect the ribbon cable from connector J25 on the system board. If the ac power LED comes on, see “Undetermined problems” on page 110. 4. Power cage assembly.
No beep and no video	See “Undetermined problems” on page 110.
System will not start (power supply ac LED is on)	See “Power-supply LED errors” on page 99.

Diagnostic panel system-error LED

The system-error LED is lit when an error is detected. If the system-error LED is lit, remove the cover, and check the diagnostic panel LEDs. The following table is a complete list of diagnostics panel LEDs followed by the FRU or action for correcting the problem. The information in the table is valid only when the system-error LED is lit.

Notes:

1. If a diagnostics panel LED is lit and the information LED panel system-error LED is off, there is probably an LED problem. Run LED diagnostics.
2. To locate the LEDs on the system board, see “System-board LED locations” on page 47.
3. Check the system-error log for additional information before replacing a FRU.

4. The DIMM error LEDs, microprocessor error LEDs, and VRM error LEDs turn off when the system is turned off.

Note: See “System” on page 114 to determine which components a field service technician should replace.	
Diagnostics panel LED	FRU/action
All LEDs off (System-error log is 75% full; clear the log.)	<ol style="list-style-type: none"> 1. Check the system-error log for the error condition; then, clear the system-error log when the problem is found. 2. PFA alert; check log for failure; clear PFA alert; remove ac power for at least 20 seconds, reconnect, then turn on the system. 3. Run Light Path Diagnostics.
FAN LED on (The LED next to the failing fan is on.)	<ol style="list-style-type: none"> 1. Failing fan. 2. System board
MEMORY LED on (The LED next to the failing DIMM is on.)	<ol style="list-style-type: none"> 1. Failing DIMM. 2. System board
CPU LED on (The LED next to the failing CPU is on.)	<ol style="list-style-type: none"> 1. Run the Configuration/Setup Utility program to verify that all microprocessors have identical cache sizes, clock speeds and clock frequencies. 2. Microprocessor 1 or 2. 3. System board.
PCI BUS LED on	<ol style="list-style-type: none"> 1. Remove all PCI adapters from slots on affected bus (see “System-board LED locations” on page 47 for bus information, see “Working with adapters” on page 48). 2. System board.
VRM LED on (The LED next to the failing VRM is on.)	<ol style="list-style-type: none"> 1. Voltage regulator module indicated by the lit VRM LED 2. Microprocessor indicated by the microprocessor LED
DASD LED on (The LED located next to the drive bay that the failing drive is installed in is lit. Check the amber drive LED for the failing hard drive.)	<ol style="list-style-type: none"> 1. Be sure the fans are operating correctly and the airflow is good. 2. If installed, reseal I2C cable between hard disk drive backplane and hard disk drive I2C on the system board (J10). 3. Failing drive. SCSI channel A has failed. (This is the SCSI channel for the hot-swap hard disk drives). 4. Hard disk drive backplane.
ISMP LED (Integrated System Management detects an internal error.)	<ol style="list-style-type: none"> 1. Update ISMP firmware with latest level code. Unplug ac power from the server for at least 30 seconds, and then retry. 2. System board.
POWER SUPPLY 1 LED on	<ol style="list-style-type: none"> 1. Check the dc good LED on power supply 1. If it is off, replace power supply 1. 2. Power cage assembly.
POWER SUPPLY 2 LED on	<ol style="list-style-type: none"> 1. Check the dc good LED on power supply 2. If it is off, replace power supply 2. 2. Power cage assembly.
NONREDUNDANT LED on	<ol style="list-style-type: none"> 1. Check the PS1 and PS2 LEDs and replace any indicated power supply. 2. Install an additional power supply or remove optional devices from the server.
NMI LED on	<ol style="list-style-type: none"> 1. Restart the server. 2. Check the system-error log.

Note: See “System” on page 114 to determine which components a field service technician should replace.	
Diagnostics panel LED	FRU/action
TEMPERATURE LED on	<ol style="list-style-type: none"> 1. Ambient temperature must be within normal operating specifications. See “Features and specifications” on page 3. 2. Ensure fans are operating correctly. 3. Ensure that both air baffles are installed. 4. Examine system-error log. <ol style="list-style-type: none"> a. System over recommended temperature - Information LED panel b. Hard disk drive over recommended temperature (DASD LED also on) <ol style="list-style-type: none"> 1) Overheating hard drive 2) Hard disk drive backplane c. System over recommended temperature for CPU x (where x is 1 or 2) (CPU LED is also on) <ol style="list-style-type: none"> 1) Microprocessor x 2) System board 5. If the CPU LED on the diagnostics panel is also lit, one of the microprocessors has caused the error.
CPU/VRM MISMATCH LED on	<ol style="list-style-type: none"> 1. Move the microprocessor in socket 1 to socket 2, and move the microprocessor in socket 2 to socket 1. 2. Ensure that both microprocessors are of the same type, with the same core frequency and the same L2 size. 3. Ensure that both VRMs are of the same type. 4. Ensure that both VRMs are supported in your server model. 5. If a microprocessor is missing from socket 1, install a microprocessor in socket 1.
FAN LED on	<ol style="list-style-type: none"> 1. Check individual fan LEDs. 2. Replace respective fan. 3. Fan cable. 4. System board. 5. Power cage assembly.

Diagnostic error codes

Note: In the following error codes, if *XXX* is *000*, *195*, or *197*, do not replace a FRU. The description for these error codes are:

- 000** The test passed.
- 195** The Esc key was pressed to stop the test.
- 197** Warning; a hardware failure might not have occurred.

For all error codes, replace the FRU or take the action indicated.

Note: See “System” on page 114 to determine which components a field service technician should replace.	
Error code/symptom	FRU/action
001-XXX-000 (Failed core tests)	System board
001-XXX-001 (Failed core tests)	System board
001-250-000 (Failed system board ECC)	System board
001-250-001 (Failed system board ECC)	System board
005-XXX-000 (Failed video test)	System board
011-XXX-000 (Failed COM1 serial port test)	System board
011-XXX-001 (Failed COM2 serial port test)	System board
014-XXX-000 (Failed parallel port test)	System board
015-XXX-001 (USB interface not found, board damaged)	System board
015-XXX-015 (Failed USB external loopback test)	<ol style="list-style-type: none"> 1. Make sure the parallel port is not disabled. 2. Run the USB external loopback test again. 3. System board.
015-XXX-198 (USB device connected during USB test)	<ol style="list-style-type: none"> 1. Remove USB devices from USB1 and USB2. 2. Run the USB external loopback test again. 3. System board.
020-XXX-000 (Failed PCI interface test)	System board
020-XXX-001 (Failed hot-swap slot 1 PCI latch test)	<ol style="list-style-type: none"> 1. PCI hot-swap latch assembly 2. System board
020-XXX-002 (Failed Hot-swap slot 2 PCI latch test)	<ol style="list-style-type: none"> 1. PCI hot-swap latch assembly 2. System board
020-XXX-003 (Failed hot-swap slot 3 PCI latch test)	<ol style="list-style-type: none"> 1. PCI hot-swap latch assembly 2. System board
020-XXX-004 (Failed hot-swap slot 4 PCI latch test)	<ol style="list-style-type: none"> 1. PCI hot-swap latch assembly 2. System board
030-XXX-000 (Failed internal SCSI interface test)	System board
035-XXX-099 (No adapters were found.)	If adapter is installed re-check connection.
035-XXX-S99 (Failed RAID test on PCI slot S. S = number of failing PCI slot. Check System Error Log before replacing a FRU.)	<ol style="list-style-type: none"> 1. Adapter 2. SCSI backplane 3. Cable
035-XXX-SNN (Check System Error Log before replacing a FRU. s = number of failing PCI slot, nn = SCSI ID of failing fixed disk.)	Hard disk drive with SCSI ID nn on RAID adapter in PCI slot s.

Note: See “System” on page 114 to determine which components a field service technician should replace.

Error code/symptom	FRU/action
035-253-S99 (RAID adapter initialization failure)	<ol style="list-style-type: none"> 1. ServeRAID adapter in slot s is not configured properly. Obtain the basic and extended configuration status, and see the <i>ServeRAID Hardware Maintenance Manual</i> for more information. 2. Cable. 3. SCSI backplane. 4. Adapter.
075-XXX-000 (Failed power supply test)	Power supply
089-XXX-001 (Failed microprocessor test)	<ol style="list-style-type: none"> 1. VRM 1 for microprocessor 1 2. Microprocessor 1
089-XXX-002 (Failed optional microprocessor test)	<ol style="list-style-type: none"> 1. VRM 2 for optional microprocessor 2 2. Optional microprocessor 2
166-198-000 System Management: Aborted (Unable to communicate with ASM. It may be busy. Run the test again.)	<ol style="list-style-type: none"> 1. Run the diagnostic test again. 2. Correct other error conditions and retry. These include other failed system-management tests and items logged in the system-error log of the optional Remote Supervisor Adapter. 3. Disconnect all server and option power cords from the server, wait 30 seconds, reconnect, and retry. 4. Remote Supervisor Adapter, if installed. 5. System board.
166-201-001 System Management: Failed (I2C bus error(s) See SERVPROC and DIAGS entries in event log.)	<ol style="list-style-type: none"> 1. If installed, reseat the I2C cable between the Remote Supervisor Adapter (in PCI slot 5/J5 on the PCI riser card) and system management connector on the PCI riser card. 2. Reseat memory DIMMs. 3. Memory DIMMs. 4. System board.
166-201-002 System Management: Failed (I2C bus error(s) See SERVPROC and DIAGS entries in event log.)	<ol style="list-style-type: none"> 1. Reseat I2C cable between the operator information panel and the system board (J22). 2. Diagnostics panel. 3. System board.
166-201-003 System Management: Failed (I2C bus error(s) See SERVPROC and DIAGS entries in event log.)	<ol style="list-style-type: none"> 1. Reseat cables between the system board and the power supply or power cage assembly. 2. Power cage assembly. 3. System board.
166-201-004 System Management: Failed (I2C bus error(s) See SERVPROC and DIAGS entries in event log.)	<ol style="list-style-type: none"> 1. Hard disk drive backplane 2. System board
166-201-005 System Management: Failed (I2C bus error(s) See SERVPROC and DIAGS entries in event log.)	<ol style="list-style-type: none"> 1. Reseat Memory DIMMs. 2. Reseat microprocessors. 3. Memory DIMMs. 4. Microprocessors. 5. System board.

Note: See “System” on page 114 to determine which components a field service technician should replace.

Error code/symptom	FRU/action
166-250-000 System Management: Failed (I2C cable is disconnected. Reconnect I2C cable between Remote Supervisor Adapter and system board.)	<ol style="list-style-type: none"> 1. If installed, reseal the I2C cable between the Remote Supervisor Adapter (in PCI slot 5/J5 on the PCI riser card) and system-management connector on the PCI riser card. 2. I2C cables. 3. Advanced System Management adapter. 4. System board.
166-260-000 System Management: Failed (Restart ASM Error. After restarting, ASM communication was lost. Unplug and cold boot to reset ASM.)	<ol style="list-style-type: none"> 1. Disconnect all server and option power cords from the server, wait 30 seconds, reconnect, and retry. 2. Reseat the Remote Supervisor Adapter in PCI slot 5/J5 on the PCI riser card. 3. Remote Supervisor Adapter.
166-342-000 System Management: Failed (ASM adapter BIST indicate failed tests.)	<ol style="list-style-type: none"> 1. Ensure the latest firmware levels for Remote Supervisor Adapter and BIOS. 2. Disconnect all server and option power cords from server, wait 30 seconds, reconnect, and retry. 3. Remote Supervisor Adapter.
166-400-000 System Management: Failed (ISMP self test result failed tests: x where x = Flash, RAM, or ROM.)	<ol style="list-style-type: none"> 1. Reflash or update firmware for ISMP. 2. System board.
180-XXX-000 (Diagnostics LED failure)	Run diagnostics panel LED test for the failing LED.
180-XXX-001 (Failed front LED panel test)	<ol style="list-style-type: none"> 1. Operator information panel 2. System board
180-XXX-002 (Failed diagnostics LED panel test)	<ol style="list-style-type: none"> 1. Diagnostics panel 2. System board
180-361-003 (Failed fan LED test)	<ol style="list-style-type: none"> 1. Fan(s) 2. System board
180-XXX-003 (Failed system board LED test)	System board
180-XXX-005 (Failed SCSI backplane LED test)	<ol style="list-style-type: none"> 1. SCSI backplane 2. SCSI backplane cable 3. System board
201-XXX-0NN (Failed memory test.)	<ol style="list-style-type: none"> 1. DIMM Location slots 1-6 where nn = DIMM location. Note: nn 1=DIMM 1; 2=DIMM 2; 3=DIMM 3; 4=DIMM 4. 2. System board
201-XXX-999 (Multiple DIMM failure, see error text)	<ol style="list-style-type: none"> 1. See error text for failing DIMMs. 2. System board.
202-XXX-001 (Failed system cache test)	<ol style="list-style-type: none"> 1. VRM 1 2. Microprocessor 1
202-XXX-002 (Failed system cache test)	<ol style="list-style-type: none"> 1. VRM 2 2. Microprocessor 2

Note: See “System” on page 114 to determine which components a field service technician should replace.

Error code/symptom	FRU/action
206-XXX-000 (Failed diskette drive test)	<ol style="list-style-type: none"> 1. Rerun the test with a different diskette. 2. Cable. 3. Diskette drive. 4. System board.
215-XXX-000 (Failed IDE CD-ROM drive test)	<ol style="list-style-type: none"> 1. Rerun the test with a different CD-ROM. 2. CD-ROM drive cables. 3. CD-ROM drive. 4. System board.
217-198-XXX (Could not establish drive parameters)	<ol style="list-style-type: none"> 1. Check cable and termination. 2. SCSI backplane. 3. Hard disk.
217-XXX-000 (Failed BIOS hard disk test) Note: If RAID is configured, the hard disk number refers to the RAID logical array.	Hard disk 1
217-XXX-001 (Failed BIOS hard disk test) Note: If RAID is configured, the hard disk number refers to the RAID logical array.	Hard disk 2
217-XXX-002 (Failed BIOS hard disk test) Note: If RAID is configured, the hard disk number refers to the RAID logical array.	Hard disk 3
217-XXX-003 (Failed BIOS hard disk test) Note: If RAID is configured, the hard disk number refers to the RAID logical array.	Hard disk 4
217-XXX-004 (Failed BIOS hard disk test) Note: If RAID is configured, the hard disk number refers to the RAID logical array.	Hard disk 5
217-XXX-005 (Failed BIOS hard disk test) Note: If RAID is configured, the hard disk number refers to the RAID logical array	Hard disk 6
264-XXX-0NN (Failed tape drive test)	<ol style="list-style-type: none"> 1. Tape cartridge, if user executed the Read/Write Tape Drive test (failure code of XXX = 256) 2. SCSI or power cable connected to tape drive with SCSI ID <i>nn</i> 3. Tape drive with SCSI ID <i>nn</i> (refer to the Help and Service Information appendix of the tape drive <i>User Guide</i>) 4. System board or SCSI controller (run SCSI controller diagnostic to determine if the SCSI bus is functioning properly.)
264-XXX-999 (Errors on multiple tape drives, see error text for more info)	See error messages/text in the PC Doctor error log for detailed information on each individual tape drive error.
301-XXX-000 (Failed keyboard test)	Keyboard

Note: See “System” on page 114 to determine which components a field service technician should replace.	
Error code/symptom	FRU/action
405-XXX-000 (Failed Ethernet test on controller on the system board)	<ol style="list-style-type: none"> 1. Verify that Ethernet is not disabled in BIOS. 2. System board.
405-XXX-00N (Failed Ethernet test on adapter in PCI slot <i>n</i>)	<ol style="list-style-type: none"> 1. Adapter in PCI slot <i>n</i> 2. System board
415-XXX-000 (Failed Modem test)	<ol style="list-style-type: none"> 1. Cable. Note: Ensure modem is present and attached to server. 2. Modem. 3. System board.

Error symptoms

You can use the error symptom table to find solutions to problems that have definite symptoms.

If you cannot find the problem in the error symptom charts, go to “Starting the diagnostic programs” on page 30 to test the server.

If you have just added new software or a new option and the server is not working, complete the following steps before using the error symptom charts:

1. Remove the software or device that you just added.
2. Run the diagnostic tests to determine if the server is running correctly.
3. Reinstall the new software or new device.

In the following table, if the entry in the FRU/action column is a suggested action, perform that action; if it is the name of a component, reseal the component, and replace it if necessary. The most likely cause of the symptom is listed first.

Note: See “System” on page 114 to determine which components should be replaced by a field service technician.	
CD-ROM drive problems	
Symptom	FRU/action
CD-ROM drive is not recognized.	<ol style="list-style-type: none"> 1. Verify that: <ul style="list-style-type: none"> • The IDE channel to which the CD-ROM drive is attached (primary or secondary) is enabled in the Configuration/Setup Utility program. • All cables and jumpers are installed correctly. • The correct device driver is installed for the CD-ROM drive. 2. Run CD-ROM drive diagnostics. 3. CD-ROM drive.
CD is not working properly.	<ol style="list-style-type: none"> 1. Clean the CD. 2. Run CD-ROM drive diagnostics. 3. CD-ROM drive.
CD-ROM drive tray is not working. (The server must be turned on.)	<ol style="list-style-type: none"> 1. Insert the end of a straightened paper clip into the manual tray-release opening. 2. Run CD-ROM drive diagnostics. 3. CD-ROM drive.

Note: See “System” on page 114 to determine which components a field service technician should replace.	
Diskette drive problems	
Symptom	FRU/action
Diskette drive activity LED stays on, or the system bypasses the diskette drive.	<ol style="list-style-type: none"> 1. If there is a diskette in the drive, verify that: <ul style="list-style-type: none"> • The diskette drive is enabled in the Configuration/Setup utility program. • The diskette is not damaged. (Try another diskette if you have one.) • The diskette is inserted correctly in the drive. • The diskette contains the necessary files to start the server. • The software program is working properly. • The cable is installed correctly (in the proper orientation). 2. To prevent diskette drive read/write errors, be sure the distance between monitors and diskette drives is at least 76 mm (3 in.). 3. Run diskette drive diagnostics. 4. Cable. 5. Diskette drive. 6. System board.

Note: See “System” on page 114 to determine which components a field service technician should replace.	
Expansion enclosure problems	
Symptom	FRU/action
The SCSI expansion enclosure used to work but does not work now.	<ol style="list-style-type: none"> 1. Verify that: <ul style="list-style-type: none"> • The cables for all external SCSI options are connected correctly. • The last option in each SCSI chain, or the end of the SCSI cable, is terminated correctly. • Any external SCSI option is turned on. You must turn on an external SCSI option before turning on the server. 2. For more information, see your SCSI expansion enclosure documentation.

Note: See “System” on page 114 to determine which components a field service technician should replace.	
General problems	
Symptom	FRU/action
Problems such as broken cover locks or indicator LEDs not working	Broken CRU/FRU

Note: See “System” on page 114 to determine which components a field service technician should replace.	
Hard disk drive problems	
Symptom	FRU/action
Not all drives are recognized by the hard disk drive diagnostic test (Fixed Disk test).	<ol style="list-style-type: none"> 1. Remove the first drive not recognized, and try the hard disk drive diagnostic test again. 2. If the remaining drives are recognized, replace the drive you removed with a new one.
System stops responding during hard disk drive diagnostic test.	<ol style="list-style-type: none"> 1. Remove the hard disk drive being tested when the server stopped responding, and try the diagnostic test again. 2. If the hard disk drive diagnostic test runs successfully, replace the drive you removed with a new one.

Note: See “System” on page 114 to determine which components a field service technician should replace.

Intermittent problems

Symptom	FRU/action
A problem occurs only occasionally and is difficult to detect.	<ol style="list-style-type: none">Verify that:<ul style="list-style-type: none">All cables and cords are connected securely to the rear of the server and attached options.When the server is turned on, air is flowing from the rear of the server at the fan grill. If there is no airflow, the fan is not working. This causes the server to overheat and shut down.Ensure that the SCSI bus and devices are configured correctly and that the last external device in each SCSI chain is terminated correctly.Check the system-error log.

Note: See “System” on page 114 to determine which components a field service technician should replace.

Keyboard, mouse, or pointing-device problems

Symptom	FRU/action
All or some keys on the keyboard do not work.	<ol style="list-style-type: none">Verify that:<ul style="list-style-type: none">The keyboard cable is securely connected to the server, and the keyboard and mouse cables are not reversed.Both the server and the monitor are turned on.Keyboard.System board.
The mouse or pointing device does not work.	<ol style="list-style-type: none">Verify that:<ul style="list-style-type: none">The mouse or pointing-device cable is securely connected, and that the keyboard and mouse cables are not reversed.The mouse device drivers are installed correctly.Both the server and the monitor are turned on.Mouse or pointing device.System board.

Note: See “System” on page 114 to determine which components a field service technician should replace.

Memory problems	
Symptom	FRU/action
The amount of system memory displayed is less than the amount of physical memory installed.	<ol style="list-style-type: none">Verify that:<ul style="list-style-type: none">The memory modules are seated properly.You have installed the correct type of memory.If you changed the memory, you updated the memory configuration with the Configuration/Setup Utility program.All banks of memory on the DIMMs are enabled. The server might have automatically disabled a DIMM bank when it detected a problem or a DIMM bank could have been manually disabled.Check POST error log for error message 289:<ul style="list-style-type: none">If the DIMM was disabled by a system-management interrupt (SMI), replace the DIMM.If the DIMM was disabled by the user or by POST:<ol style="list-style-type: none">Start the Configuration/Setup Utility program.Enable the DIMM.Save the configuration and restart the server.DIMM.System board.

Note: See “System” on page 114 to determine which components a field service technician should replace.

Microprocessor problems	
Symptom	FRU/action
The server emits a continuous tone during POST. (The startup (boot) microprocessor is not working properly.)	<ol style="list-style-type: none">Verify that the startup microprocessor is seated properly.Startup microprocessor.

Note: See “System” on page 114 to determine which components a field service technician should replace.

Monitor problems

Symptom	FRU/action
Testing the monitor.	See the information that comes with the monitor for adjusting and testing instructions. (Some IBM monitors have their own self-tests.)
The screen is blank.	<ol style="list-style-type: none"> 1. Verify that: <ul style="list-style-type: none"> • The server power cord is plugged into the server and a working electrical outlet. • The monitor cables are connected properly. • The monitor is turned on and the Brightness and Contrast controls are adjusted correctly. • If the servers are C2T chained together, verify that: <ul style="list-style-type: none"> – The C2T chain cables are securely connected to the servers. – The C2T breakout cable is connected properly. – A server that is turned on is selected. <p>Important: In some memory configurations, the 3-3-3 beep code might sound during POST followed by a blank display screen. If this occurs and the Boot Fail Count feature in the Start Options of the Configuration/Setup Utility program is set to Enabled (its default setting), you must restart the server three times to force the system BIOS code to reset the CMOS values to the default configuration (memory connector or bank of connectors enabled).</p> 2. If you have verified these items and the screen remains blank, replace: <ol style="list-style-type: none"> a. Monitor b. Video adapter, if installed c. System board
Only the cursor appears.	See “Undetermined problems” on page 110.
The monitor works when you turn on the computer but goes blank when you start some application programs.	<ol style="list-style-type: none"> 1. Verify that: <ul style="list-style-type: none"> • The application program is not setting a display mode higher than the capability of the monitor. • The primary monitor cable is connected to the C2T device breakout cable. • You installed the necessary device drivers for the applications. 2. If you have verified these items and the screen remains blank, replace the monitor. 3. Video adapter. 4. System board.

Note: See “System” on page 114 to determine which components a field service technician should replace.

Monitor problems	
Symptom	FRU/action
The screen is wavy, unreadable, rolling, distorted, or has screen jitter.	<ol style="list-style-type: none"> If the monitor self-tests show the monitor is working properly, consider the location of the monitor. Magnetic fields around other devices (such as transformers, appliances, fluorescent lights, and other monitors) can cause screen jitter or wavy, unreadable, rolling, or distorted screen images. If this happens, turn off the monitor. (Moving a color monitor while it is turned on might cause screen discoloration.) Then move the device and the monitor at least 305 mm (12 in.) apart. Turn on the monitor. Notes: <ol style="list-style-type: none"> To prevent diskette drive read/write errors, be sure the distance between monitors and diskette drives is at least 76 mm (3 in.). Non-IBM monitor cables might cause unpredictable problems. An enhanced monitor cable with additional shielding is available for the 9521 and 9527 monitors. For information about the enhanced monitor cable, contact your IBM reseller or IBM marketing representative. Monitor. Video adapter, if installed. System board.
Wrong characters appear on the screen.	<ol style="list-style-type: none"> If the wrong language is displayed, update the BIOS code with the correct language. Monitor. Video adapter, if installed. System board.
No video.	<ol style="list-style-type: none"> Make sure the correct machine is selected, if applicable. Make sure all cables are locked down.

Note: See “System” on page 114 to determine which components a field service technician should replace.	
Option problems	
Symptom	FRU/action
An IBM option that was just installed does not work.	<ol style="list-style-type: none"> Verify that: <ul style="list-style-type: none"> The option is designed for the server (see the ServerProven® list on the World Wide Web at http://www.ibm.com/pc/compat/). You followed the installation instructions that came with the option. The option is installed correctly. You have not loosened any other installed options or cables. You updated the configuration information in the Configuration/Setup Utility program. Whenever memory or an option is changed, you must update the configuration. Option you just installed.
An IBM option that used to work does not work now.	<ol style="list-style-type: none"> Verify that all of the option hardware and cable connections are secure. If the option comes with its own test instructions, use those instructions to test the option. If the failing option is a SCSI option, verify that: <ul style="list-style-type: none"> The cables for all external SCSI options are connected correctly. The last option in each SCSI chain, or the end of the SCSI cable, is terminated correctly. Any external SCSI option is turned on. You must turn on an external SCSI option before turning on the server. Failing option.

Note: See “System” on page 114 to determine which components a field service technician should replace.	
Power problems	
Symptom	FRU/action
Power switch does not work and reset button, if supported, does work.	<ol style="list-style-type: none"> Reseat connector. Power switch card. System board.
The server does not turn on.	<ol style="list-style-type: none"> Verify that: <ul style="list-style-type: none"> The power cables are properly connected to the server. The electrical outlet functions properly. The type of memory installed is correct. If you just installed an option, remove it, and restart the server. If the server now turns on, you might have installed more options than the power supply supports. Override front panel power button: <ol style="list-style-type: none"> Disconnect server power cords. Reconnect power cords. <p>If server turns on: Operator information panel</p> <p>If server does not turn on: System board</p> See “Undetermined problems” on page 110.

Note: See “System” on page 114 to determine which components a field service technician should replace.	
Power problems	
Symptom	FRU/action
The server does not turn off.	<ol style="list-style-type: none"> 1. Verify whether you are using an ACPI or non-ACPI operating system. If you are using a non-ACPI operating system: <ol style="list-style-type: none"> a. Press Ctrl+Alt+Delete. b. Turn off the system by holding the power-control button for 4 seconds. c. If server fails during BIOS POST and power-control button does not work, remove the ac power cord. 2. If the problem remains or if you are using an ACPI-aware operating system, suspect the system board.

Note: See “System” on page 114 to determine which components a field service technician should replace.	
Serial port problems	
Symptom	FRU/action
The number of serial ports identified by the operating system is less than the number of serial ports installed.	<ol style="list-style-type: none"> 1. Verify that: <ul style="list-style-type: none"> • Each port is assigned a unique address by the Configuration/Setup Utility program, and none of the serial ports is disabled. • The serial-port adapter, if you installed one, is seated properly. 2. Failing serial port adapter.
A serial device does not work. For more information about the serial port, see “Serial port” on page 75.	<ol style="list-style-type: none"> 1. Verify that: <ul style="list-style-type: none"> • The device is compatible with the server. • The serial port is enabled and is assigned a unique address. • The device is connected to the correct port (see “Input/output ports” on page 72). 2. Failing serial device. 3. Serial adapter, if installed. 4. System board.

Note: See “System” on page 114 to determine which components a field service technician should replace.	
Software problem	
Symptom	FRU/action
Suspected software problem.	<ol style="list-style-type: none"> 1. To determine if problems are caused by the software, verify that: <ul style="list-style-type: none"> • The server has the minimum memory needed to use the software. For memory requirements, see the information that comes with the software. Note: If you have just installed an adapter or memory, you might have a memory address conflict. • The software is designed to operate on the server. • Other software works on the server. • The software that you are using works on another server. <p>If you received any error messages when using the software program, see the information that comes with the software for a description of the messages and suggested solutions to the problem.</p> 2. If you have verified these items and the problem remains, contact your place of purchase.

Note: See “System” on page 114 to determine which components a field service technician should replace.	
Universal Serial Bus (USB) port problems	
Symptom	FRU/action
A USB device does not work.	<p>Verify that:</p> <ul style="list-style-type: none"> You are not trying to use a USB device during POST if you have a standard (non-USB) keyboard attached to the keyboard port. <p>Note: If a standard (non-USB) keyboard is attached to the keyboard port, the USB is disabled and no USB device will work during POST.</p> <ul style="list-style-type: none"> The correct USB device driver is installed. The operating system supports USB devices.

Power-supply LED errors

Use the information in this section to solve power-supply problems.

Note: The minimum configuration required for the dc good light to be lit is:

- Power supply
- Power cage assembly.
- System board (set switch 3 of SW1 to bypass the power switch; see “System-board switches and jumpers” on page 46).

Note: See “System” on page 114 to determine which components a field service technician should replace.			
AC good LED	DC good LED	Description	FRU/action
Off	Off	No power to system or ac problem.	<ol style="list-style-type: none"> Check ac power to the system. Disconnect the ribbon cable from connector J25 on the system board. If the ac power LED comes on, see “Undetermined problems” on page 110. Power supply.
On	Off	Standby mode or dc problem.	<ol style="list-style-type: none"> Check system board cable connectors J4 and J10. Move switch 3 of SW 1 to bypass power control. If the dc good LED is lit, press Ctrl+Alt+Delete. Watch the screen for any POST errors. Check the system-error log for any listed problems. If the system starts with no errors: <ol style="list-style-type: none"> Power switch assembly System board Remove the adapters, and disconnect the cables and power connectors to all internal and external devices. Turn on the system. If the dc good LED is lit, replace the adapters and devices one at a time until you isolate the problem. Power supply. Power cage assembly. System board.
On	On	Power is working properly.	N/A

POST error codes

In the following error codes, X can be any number or letter.

Note: See "System" on page 114 to determine which components a field service technician should replace.	
Error code/symptom	FRU/action
062 (Three consecutive startup failures using the default configuration.)	<ol style="list-style-type: none"> 1. Run the Configuration/Setup Utility program. 2. Battery. 3. System board. 4. Microprocessor.
101, 102 (System and processor error)	System board
106 (System and processor error)	System board
111 (Channel check error)	<ol style="list-style-type: none"> 1. Memory DIMM 2. System board
114 (Adapter read-only memory error)	<ol style="list-style-type: none"> 1. Failing adapter. 2. Run diagnostics.
129 (Internal cache error)	<ol style="list-style-type: none"> 1. Microprocessor 2. Optional microprocessor (if installed)
151 (Real time clock error)	<ol style="list-style-type: none"> 1. Run diagnostics. 2. Battery. 3. System board.
161 (Real time clock battery error)	<ol style="list-style-type: none"> 1. Run the Configuration/Setup Utility program. 2. Battery. 3. System board.
162 (Device configuration error) Note: Be sure to load the default settings and any additional desired settings; then, <i>save the configuration.</i>	<ol style="list-style-type: none"> 1. Run the Configuration/Setup Utility program. 2. Battery. 3. Failing device. 4. System board.
163 (Real-time clock error)	<ol style="list-style-type: none"> 1. Run the Configuration/Setup Utility program. 2. Battery. 3. System board.
164 (Memory configuration changed.)	<ol style="list-style-type: none"> 1. Run the Configuration/Setup Utility program. 2. DIMM. 3. System board.
175 (Hardware error)	System board
176 (Computer cover or cable cover was removed without a key being used)	<ol style="list-style-type: none"> 1. Run the Configuration/Setup Utility program. 2. System board.
177, 178 (Security hardware error)	<ol style="list-style-type: none"> 1. Run the Configuration/Setup Utility program. 2. System board.
184 (Power-on password damaged)	<ol style="list-style-type: none"> 1. Run the Configuration/Setup Utility program. 2. System board.

Note: See “System” on page 114 to determine which components a field service technician should replace.

Error code/symptom	FRU/action
185 (Drive startup sequence information corrupted)	<ol style="list-style-type: none"> 1. Run the Configuration/Setup Utility program. 2. System board.
186 (Security hardware control logic failed)	<ol style="list-style-type: none"> 1. Run the Configuration/Setup Utility program. 2. System board.
187 (VPD serial number not set.)	<ol style="list-style-type: none"> 1. Set serial number in the Configuration/Setup Utility program. 2. System board.
188 (Bad EEPROM CRC #2)	<ol style="list-style-type: none"> 1. Run the Configuration/Setup Utility program. 2. System board.
189 (An attempt was made to access the server with invalid passwords)	Run the Configuration/Setup Utility program, and type the administrator password.
201 (Memory test error.) If the server does not have the latest level of BIOS installed, update the BIOS to the latest level and run the diagnostic program again.	<ol style="list-style-type: none"> 1. DIMM 2. System board
229 (Cache error)	<ol style="list-style-type: none"> 1. Microprocessor 2. Optional microprocessor (if installed)
262 (DRAM parity configuration error)	<ol style="list-style-type: none"> 1. Run the Configuration/Setup Utility program. 2. Battery. 3. System board.
289 (DIMM disabled by POST or user)	<ol style="list-style-type: none"> 1. Run the Configuration/Setup Utility program, if the DIMM was disabled by the user. 2. Disabled DIMM, if not disabled by user.
301 (Keyboard or keyboard controller error)	<ol style="list-style-type: none"> 1. Keyboard 2. System board
303 (Keyboard controller error)	System board
602 (Invalid diskette boot record)	<ol style="list-style-type: none"> 1. Diskette 2. Diskette drive 3. Cable 4. System board
604 (Diskette drive error)	<ol style="list-style-type: none"> 1. Run the Configuration/Setup Utility program and diagnostics. 2. Diskette drive. 3. Drive cable. 4. System board.
605 (Unlock failure)	<ol style="list-style-type: none"> 1. Diskette drive 2. Drive cable 3. System board

Note: See “System” on page 114 to determine which components a field service technician should replace.

Error code/symptom	FRU/action
662 (Diskette drive configuration error)	<ol style="list-style-type: none"> 1. Run the Configuration/Setup Utility program and diagnostics. 2. Diskette drive. 3. Drive cable. 4. System board.
762 (Coprocessor configuration error)	<ol style="list-style-type: none"> 1. Run the Configuration/Setup Utility program. 2. Battery. 3. Microprocessor.
962 (Parallel port error)	<ol style="list-style-type: none"> 1. Disconnect the external cable on the parallel port. 2. Run the Configuration/Setup Utility program. 3. System board.
11XX (System board serial port 1 or 2 error)	<ol style="list-style-type: none"> 1. Disconnect the external cable on the serial port. 2. Run the Configuration/Setup Utility program. 3. System board.
1301 (I ² C cable to front panel not found)	<ol style="list-style-type: none"> 1. Cable 2. Front panel 3. Power switch assembly 4. System board
1302 (I ² C cable from system board to power on and reset switches not found)	<ol style="list-style-type: none"> 1. Cable 2. Power switch assembly 3. System board
1303 (I ² C cable from system board to power backplane not found)	<ol style="list-style-type: none"> 1. Cable 2. Power-cage assembly 3. System board
1304 (I ² C cable to diagnostic LED board not found)	<ol style="list-style-type: none"> 1. Power switch assembly 2. System board
1600 (The system management processor is not functioning) Complete the following steps before replacing a FRU: <ol style="list-style-type: none"> 1. Ensure that a jumper is not installed on J34. 2. Remove the ac power to the server, wait 20 seconds; then, reconnect the ac power. Wait 30 seconds; then, turn on the server. 	System board

Note: See “System” on page 114 to determine which components a field service technician should replace.

Error code/symptom	FRU/action
<p>1601 (The system is able to communicate to the system management processor, but the system management processor failed to respond at the start of POST.) Complete the following steps before replacing a FRU:</p> <ol style="list-style-type: none"> 1. Remove the ac power to the server, wait 20 seconds; then, reconnect the ac power. Wait 30 seconds; then, turn on the server. 2. Flash update the system management processor. 	<ol style="list-style-type: none"> 1. Remote Supervisor Adapter, if installed 2. System board
<p>1602 (Cable for optional service processor adapter not installed)</p>	<p>Disconnect all server and option power cords from server, wait 30 seconds, reconnect, and retry.</p>
<p>1762 (Hard disk configuration error)</p>	<ol style="list-style-type: none"> 1. Hard disk drive. 2. Hard disk cables. 3. Run the Configuration/Setup Utility program. 4. Hard disk adapter. 5. SCSI backplane. 6. System board.
<p>178X (Fixed disk error)</p>	<ol style="list-style-type: none"> 1. Hard disk cables. 2. Run diagnostics. 3. Hard disk adapter. 4. Hard disk drive. 5. System board.
<p>1800 (No more hardware interrupt available for PCI adapter)</p>	<ol style="list-style-type: none"> 1. Run the Configuration/Setup Utility program. 2. Failing adapter. 3. System board.
<p>1962 (Drive does not contain a valid boot sector)</p>	<ol style="list-style-type: none"> 1. Verify that a startable operating system is installed. 2. Run diagnostics. 3. Hard disk drive. 4. SCSI backplane. 5. Cable. 6. System board.
<p>2400 (Video controller test failure)</p>	<ol style="list-style-type: none"> 1. Video adapter (if installed) 2. System board
<p>2462 (Video memory configuration error)</p>	<ol style="list-style-type: none"> 1. Video adapter (if installed) 2. System board

Note: See “System” on page 114 to determine which components a field service technician should replace.

Error code/symptom	FRU/action
5962 (IDE CD-ROM drive configuration error)	<ol style="list-style-type: none"> 1. Run the Configuration/Setup Utility program. 2. CD-ROM drive. 3. CD-ROM power cable. 4. IDE cable. 5. System board. 6. Battery.
8603 (Pointing-device error)	<ol style="list-style-type: none"> 1. Pointing device 2. System board
0001200 (Machine check architecture error)	<ol style="list-style-type: none"> 1. Microprocessor 1 2. Optional microprocessor 2
00012000 (Microprocessor machine check)	<ol style="list-style-type: none"> 1. Microprocessor 2. System board
00019501 (Microprocessor 1 is not functioning - check VRM and microprocessor LEDs)	<ol style="list-style-type: none"> 1. VRM 1 2. Microprocessor 1 3. System board
00019502 (Microprocessor 2 is not functioning - check VRM and microprocessor LEDs)	<ol style="list-style-type: none"> 1. VRM 2 2. Microprocessor 2
00019701 (Microprocessor 1 failed)	<ol style="list-style-type: none"> 1. Microprocessor 1 2. System board
00019702 (Microprocessor 2 failed)	<ol style="list-style-type: none"> 1. Microprocessor 2 2. System board
00180100 (A PCI adapter has requested memory resources that are not available.)	<ol style="list-style-type: none"> 1. Reorder the adapters in the PCI slots. It is important that your startup device is positioned early in the startup-device order so that it is run by POST. 2. Ensure that the PCI adapter and all other adapters are set correctly in the Configuration/Setup Utility program Utility program. If the memory resource settings are not correct, change the settings. 3. If all memory resources are being used, you might need to remove an adapter to make memory available to the PCI adapter. Disabling the adapter BIOS on the adapter might correct the error. (See the documentation provided with the adapter.)
00180200 (No more I/O space available for PCI adapter)	<ol style="list-style-type: none"> 1. Run the Configuration/Setup Utility program. 2. Failing adapter. 3. System board.
00180300 (No more memory (above 1MB for PCI adapter))	<ol style="list-style-type: none"> 1. Run the Configuration/Setup Utility program. 2. Failing adapter. 3. System board.
00180400 (No more memory (below 1MB for PCI adapter))	<ol style="list-style-type: none"> 1. Run the Configuration/Setup Utility program. 2. Move the failing adapter to slot 1. 3. Failing adapter. 4. System board.

Note: See “System” on page 114 to determine which components a field service technician should replace.	
Error code/symptom	FRU/action
00180500 (PCI option ROM checksum error)	<ol style="list-style-type: none"> 1. Remove failing PCI card. 2. System board.
00180600 (PCI to PCI bridge error)	<ol style="list-style-type: none"> 1. Run the Configuration/Setup Utility program. 2. Move the failing adapter to slot 1. 3. Failing adapter. 4. System board
00180700, 00180800 (General PCI error)	<ol style="list-style-type: none"> 1. System board 2. PCI card
00181000 (PCI error)	<ol style="list-style-type: none"> 1. Adapter 2. System board
01295085 (ECC checking hardware test error)	<ol style="list-style-type: none"> 1. System board 2. Microprocessor
01298001 (No update data for microprocessor 1)	<ol style="list-style-type: none"> 1. Ensure all processors have the same cache size. 2. Microprocessor 1.
01298002 (No update data for microprocessor 2)	<ol style="list-style-type: none"> 1. Ensure all microprocessors have the same cache sizes, clock speeds and clock frequencies. 2. Microprocessor 2.
01298101 (Bad update data for microprocessor 1)	<ol style="list-style-type: none"> 1. Ensure all microprocessors have the same cache sizes, clock speeds and clock frequencies. 2. Microprocessor 1.
01298102 (Bad update data for microprocessor 2)	<ol style="list-style-type: none"> 1. Ensure all microprocessors have the same cache sizes, clock speeds and clock frequencies. 2. Microprocessor 2.
I9990301 (Hard disk sector error)	<ol style="list-style-type: none"> 1. Hard disk drive 2. SCSI backplane 3. Cable 4. System board
I9990305 (Hard disk sector error, no operating system installed)	Install operating system to hard disk.
I9990650 (AC power has been restored)	<ol style="list-style-type: none"> 1. Check cable. 2. Check for interruption of power. 3. Power cable.

Service processor error codes

When viewed from POST, service processor error codes will appear in hexadecimal form (generally beginning with A2, A3, A4, A5, A6, A7, AD, AE, or E1). However, when viewed from the system-error log, the messages will appear as text. To determine a possible error condition for the service processor, see the system-error log (see “Viewing error logs from diagnostic programs” on page 28).

SCSI error codes

Note: If a ServeRAID-5i controller is installed and later removed, you must re-enable the on-board SCSI controller in using the Configuration/Setup Utility program (see “Starting the Configuration/Setup Utility program” on page 11).

Error code	FRU/action
<p>All SCSI Errors One or more of the following might be causing the problem:</p> <ul style="list-style-type: none"> • A failing SCSI device (adapter, drive, controller) • An improper SCSI configuration or SCSI termination jumper setting • Duplicate SCSI IDs in the same SCSI chain • A missing or improperly installed SCSI terminator • A defective SCSI terminator • An improperly installed cable • A defective cable 	<ol style="list-style-type: none"> 1. External SCSI devices must be turned on before you turn on the server. 2. Make sure that the cables for all external SCSI devices are connected correctly. 3. If you have attached an external SCSI device to the server, make sure the external SCSI termination is set to automatic. 4. Make sure that the last device in each SCSI chain is terminated correctly. 5. Make sure that the SCSI devices are configured correctly.

Temperature error messages

Note: See “System” on page 114 to determine which components a field service technician should replace.	
Message	Action
DASD Over Temperature (level-critical; direct access storage device bay x was over temperature)	Ensure that the server is being properly cooled; see “System reliability considerations” on page 41.
DASD Over recommended Temperature (sensor x) (level-warning; hard disk drive bay x had over temperature condition)	Ensure that the server is being properly cooled; see “System reliability considerations” on page 41.
DASD under recommended temperature (sensor x) (level-warning; direct access storage device bay x had under temperature condition)	Ambient temperature must be within normal operating specifications; see “Features and specifications” on page 3.
DASD Over Temperature (level-critical; sensor for DASD1 reported temperature over recommended range)	Ensure that the server is being properly cooled; see “System reliability considerations” on page 41.
Power supply x Temperature Fault (level-critical; power supply x had over temperature condition)	<ol style="list-style-type: none"> 1. Ensure that the server is being properly cooled; see “System reliability considerations” on page 41. 2. Replace power supply x.
System board is over recommended temperature (level-warning; system board is over recommended temperature)	<ol style="list-style-type: none"> 1. Ensure that the server is being properly cooled; see “System reliability considerations” on page 41. 2. Replace the system board.
System board is under recommended temperature (level-warning; system board is under recommended temperature)	Ambient temperature must be within normal operating specifications; see “Features and specifications” on page 3.

Note: See “System” on page 114 to determine which components a field service technician should replace.	
Message	Action
System over temperature for CPU x (level-warning; CPU x reporting over temperature condition)	Ensure that the server is being properly cooled; see “System reliability considerations” on page 41.
System under recommended CPU x temperature (level-warning; system reporting under temperature condition for CPU x)	Ambient temperature must be within normal operating specifications; see “Features and specifications” on page 3.

Fan error messages

Note: See “System” on page 114 to determine which components a field service technician should replace.	
Message	Action
Fan x failure (level-critical; fan x had a failure)	<ol style="list-style-type: none"> 1. Check connections to fan x. 2. Replace fan x.
Fan x fault (level-critical; fan x beyond recommended RPM range)	<ol style="list-style-type: none"> 1. Check connections to fan x. 2. Replace fan x.
Fan x outside recommended speed action	Replace fan x.

Power error messages

Note: See “System” on page 114 to determine which components a field service technician should replace.	
Message	Action
Power supply x current share fault (level-critical; excessive current demand on power supply x)	Replace power supply x.
Power supply x DC good fault (level-critical; power good signal not detected for power supply x)	Replace power supply x.
Power supply x temperature fault	Replace power supply x.
Power supply x removed	No action required - information only.
Power supply x fan fault (level-critical; fan fault in power supply x)	Replace power supply x.
Power supply x 12 V fault (level-critical; overcurrent condition detected)	See “Power checkout” on page 37.
Power supply x 3.3 V fault (level-critical; 3.3 V power supply x had an error)	See “Power checkout” on page 37.
Power supply x 5 V fault (level-critical; 5 V power supply x had an error)	See “Power checkout” on page 37.
System running non-redundant power (level-noncritical; system does not have redundant power)	<ol style="list-style-type: none"> 1. Add another power supply. 2. Remove options from server. 3. System can continue to operate without redundancy protection if steps 1 and 2 are not followed.

Note: See “System” on page 114 to determine which components a field service technician should replace.	
Message	Action
System under recommended voltage for x (level-warning; indicated voltage supply under nominal value; value for x can be +12, -12, or +5)	<ol style="list-style-type: none"> 1. Check connections to the power subsystem. 2. Power supply. 3. Power cage assembly.

System shutdown

Refer to the following tables when experiencing system shutdown related to voltage or temperature problems.

Voltage related system shutdown

Note: See “System” on page 114 to determine which components a field service technician should replace.	
Message	Action
System shutoff due to x current over max value (level-critical; system drawing too much current on voltage x bus)	See “Power checkout” on page 37.
System shutoff due to x V over voltage (level-critical; system shutoff due to x supply over voltage)	<ol style="list-style-type: none"> 1. Check the power-supply connectors. 2. Power supply. 3. Power cage assembly.
System shutoff due to x V under voltage (level-critical system shutoff due to x supply under voltage)	<ol style="list-style-type: none"> 1. Check the power-supply connectors. 2. Power supply. 3. Power cage assembly.
System shutoff due to VRM x over voltage	Replace VRM x.
System shutoff due to excessive (< 240 VA) loading	<ol style="list-style-type: none"> 1. See “Power checkout” on page 37. 2. Cycle ac on/off.

Temperature related system shutdown

Note: See “System” on page 114 to determine which components a field service technician should replace.	
Message	Action
System shutoff due to board over temperature (level-critical; board is over temperature)	<ol style="list-style-type: none"> 1. Ensure that the server is being properly cooled; see “System reliability considerations” on page 41. 2. Replace board.
System shutoff due to CPU x over temperature (level-critical; CPU x is over temperature)	<ol style="list-style-type: none"> 1. Ensure that the server is being properly cooled; see “System reliability considerations” on page 41. 2. Replace CPU x.
System shutoff due to CPU x under temperature (level-critical; CPU x is under temperature)	Ambient temperature must be within normal operating specifications; see “Features and specifications” on page 3.
System shutoff due to DASD temperature (sensor x) (level-critical; DASD area reported temperature outside recommended operating range)	Ensure that the system is being properly cooled; see “System reliability considerations” on page 41.

Note: See “System” on page 114 to determine which components a field service technician should replace.	
Message	Action
System shutoff due to high ambient temperature (level-critical; high ambient temperature)	Ambient temperature must be within normal operating specifications; see “Features and specifications” on page 3.
System shutoff due to system board under temperature (level-critical; system board is under temperature)	Ambient temperature must be within normal operating specifications; see “Features and specifications” on page 3.

Hard disk drive checkout

Note: See “System” on page 114 to determine which components a field service technician should replace.	
Message	Action
Hard drive x removal detected (level-critical; hard drive x has been removed)	Information only, take action as appropriate.

Host built-in self test (BIST)

Note: See “System” on page 114 to determine which components a field service technician should replace.	
Message	Action
Host fail (level-informational; built-in self-test for the host failed)	<ol style="list-style-type: none"> 1. Reseat the microprocessor. 2. Reseat the VRM. 3. Microprocessor.

Bus fault messages

Note: See “System” on page 114 to determine which components a field service technician should replace.	
Bus fault messages	Message Action
Failure reading 12C device. Check devices on bus 0.	<ol style="list-style-type: none"> 1. If installed, reseat the I2C cable between Remote Supervisor Adapter (in PCI slot 5/J5 on the PCI riser card) and the Remote Supervisor Adapter connector on the PCI riser card. 2. Memory DIMMs. 3. System board.
Failure reading 12C device. Check devices on bus 1.	<ol style="list-style-type: none"> 1. Reseat the I2C cable between the operator information panel and system board (J22). 2. Operator information panel. 3. System board.
Failure reading 12C device. Check devices on bus 2.	<ol style="list-style-type: none"> 1. Reseat the cable between system board and the power supply (power cage assembly) (J10). 2. Power cage assembly. 3. Power supply. 4. System board.

Note: See "System" on page 114 to determine which components a field service technician should replace.	
Bus fault messages	Message Action
Failure reading 12C device. Check devices on bus 3.	<ol style="list-style-type: none"> 1. Reseat the cable between the hard disk drive backplane and connector (J10) of system board. 2. Hard disk drive backplane. 3. System board.
Failure reading I2C device. Check device on bus 4.	System board

Undetermined problems

Use the information in this section if the diagnostic tests did not identify the failure, the devices list is incorrect, or the system is inoperative.

Notes:

1. Damaged data in CMOS can cause undetermined problems.
2. Damaged data in BIOS code can cause undetermined problems.

Check the LEDs on all the power supplies. If the LEDs indicate the power supplies are working correctly, complete the following steps:

1. Turn off the server.
2. Be sure the server is cabled correctly.
3. Remove or disconnect the following devices (one at a time) until you find the failure (turn on the server and reconfigure each time):

Any external devices

Surge suppressor device (on the server)

Modem, printer, mouse, or non-IBM devices

Each adapter

Drives

Memory modules (minimum requirement = 256 MB (2 banks of 128 MB DIMMs))

Note: Minimum operating requirements are:

- a. One power supply
 - b. Power cage assembly
 - c. System board
 - d. One microprocessor and VRM
 - e. Memory module (with a minimum of two 128 MB DIMMs)
4. Turn on the server. If the problem remains, suspect the following FRUs in the order listed:
 - Power supply
 - Power cage assembly
 - System board

Notes:

1. If the problem goes away when you remove an adapter from the system and replacing that adapter does not correct the problem, suspect the system board.
2. If you suspect a networking problem and all the system tests pass, suspect a network cabling problem external to the system.

Problem determination tips

Due to the variety of hardware and software combinations that can be encountered, use the following information to assist you in problem determination. If possible, have this information available when requesting assistance from Service Support and Engineering functions.

- Machine type and model
- Microprocessor or hard disk upgrades
- Failure symptom
 - Do diagnostics fail?
 - What, when, where, single, or multiple systems?
 - Is the failure repeatable?
 - Has this configuration ever worked?
 - If it has been working, what changes were made prior to it failing?
 - Is this the original reported failure?
- Diagnostics version — type and version level
- Hardware configuration
 - Print (print screen) configuration currently in use
 - BIOS level
- Operating system software type and version level

Note: To eliminate confusion, identical systems are considered identical only if they:

1. Are the exact machine type and models
2. Have the same BIOS level
3. Have the same adapters/attachments in the same locations
4. Have the same address jumpers/terminators/cabling
5. Have the same software versions and levels
6. Have the same diagnostics code (version)
7. Have the same configuration options set in the system
8. Have the same setup for the operation system control files

Comparing the configuration and software set-up between "working" and "non-working" systems will often lead to problem resolution.

Chapter 7. Parts listing xSeries 345 Type 8670

This parts listing supports the xSeries 345 Type 8670.

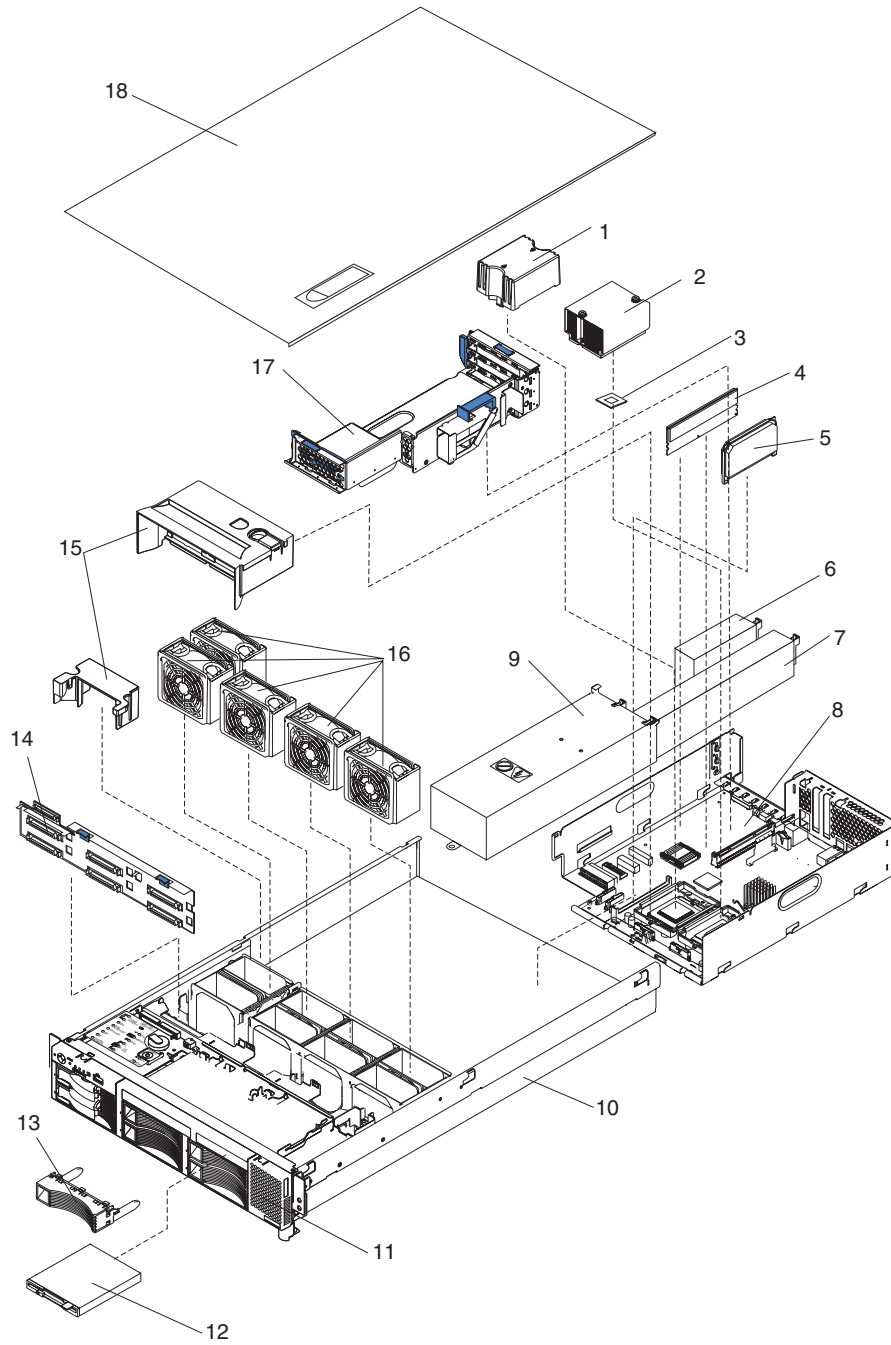

System

Note: Field replaceable units (FRUs) must be serviced only by qualified field service technicians. Customer replaceable units (CRUs) can be replaced by the customer.

Index	Server (xSeries 345, Type 8670) Models 11X, 12X, 21X, 22X, 23X, 24X, 31X, 32X, 3PX, 3WX, 3YX, 3ZX, 51X, 52X, 61X, 62X, 71X, 72X, 7RG, 91X, G1X	FRU No.	CRU/FRU
1	Microprocessor air baffle (models 11X, 12X, 21X, 22X, 31X, 32X, 3PX, 3WX, 3YX, 3ZX, 51X, 52X, 61X, 62X, 71X, 72X, 7RG, 91X, G1X)	24P1284	CRU
2	Heat-sink assembly, microprocessor (all models)	25P6309	FRU
3	Microprocessor, 2.0 GHz (models 11X, 12X)	25P2671	FRU
3	Microprocessor, 2.2 GHz (models 21X, 22X, 23X)	32P8582	FRU
3	Microprocessor, 2.4 GHz (models 24X, 31X, 32X)	37L3570	FRU
3	Microprocessor, 2.4 GHz (models 3PX, 3WX, 3YX, 3ZX)	59P4937	FRU
3	Microprocessor, 2.67 GHz (models 51X, 52X)	59P4840	FRU
3	Microprocessor, 2.8 GHz (models 61X, 62X)	59P4845	FRU
a3	Microprocessor, 3.0 GHz (models 71X, 72X, 7RX)	71P8340	FRU
3	Microprocessor, 3.0 GHz (models 91X, 9RX)	88P9782	FRU
3	Microprocessor, 3.2 GHz (model G1X)	90P0969	FRU
4	Memory, 256 PC2100 ECC (models 11X, 12X, 21X, 22X, 31X, 32X, 3WX, 51X, 52X, 61X, 62X, 71X, 72X, 91X, G1X)	09N4306	CRU
4	Memory, 512 MB PC2100 ECC (models 23X, 3PX, 3YX, 3ZX)	09N4307	CRU
4	Memory, 1 GB PC2100 ECC (model 24X)	09N4308	CRU
5	VRM card 9.05P (models 11x, 12x, 21x, 22x, 23x, 24x, 31x, 32x)	49P2129	FRU
5	VRM card 9.1 (models 51x, 52x, 61x, 62x, 71x, 72x, 7RG, 91X, 9RX, G1X)	49P2010	FRU
6	Power-supply filler panel (models 11X, 21X, 31X)	01R0601	CRU
6	Power-supply filler panel (models 71x, 91X, G1X)	73P6163	CRU
7	Hot-swap power supply, 350 watt (models 11x, 21x, 31x, 51x, 61x, 12x, 22x, 23x, 24x, 32x, 52x, 62x)	49P2033	CRU
7	Hot-swap power supply, 514 watt (models 71X, 91X, G1X, 72X, 7RG, 9RX)	49P2167	CRU
8	System board shuttle assembly (models 11X, 12X, 21X, 22X, 23X, 24X, 31X, 32X)	23K4454	FRU
8	System board shuttle assembly (models 3PX, 3WX, 3YX, 3ZX, 51X, 52X, 61X, 62X)	23K4455	FRU
8	System board shuttle assembly (models 71X, 72X, 7RG, 91X, 9RX, G1X)	23K4456	FRU
9	Power cage assembly (models 11X, 12X, 21X, 22X, 23X, 24X, 31X, 32X, 51X, 52X, 61X, 62x)	49P2037	FRU
9	Power cage assembly (models 71X, 72X, 7RG, 91X, 9RX, G1X)	49P2169	FRU
10	Chassis (models 11X, 12X, 21X, 22X, 31X, 32X, 3PX, 3WX, 3YX, 3ZX, 51X, 52X, 61X, 62X, 91X, G1X)	01R0588	FRU
10	Chassis (models 71X, 72X, 7RG, 91X, 9RX, G1X)	73P6161	FRU
11	Front bezel assembly (models 11X, 12X, 21X, 22X, 31X, 32X, , 51X, 52X, 61X, 62X, 71X, 72X, 91X, G1X)	32P1878	CRU
11	Front bezel assembly (model 23X)	01R0664	CRU
11	Front bezel assembly (model 24X)	01R0682	CRU
11	Front bezel assembly (models 3PX, 3WX, 3YX, 3ZX)	73P6635	CRU
12	Hard disk drive, 36 GB (models 12X, 22X, 32X)	06P5778	CRU
12	Hard disk drive, 36 GB (models 3YX, 3ZX)	90P1341	CRU
12	Hard disk drive, 36 GB (models 52X, 62X, 72X, 7RG, 9RX)	32P0729	CRU
12	Hard disk drive, 73 GB (model 3ZX)	90P1340	CRU
12	Hard disk drive, 73 GB (models 23X, 24X)	32P0759	CRU

Server (xSeries 345, Type 8670) Models 11X, 12X, 21X, 22X, 23X, 24X, 31X, 32X, 3PX, 3WX, 3YX, 3ZX, 51X, 52X, 61X, 62X, 71X, 72X, 7RG, 91X, G1X		FRU No.	CRU/FRU
Index			
13	Blank bezel, hard disk drive (all models)	00N7259	CRU
14	Hard disk drive backplane with bracket assembly (all models)	59P5856	FRU
15	Thermal baffle kit (all models)	01R0614	FRU
16	Fan assembly, 80-mm hot-swap (all models)	01R0587	CRU
17	PCI riser card assembly (models 11X, 12X, 21X, 22X, 23X, 24X, 31X, 32X, 3PX, 3WX, 3YX, 3ZX, 51X, 52X, 61X, 62X)	48P9027	FRU
17	PCI riser card assembly (model 71X, 72X, 7RG, 91X, 9RX, G1X)	73P6591	FRU
18	Top cover (models 11X, 12X, 21X, 22X, 31X, 32X, 3PX, 3WX, 3YX, 3ZX, 51X, 52X, 61X, 62X, 91X, G1X)	01R0595	CRU
18	Top cover (models 71X, 72X, 7RG, 91X, 9RX, G1X)	73P6162	CRU
	Alcohol wipe kit (all models)	59P4739	FRU
	Thermal grease kit (all models)	59P4740	FRU
	Baffle, memory DIMM (models 41X, 52X, 61X, 62X, 71X, 72X, 7RG)	90P4079	FRU
	Battery (all models)	33F8354	FRU
	Battery pack, RAID adapter (models 12X, 22X, 32X, 52X, 62X, 72X)	25P3482	FRU
	Battery pack, 3U/2U (models 7RG, 9RX)	02R0986	FRU
	Cable-IDE, 2-drop (models 23X, 24X)	01R0636	CRU
	Cable-management-arm assembly (all models)	01R0591	CRU
	Cable, SCSI signal (all models)	32P1871	CRU
	Cable, USB (all models)	32P1872	CRU
	Cable, operator information card to system board (all models)	32P1870	CRU
	Cable, hard disk drive to operator information card (models 11X, 12X, 21X, 22X, 31X, 32X, 3PX, 3WX, 3YX, 3ZX, 51X, 52X, 61X, 62X, 71X, 72X, 91X, G1X)	32P1869	CRU
	Cable, CD signal to system board (models 11X, 12X, 21X, 22X, 31X, 32X, 51X, 52X, 61X, 62X)	32P1874	CRU
	Cable, fan 2 drop (all models)	32P1873	FRU
	Cable, power 2 drop y cable (models 23x, 24x)	01R0638	FRU
	CD-ROM drive, 24X, primary (all models)	06P5263	CRU
	CD-ROM drive, 24X, alternate (all models)	19K1523	CRU
	CD-ROM drive, 24X, alternate (all models)	33P3231	CRU
	Cord, 2.1M jumper (models 11X, 12X, 21X, 22X, 23X, 24X, 31X, 32X, 51X, 52X, 61X, 62X, 71X, 72X, 7RG, 91X, G1X)	36L8886	CRU
	Diskette drive, slim high (models 11X, 12X, 21X, 22X, 31X, 32X, 3PX, 3WX, 3YX, 3ZX, 51X, 52X, 61X, 62X, 71X, 72X, 7RG, 91X, G1X)	36L8645	CRU
	DVD 8X slim high (models 3PX, 3WX, 3YX, 3ZX)	24P3637	CRU
	EIA bracket assembly (all models)	01R0593	FRU
	Flash card (models 23X, 24X)	59P6057	FRU
	Flash mounting bracket (models 23X, 24X)	01R0672	FRU
	Filler bezel, blue (models 23X, 3PX, 3WX, 3YX)	32P1267	FRU
	Interposer card (models 23X, 24X)	59P6054	FRU
	Interposer card (all models)	48P9028	FRU

Index	FRU No.	CRU/FRU
Server (xSeries 345, Type 8670) Models 11X, 12X, 21X, 22X, 23X, 24X, 31X, 32X, 3PX, 3WX, 3YX, 3ZX, 51X, 52X, 61X, 62X, 71X, 72X, 7RG, 91X, G1X		
Mechanical miscellaneous parts kit (models 11X 12X 21X 22X 31X 32X 3PX, 3WX, 3YX, 3ZX, 51X 52X 61X 62X 91X G1X)	01R0589	FRU
<ul style="list-style-type: none"> • Clip, VRM Metal (2) • Filler, Standard PCI Blank (3) • Filler, Low Profile PCI Blank (2) • Latch, Standard PCI Retention (2) • Guide, PCI Card (3) • Latch, Shuttle Locking (2) • Spring, Shuttle Latch (2) • Latch, Low Profile PCI Retention (3) • Lid, Low Profile PCI Retention (2) • Latch, PCI Cage Retention (2) • Light Box, Switch Card (1) • Latch, Cable Strain Relief (2) • Holder, FDD Wire Spring (2) • Holder, CD Wire Spring (2) • Latch, HDD Backplane Retention (3) • Screw, M3.5x5 (17) • Screw, M3.5x10 (10) • Screw, #4-40 standoff (4) • Screw, 0.8 mm standoff (2) 		
Mechanical miscellaneous parts kit (models 71X, 72X, 7RG, 91X, 9RX, G1X)	73P6127	FRU
Operator information card (all models)	48P9029	FRU
Power cord; see "Power cords" on page 117. (all models)	6952300	CRU
RAID adapter (models 12X, 22X, 32X, 3PX, 3WX, 3YX, 3ZX, 52X, 62X, 72X)	02R0970	CRU
RAID adapter (models 7RG, 9RX)	71P8627	CRU
Retain module (models 11X, 12X, 21X, 22X, 31X, 32X)	06P6350	FRU
Retain module (models 3PX, 3WX, 3YX, 3ZX, 51X, 52X, 61X, 62X, 71X, 72X, 7RG, 91X, 9RX, G1X)	71P8107	FRU
Slide 2U left and right (models 11X, 12X, 21X, 22X, 23X, 24X, 31X, 32X, 3PX, 3WX, 3YX, 3ZX, 51X, 52X, 61X, 62X, 91X, G1X)	90P4011	CRU
Slide 2U left and right (models 71X, 72X, 7RG, 91X, 9RX)	90P4062	CRU
System service label (models 11X, 12X, 21X, 22X, 31X, 32X)	01R0594	FRU
System service label (models 23X, 24X, 3PX, 3WX, 3YX, 3ZX)	01R0667	FRU
System service label (models 51X, 52X, 61X, 62X)	01R1438	FRU
System service label (models 71X, 72X, 7RG, 91X, 9RX, G1X)	73P6164	FRU
VRM clip (all models)	31P6025	FRU
Cable, fan 2 drop (all models)	32P1873	FRU

Keyboard CRUs

Keyboard	CRU No.
US English	37L2551
French Canadian	37L2552
LA Spanish	37L2553
Arabic	37L2555
Belgium/French	37L2556
Belgium/UK	37L2557
Bulgarian	37L2558
Czech	37L2559

Keyboard	CRU No.
Danish	37L2560
Dutch	37L2561
French	37L2562
German	37L2563
Greek	37L2564
Hebrew	37L2565
Hungarian	37L2566
Korean	02K0901
Iceland	37L2567
Italy	37L2568
Norwegian	37L2569
Polish	37L2570
Portuguese	37L2571
Romanian	37L2572
Russian	37L2573
Serbian/Cyrillic	37L2574
Slavic	37L2575
Spanish	37L2576
Swedish/Finnish	37L2577
Swiss, French/German	37L2578
Turkish	37L2579
Turkish	37L2580
UK English	37L2581
Yugosl/Lat	37L2582
US English-EMEA	37L2583
Chinese/US	37L2585
Thailand	37L2587
French Canadian	37L0913

Power cords

For your safety, IBM provides a power cord with a grounded attachment plug to use with this IBM product. To avoid electrical shock, always use the power cord and plug with a properly grounded outlet.

IBM power cords used in the United States and Canada are listed by Underwriter's Laboratories (UL) and certified by the Canadian Standards Association (CSA).

For units intended to be operated at 115 volts: Use a UL-listed and CSA-certified cord set consisting of a minimum 18 AWG, Type SVT or SJT, three-conductor cord, a maximum of 15 feet in length and a parallel blade, grounding-type attachment plug rated 15 amperes, 125 volts.

For units intended to be operated at 230 volts (U.S. use): Use a UL-listed and CSA-certified cord set consisting of a minimum 18 AWG, Type SVT or SJT, three-conductor cord, a maximum of 15 feet in length and a tandem blade, grounding-type attachment plug rated 15 amperes, 250 volts.

For units intended to be operated at 230 volts (outside the U.S.): Use a cord set with a grounding-type attachment plug. The cord set should have the appropriate safety approvals for the country in which the equipment will be installed.

IBM power cords for a specific country or region are usually available only in that country or region.

IBM power cord part number	Used on these countries and regions
13F9940	Argentina, Australia, China (PRC), New Zealand, Papua New Guinea, Paraguay, Uruguay, Western Samoa
13F9979	Afghanistan, Algeria, Andorra, Angola, Austria, Belgium, Benin, Bulgaria, Burkina Faso, Burundi, Cameroon, Central African Rep., Chad, China (Macau S.A.R.), Czech Republic, Egypt, Finland, France, French Guiana, Germany, Greece, Guinea, Hungary, Iceland, Indonesia, Iran, Ivory Coast, Jordan, Lebanon, Luxembourg, Malagasy, Mali, Martinique, Mauritania, Mauritius, Monaco, Morocco, Mozambique, Netherlands, New Caledonia, Niger, Norway, Poland, Portugal, Romania, Senegal, Slovakia, Spain, Sudan, Sweden, Syria, Togo, Tunisia, Turkey, former USSR, Vietnam, former Yugoslavia, Zaire, Zimbabwe
13F9997	Denmark
14F0015	Bangladesh, Burma, Pakistan, South Africa, Sri Lanka
14F0033	Antigua, Bahrain, Brunei, Channel Islands, China (Hong Kong S.A.R.), Cyprus, Dubai, Fiji, Ghana, India, Iraq, Ireland, Kenya, Kuwait, Malawi, Malaysia, Malta, Nepal, Nigeria, Polynesia, Qatar, Sierra Leone, Singapore, Tanzania, Uganda, United Kingdom, Yemen, Zambia
14F0051	Liechtenstein, Switzerland
14F0069	Chile, Ethiopia, Italy, Libya, Somalia
14F0087	Israel
1838574	Thailand
6952301	Bahamas, Barbados, Bermuda, Bolivia, Brazil, Canada, Cayman Islands, Colombia, Costa Rica, Dominican Republic, Ecuador, El Salvador, Guatemala, Guyana, Haiti, Honduras, Jamaica, Japan, Korea (South), Liberia, Mexico, Netherlands Antilles, Nicaragua, Panama, Peru, Philippines, Saudi Arabia, Suriname, Taiwan, Trinidad (West Indies), United States of America, Venezuela

Appendix A. Getting help and technical assistance

If you need help, service, or technical assistance or just want more information about IBM products, you will find a wide variety of sources available from IBM to assist you. This appendix contains information about where to go for additional information about IBM and IBM products, what to do if you experience a problem with your xSeries or IntelliStation system, and whom to call for service, if it is necessary.

Before you call

Before you call, make sure that you have taken these steps to try to solve the problem yourself:

- Check all cables to make sure that they are connected.
- Check the power switches to make sure that the system is turned on.
- Use the troubleshooting information in your system documentation, and use the diagnostic tools that come with your system.
- Go to the IBM Support Web site at <http://www.ibm.com/pc/support/> to check for technical information, hints, tips, and new device drivers.
- Use an IBM discussion forum on the IBM Web site to ask questions.

You can solve many problems without outside assistance by following the troubleshooting procedures that IBM provides in the online help or in the publications that are provided with your system and software. The information that comes with your system also describes the diagnostic tests that you can perform. Most xSeries and IntelliStation systems, operating systems, and programs come with information that contains troubleshooting procedures and explanations of error messages and error codes. If you suspect a software problem, see the information for the operating system or program.

Using the documentation

Information about your IBM xSeries or IntelliStation system and preinstalled software, if any, is available in the documentation that comes with your system. That documentation includes printed books, online books, README files, and help files. See the troubleshooting information in your system documentation for instructions for using the diagnostic programs. The troubleshooting information or the diagnostic programs might tell you that you need additional or updated device drivers or other software. IBM maintains pages on the World Wide Web where you can get the latest technical information and download device drivers and updates. To access these pages, go to <http://www.ibm.com/pc/support/> and follow the instructions. Also, you can order publications through the IBM Publications Ordering System at www.elink.ibm.com/public/applications/publications/cgibin/pbi.cgi.

Getting help and information from the World Wide Web

On the World Wide Web, the IBM Web site has up-to-date information about IBM xSeries and IntelliStation products, services, and support. The address for IBM xSeries information is <http://www.ibm.com/eserver/xseries/>. The address for IBM IntelliStation information is <http://www.ibm.com/pc/intellistation/>.

You can find service information for your IBM products, including supported options, at <http://www.ibm.com/pc/support/>.

Software service and support

Through IBM Support Line, you can get telephone assistance, for a fee, with usage, configuration, and software problems with xSeries servers, IntelliStation workstations, and appliances. For information about which products are supported by Support Line in your country or region, go to <http://www.ibm.com/services/sl/products/>.

For more information about Support Line and other IBM services, go to <http://www.ibm.com/services/>, or go to <http://www.ibm.com/planetwide/> for support telephone numbers.

Hardware service and support

You can receive hardware service through IBM Integrated Technology Services or through your IBM reseller, if your reseller is authorized by IBM to provide warranty service. Go to <http://www.ibm.com/planetwide/> for support telephone numbers, or in the U.S. and Canada, call 1-800-IBM-SERV (1-800-426-7378).

In the U.S. and Canada, hardware service and support is available 24 hours a day, 7 days a week. In the U.K., these services are available Monday through Friday, from 9 a.m. to 6 p.m.

Appendix B. Related service information

Note: The service procedures are designed to help you isolate problems. They are written with the assumption that you have model-specific training on all computers, or that are familiar with the computers, functions, terminology, and service information provided in this manual.

Safety information

The following section contains the safety information that you need to be familiar with before servicing an IBM computer.

General safety

Follow these rules to ensure general safety:

- Observe good housekeeping in the area of the machines during and after maintenance.
- When lifting any heavy object:
 1. Ensure you can stand safely without slipping.
 2. Distribute the weight of the object equally between your feet.
 3. Use a slow lifting force. Never move suddenly or twist when you attempt to lift.
 4. Lift by standing or by pushing up with your leg muscles; this action removes the strain from the muscles in your back. *Do not attempt to lift any objects that weigh more than 16 kg (35 lb) or objects that you think are too heavy for you.*
- Do not perform any action that causes hazards to the customer, or that makes the equipment unsafe.
- Before you start the machine, ensure that other service representatives and the customer's personnel are not in a hazardous position.
- Place removed covers and other parts in a safe place, away from all personnel, while you are servicing the machine.
- Keep your tool case away from walk areas so that other people will not trip over it.
- Do not wear loose clothing that can be trapped in the moving parts of a machine. Ensure that your sleeves are fastened or rolled up above your elbows. If your hair is long, fasten it.
- Insert the ends of your necktie or scarf inside clothing or fasten it with a nonconductive clip, approximately 8 centimeters (3 inches) from the end.
- Do not wear jewelry, chains, metal-frame eyeglasses, or metal fasteners for your clothing.

Remember: Metal objects are good electrical conductors.
- Wear safety glasses when you are: hammering, drilling soldering, cutting wire, attaching springs, using solvents, or working in any other conditions that might be hazardous to your eyes.
- After service, reinstall all safety shields, guards, labels, and ground wires. Replace any safety device that is worn or defective.
- Reinstall all covers correctly before returning the machine to the customer.

Electrical safety



CAUTION:

Electrical current from power, telephone, and communication cables can be hazardous. To avoid personal injury or equipment damage, disconnect the attached power cords, telecommunication systems, networks, and modems before you open the server covers, unless instructed otherwise in the installation and configuration procedures.

Observe the following rules when working on electrical equipment.

Important: Use only approved tools and test equipment. Some hand tools have handles covered with a soft material that does not insulate you when working with live electrical currents.

Many customers have, near their equipment, rubber floor mats that contain small conductive fibers to decrease electrostatic discharges. Do not use this type of mat to protect yourself from electrical shock.

- Find the room emergency power-off (EPO) switch, disconnecting switch, or electrical outlet. If an electrical accident occurs, you can then operate the switch or unplug the power cord quickly.
- Do not work alone under hazardous conditions or near equipment that has hazardous voltages.
- Disconnect all power before:
 - Performing a mechanical inspection
 - Working near power supplies
 - Removing or installing main units
- Before you start to work on the machine, unplug the power cord. If you cannot unplug it, ask the customer to power-off the wall box that supplies power to the machine and to lock the wall box in the off position.
- If you need to work on a machine that has exposed electrical circuits, observe the following precautions:
 - Ensure that another person, familiar with the power-off controls, is near you.

Remember: Another person must be there to switch off the power, if necessary.
 - Use only one hand when working with powered-on electrical equipment; keep the other hand in your pocket or behind your back.

Remember: There must be a complete circuit to cause electrical shock. By observing the above rule, you may prevent a current from passing through your body.
 - When using testers, set the controls correctly and use the approved probe leads and accessories for that tester.
 - Stand on suitable rubber mats (obtained locally, if necessary) to insulate you from grounds such as metal floor strips and machine frames.

Observe the special safety precautions when you work with very high voltages; these instructions are in the safety sections of maintenance information. Use extreme care when measuring high voltages.

- Regularly inspect and maintain your electrical hand tools for safe operational condition.
- Do not use worn or broken tools and testers.
- *Never assume* that power has been disconnected from a circuit. First, *check* that it has been powered-off.

- Always look carefully for possible hazards in your work area. Examples of these hazards are moist floors, nongrounded power extension cables, power surges, and missing safety grounds.
- Do not touch live electrical circuits with the reflective surface of a plastic dental mirror. The surface is conductive; such touching can cause personal injury and machine damage.
- Do not service the following parts with the power on when they are removed from their normal operating places in a machine:
 - Power supply units
 - Pumps
 - Blowers and fans
 - Motor generators
 and similar units. (This practice ensures correct grounding of the units.)
- If an electrical accident occurs:
 - Use caution; do not become a victim yourself.
 - Switch off power.
 - Send another person to get medical aid.

Safety inspection guide

The intent of this inspection guide is to assist you in identifying potentially unsafe conditions on these products. Each machine, as it was designed and built, had required safety items installed to protect users and service personnel from injury. This guide addresses only those items. However, good judgment should be used to identify potential safety hazards due to attachment of non-IBM features or options not covered by this inspection guide.

If any unsafe conditions are present, you must determine how serious the apparent hazard could be and whether you can continue without first correcting the problem.

Consider these conditions and the safety hazards they present:

- Electrical hazards, especially primary power (primary voltage on the frame can cause serious or fatal electrical shock).
- Explosive hazards, such as a damaged CRT face or bulging capacitor
- Mechanical hazards, such as loose or missing hardware

The guide consists of a series of steps presented in a checklist. Begin the checks with the power off, and the power cord disconnected.

Checklist:

1. Check exterior covers for damage (loose, broken, or sharp edges).
2. Turn off the computer. Disconnect the power cord.
3. Check the power cord for:
 - a. A third-wire ground connector in good condition. Use a meter to measure third-wire ground continuity for 0.1 ohm or less between the external ground pin and frame ground.
 - b. The power cord should be the appropriate type as specified in the parts listings.
 - c. Insulation must not be frayed or worn.
4. Remove the cover.
5. Check for any obvious non-IBM alterations. Use good judgment as to the safety of any non-IBM alterations.
6. Check inside the unit for any obvious unsafe conditions, such as metal filings, contamination, water or other liquids, or signs of fire or smoke damage.
7. Check for worn, frayed, or pinched cables.

8. Check that the power-supply cover fasteners (screws or rivets) have not been removed or tampered with.

Handling electrostatic discharge-sensitive devices

Any computer part containing transistors or integrated circuits (ICs) should be considered sensitive to electrostatic discharge (ESD). ESD damage can occur when there is a difference in charge between objects. Protect against ESD damage by equalizing the charge so that the server, the part, the work mat, and the person handling the part are all at the same charge.

Notes:

1. Use product-specific ESD procedures when they exceed the requirements noted here.
2. Make sure that the ESD-protective devices you use have been certified (ISO 9000) as fully effective.

When handling ESD-sensitive parts:

- Keep the parts in protective packages until they are inserted into the product.
- Avoid contact with other people.
- Wear a grounded wrist strap against your skin to eliminate static on your body.
- Prevent the part from touching your clothing. Most clothing is insulative and retains a charge even when you are wearing a wrist strap.
- Use the black side of a grounded work mat to provide a static-free work surface. The mat is especially useful when handling ESD-sensitive devices.
- Select a grounding system, such as those in the following list, to provide protection that meets the specific service requirement.

Note: The use of a grounding system is desirable but not required to protect against ESD damage.

- Attach the ESD ground clip to any frame ground, ground braid, or green-wire ground.
- Use an ESD common ground or reference point when working on a double-insulated or battery-operated system. You can use coax or connector-outside shells on these systems.
- Use the round ground-prong of the ac plug on ac-operated computers.

Grounding requirements

Electrical grounding of the computer is required for operator safety and correct system function. Proper grounding of the electrical outlet can be verified by a certified electrician.

Safety notices (multilingual translations)

The caution and danger safety notices in this section are provided in the following languages:

- English
- Brazilian/Portuguese
- Chinese
- French
- German
- Italian
- Japanese
- Korean
- Spanish

Important: All caution and danger statements in this IBM documentation begin with a number. This number is used to cross reference an English caution or danger statement with translated versions of the caution or danger statement in this section.

For example, if a caution statement begins with a number 1, translations for that caution statement appear in this section under statement 1.

Be sure to read all caution and danger statements before performing any of the instructions.

Statement 1:



DANGER

Electrical current from power, telephone, and communication cables is hazardous.

To avoid a shock hazard:

- **Do not connect or disconnect any cables or perform installation, maintenance, or reconfiguration of this product during an electrical storm.**
- **Connect all power cords to a properly wired and grounded electrical outlet.**
- **Connect to properly wired outlets any equipment that will be attached to this product.**
- **When possible, use one hand only to connect or disconnect signal cables.**
- **Never turn on any equipment when there is evidence of fire, water, or structural damage.**
- **Disconnect the attached power cords, telecommunications systems, networks, and modems before you open the device covers, unless instructed otherwise in the installation and configuration procedures.**
- **Connect and disconnect cables as described in the following table when installing, moving, or opening covers on this product or attached devices.**

To Connect:

1. Turn everything OFF.
2. First, attach all cables to devices.
3. Attach signal cables to connectors.
4. Attach power cords to outlet.
5. Turn device ON.

To Disconnect:

1. Turn everything OFF.
2. First, remove power cords from outlet.
3. Remove signal cables from connectors.
4. Remove all cables from devices.

Statement 2:



CAUTION:

When replacing the lithium battery, use only IBM Part Number 33F8354 or an equivalent type battery recommended by the manufacturer. If your system has a module containing a lithium battery, replace it only with the same module type made by the same manufacturer. The battery contains lithium and can explode if not properly used, handled, or disposed of.

Do not:

- Throw or immerse into water
- Heat to more than 100°C (212°F)
- Repair or disassemble

Dispose of the battery as required by local ordinances or regulations.

Statement 3:



CAUTION:

When laser products (such as CD-ROMs, DVD drives, fiber optic devices, or transmitters) are installed, note the following:

- Do not remove the covers. Removing the covers of the laser product could result in exposure to hazardous laser radiation. There are no serviceable parts inside the device.
- Use of controls or adjustments or performance of procedures other than those specified herein might result in hazardous radiation exposure.



DANGER

Some laser products contain an embedded Class 3A or Class 3B laser diode. Note the following.

Laser radiation when open. Do not stare into the beam, do not view directly with optical instruments, and avoid direct exposure to the beam.

Statement 4:



≥ 18 kg (39.7 lb)



≥ 32 kg (70.5 lb)

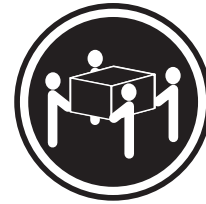

≥ 55 kg (121.2 lb)

CAUTION:
Use safe practices when lifting.

Statement 5:



CAUTION:
The power control button on the device and the power switch on the power supply do not turn off the electrical current supplied to the device. The device also might have more than one power cord. To remove all electrical current from the device, ensure that all power cords are disconnected from the power source.

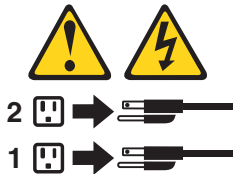

Statement 8:



CAUTION:

Never remove the cover on a power supply or any part that has the following label attached.



Hazardous voltage, current, and energy levels are present inside any component that has this label attached. There are no serviceable parts inside these components. If you suspect a problem with one of these parts, contact a service technician.

Statement 10:



CAUTION:

Do not place any object weighing more than 82 kg (180 lb) on top of rack-mounted devices.



>82 kg (180 lb)

Importante:

Todas as instruções de cuidado e perigo da IBM documentation começam com um número. Este número é utilizado para fazer referência cruzada de uma instrução de cuidado ou perigo no idioma inglês com as versões traduzidas das instruções de cuidado ou perigo encontradas nesta seção.

Por exemplo, se uma instrução de cuidado é iniciada com o número 1, as traduções para aquela instrução de cuidado aparecem nesta seção sob a instrução 1.

Certifique-se de ler todas as instruções de cuidado e perigo antes de executar qualquer operação.

Instrução 1



PERIGO

A corrente elétrica proveniente de cabos de alimentação, de telefone e de comunicações é perigosa.

Para evitar risco de choque:

- Não conecte ou desconecte cabos e não realize instalação, manutenção ou reconfiguração deste produto durante uma tempestade com raios.
- Conecte todos os cabos de alimentação a tomadas elétricas corretamente instaladas e aterradas.
- Conecte todos os equipamentos ao qual esse produto será conectado a tomadas corretamente instaladas.
- Sempre que possível, utilize apenas uma das mãos para conectar ou desconectar cabos de sinal.
- Nunca ligue qualquer equipamento quando existir evidência de danos por fogo, água ou na estrutura.
- Desconecte cabos de alimentação, sistemas de telecomunicação, redes e modems antes de abrir as tampas dos dispositivos, a menos que especificado de maneira diferente nos procedimentos de instalação e configuração.
- Conecte e desconecte cabos conforme descrito na seguinte tabela, ao instalar ou movimentar este produto ou os dispositivos conectados, ou ao abrir suas tampas.

Para Conectar:	Para Desconectar:
<ol style="list-style-type: none">1. DESLIGUE Tudo.2. Primeiramente, conecte todos os cabos aos dispositivos.3. Conecte os cabos de sinal aos conectores.4. Conecte os cabos de alimentação às tomadas.5. LIGUE os dispositivos.	<ol style="list-style-type: none">1. DESLIGUE Tudo.2. Primeiramente, remova os cabos de alimentação das tomadas.3. Remova os cabos de sinal dos conectores.4. Remova todos os cabos dos dispositivos.

Instrução 2



CUIDADO:

Ao substituir a bateria de lítio, utilize apenas uma bateria IBM, Número de Peça 33F8354 ou uma bateria de tipo equivalente, recomendada pelo fabricante. Se o seu sistema possui um módulo com uma bateria de lítio, substitua-o apenas pelo mesmo tipo de módulo, do mesmo fabricante. A bateria contém lítio e pode explodir se não for utilizada, manuseada e descartada de maneira correta.

Não:

- Jogue ou coloque na água
- Aqueça a mais de 100°C (212°F)
- Conserte nem desmonte

Para descartar a bateria, entre em contato com a área de atendimento a clientes IBM, pelo telefone (011) 889-8986, para obter informações sobre como enviar a bateria pelo correio para a IBM.

Instrução 3



PRECAUCIÓN:

Quando produtos a laser (unidades de CD-ROM, unidades de DVD, dispositivos de fibra ótica, transmissores, etc.) estiverem instalados, observe o seguinte:

- Não remova as tampas. A remoção das tampas de um produto a laser pode resultar em exposição prejudicial à radiação de laser. Nenhuma peça localizada no interior do dispositivo pode ser consertada.
- A utilização de controles ou ajustes ou a execução de procedimentos diferentes dos especificados aqui pode resultar em exposição prejudicial à radiação.



PERIGO

Alguns produtos a laser contêm um diodo laser da Classe 3A ou Classe 3B embutido. Observe o seguinte:

Radiação de laser quando aberto. Não olhe diretamente para o raio a olho nu ou com instrumentos óticos, e evite exposição direta ao raio.

Instrução 4

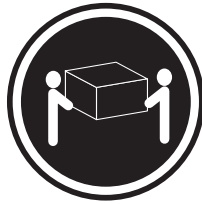

≥18 kg (37 lbs)



≥32 kg (70.5 lbs)

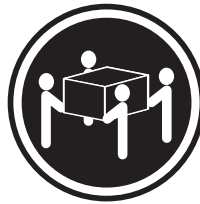

≥55 kg (121.2 lbs)

CUIDADO:

Ao levantar a máquina, faça-o com segurança.

Instrução 5



CUIDADO:

Os botões Liga/Desliga localizados no dispositivo e na fonte de alimentação não desligam a corrente elétrica fornecida ao dispositivo. O dispositivo também pode ter mais de um cabo de alimentação. Para remover toda a corrente elétrica do dispositivo, assegure que todos os cabos de alimentação estejam desconectados da fonte de energia elétrica.

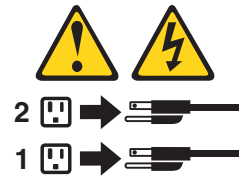

Instrução 8



CUIDADO:

Nunca remova a tampa de uma fonte de alimentação ou de qualquer peça que tenha esta etiqueta afixada.



Níveis perigosos de voltagem, corrente e energia estão presentes em qualquer componente que tenha esta etiqueta afixada. Nenhuma peça localizada no interior desses componentes pode ser consertada. Se você suspeitar de algum problema em alguma dessas peças, entre em contato com um técnico IBM.

Instrução 10

CUIDADO:

Não coloque nenhum objeto com peso superior a 82 kg (180 lbs.) sobre dispositivos montados em rack.



重要:

Server Library 中的所有提醒和危险条款前都有一个数字标识。该数字是用来交叉引用一个英文的提醒和危险条款及本部分中的与之对应的已翻译成其它文字的提醒和危险条款。

例如，如果一个提醒条款前的数字为 1，则本部分中相应的译文也带有标号 1。

在执行任何指示的操作之前，请确保您已经阅读了全部提醒和危险条款。

声明 1



危险

电源、电话和通信电缆中带有危险电流。

为避免电击：

雷电期间不要拆接电缆或安装、维修及重新配置本产品。

将所有电源线连接至正确布线并已安全接地的电源插座上。

将与本产品连接的所有设备连接至正确布线的插座上。

尽量只使用单手拆接信号电缆。

有水、火及结构损坏迹象时，请勿打开任何设备。

除非在安装配置过程中有明确指示，否则，打开设备机盖前应先断开与电源线、远程通信系统、网络和调制解调器的所有连接。

安装、移动或打开本产品及其附带设备的机盖时，应按下表所述连接和断开电缆。

连接时：

1. 关闭所有设备。
2. 首先将所有电缆连接至设备。
3. 将信号电缆连接至接口。
4. 将电源线连接至插座。

断开连接时：

1. 关闭所有设备。
2. 首先从插座中拔出电源线。
3. 从接口上拔下信号电缆。

声明 2



警告:

更换锂电池时，只能使用 IBM 产品号 33F8354 或者是厂商推荐的等同类型的电池。

如果系统模块中含有锂电池，则只能使用同一厂商制造的同一类型的模块进行更换。电池中含有锂，如果使用、拿放或处理不当，可能会发生爆炸。

请勿对电池进行下列操作：
扔入或浸入水中
加热超过 100 (212 F)
进行修理或分解
请按本地法规要求处理电池。

声明 3



警告:

安装激光产品（如 CD-ROM、DVD 驱动器、光纤设备或送话器）时，应注意以下事项：

不要拆除外盖。拆除激光产品的外盖可能会导致激光辐射的危险，本设备中没有用户可维修的部件。

非此处指定的其它控制、调整或与性能有关的操作都有可能导致激光辐射的危险。



危险

某些激光产品中包含内嵌的 3A 级或 3B 级激光二极管。请注意以下事项。
打开时会产生激光辐射。不要直视光束，不要使用光学仪器直接观看光束，避免直接暴露于光束之下。

声明 4



≥18 kg (37 磅)



≥32 kg (70.5 磅)



≥55 kg (121.2 磅)

警告：
抬起时请采用安全操作方法。

声明 5



警告：
使用设备上的电源控制按钮和电源上的开关都不能断开本设备上的电流。另外，本设备可能带有多条电源线。如要断开设备上的所有电流，请确保所有电源线均已与电源断开连接。



声明 6



警告：
如果在电源线连接设备的一端安装了固定松紧夹，则必须将电源线的另一端连接至使用方便的电源。

声明 4



≥18 kg (37 磅)



≥32 kg (70.5 磅)



≥55 kg (121.2 磅)

警告：
抬起时请采用安全操作方法。

声明 5



警告：
使用设备上的电源控制按钮和电源上的开关都不能断开本设备上的电流。另外，本设备可能带有多条电源线。如要断开设备上的所有电流，请确保所有电源线均已与电源断开连接。



声明 6



警告：
如果在电源线连接设备的一端安装了固定松紧夹，则必须将电源线的另一端连接至使用方便的电源。

声明 11



警告：
下面的标签表明附近有锋利的边、角或接头。



声明 12



警告：
下面的标签表明附近有高热表面。



重要資訊：

Server Library 中所有「注意」及「危險」的聲明均以數字開始。此一數字是用來作為交互參考之用，英文「注意」或「危險」聲明可在本節中找到相同內容的「注意」或「危險」聲明的譯文。

例如，有一「危險」聲明以數字 1 開始，則該「危險」聲明的譯文將出現在本節的「聲明」1 中。

執行任何指示之前，請詳讀所有「注意」及「危險」的聲明。

聲明 1



危險

電源、電話及通信電纜上所產生的電流均有危險性。

欲避免電擊危險：

- 在雷雨期間，請勿連接或切斷本產品上的任何電纜線，或安裝、維修及重新架構本產品。
- 請將電源線接至接線及接地正確的電源插座。
- 請將本產品隨附的設備連接至接線正確的插座。
- 儘可能使用單手來連接或切斷信號電纜線。
- 當設備有火燒或泡水的痕跡，或有結構性損害時，請勿開啓該設備的電源。
- 在安裝及架構之時，若非非常熟悉，在開啓裝置蓋子之前，請切斷電源線、電信系統、網路及數據機。
- 在安裝、移動本產品或附加裝置，或開啓其蓋子時，請依照下表中「連接」及「切斷」電纜線的步驟執行。

連接：

1. 關閉所有開關。
2. 先將所有電纜線接上裝置。
3. 將信號電纜接上接頭。
4. 再將電源線接上電源插座。
5. 開啓裝置的電源。

切斷：

1. 關閉所有開關。
2. 先自電源插座拔掉電源線。
3. 拔掉接頭上的所有信號電纜。
4. 再拔掉裝置上的所有電纜線。

聲明 2



注意：

更換鋰電池時，只可使用 IBM 零件編號 33F8354 的電池，或製造商建議之相當類型的電池。若系統中具有包含鋰電池的模組，在更換此模組時，請使用相同廠商製造的相同模組類型。如未正確使用、處理或丟棄含有鋰的電池時，可能會引發爆炸。

請勿將電池：

- 丟入或浸入水中
- 加熱超過 100 °C (212 °F)
- 修理或拆開

請遵照當地法令規章處理廢棄電池。

聲明 3



注意：

安裝雷射產品(如 CD-ROM、DVD 光碟機、光纖裝置或發射器)時，請注意下列事項：

- 請勿移開蓋子。移開雷射產品的蓋子，您可能會暴露於危險的雷射輻射之下。裝置中沒有需要維修的組件。
- 不依此處所指示的控制、調整或處理步驟，您可能會暴露於危險的輻射之下。



危險

有些雷射產品含有內嵌式 Class 3A 或 Class 3B 雷射二極體。請注意下列事項：

開啓時會產生雷射輻射。請勿凝視光束，不要使用光學儀器直接觀察，且應避免直接暴露在光束下。

聲明 4



≥ 18 公斤 (37 磅) ≥ 32 公斤 (70.5 磅) ≥ 55 公斤 (121.2 磅)

注意：

抬起裝置時，請注意安全措施。

聲明 5



注意：

裝置上的電源控制按鈕及電源供應器上的電源開關均無法關閉裝置上的電流。

本裝置可能有一條以上的電源線。如要移除裝置上的所有電流，請確認所有電源線已與電源分離。



聲明 10



注意：

請勿將任何重量超過 82 公斤 (180 磅) 的物品置於已安裝機架的裝置上方。



>82 公斤 (180 磅)

Important:

Toutes les consignes Attention et Danger indiquées dans la bibliothèque IBM documentation sont précédées d'un numéro. Ce dernier permet de mettre en correspondance la consigne en anglais avec ses versions traduites dans la présente section.

Par exemple, si une consigne de type Attention est précédée du chiffre 1, ses traductions sont également précédées du chiffre 1 dans la présente section.

Prenez connaissance de toutes les consignes de type Attention et Danger avant de procéder aux opérations décrites par les instructions.

Notice n° 1



DANGER

Le courant électrique passant dans les câbles de communication, ou les cordons téléphoniques et d'alimentation peut être dangereux.

Pour éviter tout risque de choc électrique:

- Ne manipulez aucun câble et n'effectuez aucune opération d'installation, d'entretien ou de reconfiguration de ce produit au cours d'un orage.
- Branchez tous les cordons d'alimentation sur un socle de prise de courant correctement câblé et mis à la terre.
- Branchez sur des socles de prise de courant correctement câblés tout équipement connecté à ce produit.
- Lorsque cela est possible, n'utilisez qu'une seule main pour connecter ou déconnecter les câbles d'interface.
- Ne mettez jamais un équipement sous tension en cas d'incendie ou d'inondation, ou en présence de dommages matériels.
- Avant de retirer les carters de l'unité, mettez celle-ci hors tension et déconnectez ses cordons d'alimentation, ainsi que les câbles qui la relient aux réseaux, aux systèmes de télécommunication et aux modems (sauf instruction contraire mentionnée dans les procédures d'installation et de configuration).
- Lorsque vous installez ou que vous déplacez le présent produit ou des périphériques qui lui sont raccordés, reportez-vous aux instructions ci-dessous pour connecter et déconnecter les différents cordons.

Connexion	Déconnexion
<ol style="list-style-type: none"> 1. Mettez les unités hors tension. 2. Commencez par brancher tous les cordons sur les unités. 3. Branchez les câbles d'interface sur des connecteurs. 4. Branchez les cordons d'alimentation sur des prises. 5. Mettez les unités sous tension. 	<ol style="list-style-type: none"> 1. Mettez les unités hors tension. 2. Débranchez les cordons d'alimentation des prises. 3. Débranchez les câbles d'interface des connecteurs. 4. Débranchez tous les câbles des unités.

Notice n° 2



ATTENTION:

Remplacez la pile au lithium usagée par une pile de référence identique exclusivement - voir la référence IBM - ou par une pile équivalente recommandée par le fabricant. Si votre système est doté d'un module contenant une pile au lithium, vous devez le remplacer uniquement par un module identique, produit par le même fabricant. La pile contient du lithium et présente donc un risque d'explosion en cas de mauvaise manipulation ou utilisation.

- Ne la jetez pas à l'eau.
- Ne l'exposez pas à une température supérieure à 100 °C.
- Ne cherchez pas à la réparer ou à la démonter.

Pour la mise au rebut, reportez-vous à la réglementation en vigueur.

Notice n° 3



ATTENTION:

Si des produits laser sont installés (tels que des unités de CD-ROM ou de DVD, des périphériques contenant des fibres optiques ou des émetteurs-récepteurs), prenez connaissance des informations suivantes:

- N'ouvrez pas ces produits pour éviter une exposition directe au rayon laser. Vous ne pouvez effectuer aucune opération de maintenance à l'intérieur.
- Pour éviter tout risque d'exposition au rayon laser, respectez les consignes de réglage et d'utilisation des commandes, ainsi que les procédures décrites dans le présent document.



DANGER

Certains produits laser contiennent une diode laser de classe 3A ou 3B. Prenez connaissance des informations suivantes:

Rayonnement laser lorsque le carter est ouvert. évitez de regarder fixement le faisceau ou de l'observer à l'aide d'instruments optiques. évitez une exposition directe au rayon.

Notice n° 4

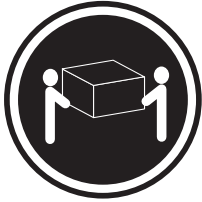

≥18 kg (37 lbs)



≥32 kg (70.5 lbs)

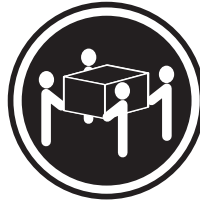

≥55 kg (121.2 lbs)

ATTENTION:

Faites-vous aider pour soulever ce produit.

Notice n° 5



ATTENTION:

Le bouton de mise sous tension/hors tension de l'unité et l'interrupteur d'alimentation du bloc d'alimentation ne coupent pas l'arrivée de courant électrique à l'intérieur de la machine. Il se peut que votre unité dispose de plusieurs cordons d'alimentation. Pour isoler totalement l'unité du réseau électrique, débranchez tous les cordons d'alimentation des socles de prise de courant.



Notice n° 8



ATTENTION:

N'ouvrez jamais le bloc d'alimentation ou tout élément sur lequel est apposée l'étiquette ci-dessous.



Des tensions et des courants dangereux sont présents à l'intérieur de tout composant sur lequel est apposée cette étiquette. Ces éléments ne peuvent pas être réparés. Si vous pensez qu'ils peuvent être à l'origine d'un incident, prenez contact avec un technicien de maintenance.

Notice n° 10

ATTENTION:

Ne posez pas d'objet dont le poids dépasse 82 kg sur les unités montées en armoire.



Wichtig:

Alle Sicherheitshinweise in dieser IBM documentation beginnen mit einer Nummer. Diese Nummer verweist auf einen englischen Sicherheitshinweis mit den übersetzten Versionen dieses Hinweises in diesem Abschnitt.

Wenn z. B. ein Sicherheitshinweis mit der Nummer 1 beginnt, so erscheint die Übersetzung für diesen Sicherheitshinweis in diesem Abschnitt unter dem Hinweis 1.

Lesen Sie alle Sicherheitshinweise, bevor Sie eine Anweisung ausführen.

Hinweis 1



VORSICHT

Elektrische Spannungen von Netz-, Telefon- und Datenübertragungsleitungen sind gefährlich.

Aus Sicherheitsgründen:

- Bei Gewitter an diesem Gerät keine Kabel anschließen oder lösen. Ferner keine Installations-, Wartungs- oder Rekonfigurationsarbeiten durchführen.
- Gerät nur an eine Schutzkontaktsteckdose mit ordnungsgemäß geerdetem Schutzkontakt anschließen.
- Alle angeschlossenen Geräte ebenfalls an Schutzkontaktsteckdosen mit ordnungsgemäß geerdetem Schutzkontakt anschließen.
- Signalkabel möglichst einhändig anschließen oder lösen.
- Keine Geräte einschalten, wenn die Gefahr einer Beschädigung durch Feuer, Wasser oder andere Einflüsse besteht.
- Die Verbindung zu den angeschlossenen Netzkabeln, Telekommunikationssystemen, Netzwerken und Modems ist vor dem Öffnen des Gehäuses zu unterbrechen. Es sei denn, dies ist in den zugehörigen Installations- und Konfigurationsprozeduren anders angegeben.
- Nur nach den nachfolgend aufgeführten Anweisungen arbeiten, die für Installation, Transport oder Öffnen von Gehäusen von Personal Computern oder angeschlossenen Einheiten gelten.

Kabel anschließen:	Kabel lösen:
<ol style="list-style-type: none"> 1. Alle Geräte ausschalten und Netzstecker ziehen. 2. Zuerst alle Kabel an Einheiten anschließen. 3. Signalkabel an Anschlußbuchsen anschließen. 4. Netzstecker an Steckdose anschließen. 5. Gerät einschalten. 	<ol style="list-style-type: none"> 1. Alle Geräte ausschalten. 2. Zuerst Netzstecker von Steckdose lösen. 3. Signalkabel von Anschlußbuchsen lösen. 4. Alle Kabel von Einheiten lösen.

Hinweis 2



ACHTUNG:

Eine verbrauchte Batterie nur durch eine Batterie mit der IBM Teilenummer 33F8354 oder durch eine vom Hersteller empfohlene Batterie ersetzen. Wenn Ihr System ein Modul mit einer Lithium-Batterie enthält, ersetzen Sie es immer mit dem selben Modultyp vom selben Hersteller. Die Batterie enthält Lithium und kann bei unsachgemäßer Verwendung, Handhabung oder Entsorgung explodieren.

Die Batterie nicht:

- mit Wasser in Berührung bringen.
- über 100 C erhitzen.
- reparieren oder zerlegen.

Die örtlichen Bestimmungen für die Entsorgung von Sondermüll beachten.

Hinweis 3



ACHTUNG:

Wenn ein Laserprodukt (z. B. CD-ROM-Laufwerke, DVD-Laufwerke, Einheiten mit Glasfaserkabeln oder Transmitter) installiert ist, beachten Sie folgendes.

- Das Entfernen der Abdeckungen des CD-ROM-Laufwerks kann zu gefährlicher Laserstrahlung führen. Es befinden sich keine Teile innerhalb des CD-ROM-Laufwerks, die vom Benutzer gewartet werden müssen. Die Verkleidung des CD-ROM-Laufwerks nicht öffnen.
- Steuer- und Einstellelemente sowie Verfahren nur entsprechend den Anweisungen im vorliegenden Handbuch einsetzen. Andernfalls kann gefährliche Laserstrahlung auftreten.



VORSICHT

Manche CD-ROM-Laufwerke enthalten eine eingebaute Laserdiode der Klasse 3A oder 3B. Die nachfolgend aufgeführten Punkte beachten.

Laserstrahlung bei geöffneter Tür. Niemals direkt in den Laserstrahl sehen, nicht direkt mit optischen Instrumenten betrachten und den Strahlungsbereich meiden.

Hinweis 4

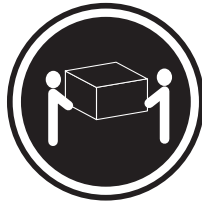

≥18 kg



≥32 kg

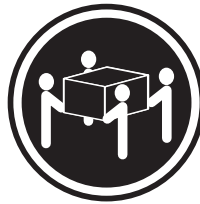

≥55 kg

ACHTUNG:

Beim Anheben der Maschine die vorgeschriebenen Sicherheitsbestimmungen beachten.

Hinweis 5



ACHTUNG:

Mit dem Betriebsspannungsschalter an der Vorderseite des Servers und dem Betriebsspannungsschalter am Netzteil wird die Stromversorgung für den Server nicht unterbrochen. Der Server könnte auch mehr als ein Netzkabel aufweisen. Um die gesamte Stromversorgung des Servers auszuschalten, muß sichergestellt werden, daß alle Netzkabel aus den Netzsteckdosen herausgezogen wurden.

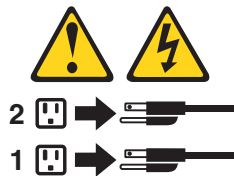

Hinweis 8



ACHTUNG:

Die Abdeckung oder eine Komponente eines Netzteils, die wie nachfolgend aufgeführt gekennzeichnet ist, darf keinesfalls entfernt werden.



In Komponenten, die so gekennzeichnet sind, können gefährliche Spannungen anliegen. In diesen Komponenten sind keine Teile vorhanden, die vom Benutzer gewartet werden müssen. Besteht der Verdacht, dass an einem dieser Teile ein Fehler aufgetreten ist, ist ein IBM Kundendiensttechniker zu verständigen.

Hinweis 10
ACHTUNG:

Keine Gegenstände, die mehr als 82 kg wiegen, auf Rack-Einheiten ablegen.



Importante:

Tutti gli avvisi di attenzione e di pericolo riportati nella pubblicazione IBM documentation iniziano con un numero. Questo numero viene utilizzato per confrontare avvisi di attenzione o di pericolo in inglese con le versioni tradotte riportate in questa sezione.

Ad esempio, se un avviso di attenzione inizia con il numero 1, la relativa versione tradotta è presente in questa sezione con la stessa numerazione.

Prima di eseguire una qualsiasi istruzione, accertarsi di leggere tutti gli avvisi di attenzione e di pericolo.

Avviso 1



PERICOLO

La corrente elettrica circolante nei cavi di alimentazione, del telefono e di segnale è pericolosa.

Per evitare il pericolo di scosse elettriche:

- Non collegare o scollegare i cavi, non effettuare l'installazione, la manutenzione o la riconfigurazione di questo prodotto durante i temporali.
- Collegare tutti i cavi di alimentazione ad una presa elettrica correttamente cablata e munita di terra di sicurezza.
- Collegare qualsiasi apparecchiatura collegata a questo prodotto ad una presa elettrica correttamente cablata e munita di terra di sicurezza.
- Quando possibile, collegare o scollegare i cavi di segnale con una sola mano.
- Non accendere qualsiasi apparecchiatura in presenza di fuoco, acqua o se sono presenti danni all'apparecchiatura stessa.
- Scollegare i cavi di alimentazione, i sistemi di telecomunicazioni, le reti e i modem prima di aprire i coperchi delle unità, se non diversamente indicato nelle procedure di installazione e configurazione.
- Collegare e scollegare i cavi come descritto nella seguente tabella quando si effettuano l'installazione, la rimozione o l'apertura dei coperchi di questo prodotto o delle unità collegate.

Per collegare:	Per scollegare:
<ol style="list-style-type: none">1. SPEGNERE tutti i dispositivi.2. Collegare prima tutti i cavi alle unità.3. Collegare i cavi di segnale ai connettori.4. Collegare i cavi di alimentazione alle prese elettriche.5. ACCENDERE le unità.	<ol style="list-style-type: none">1. SPEGNERE tutti i dispositivi.2. Rimuovere prima i cavi di alimentazione dalle prese elettriche.3. Rimuovere i cavi di segnale dai connettori.4. Rimuovere tutti i cavi dalle unità.

Avviso 2



ATTENZIONE:

Quando si sostituisce la batteria al litio, utilizzare solo una batteria IBM con numero parte 33F8354 o batterie dello stesso tipo o di tipo equivalente consigliate dal produttore. Se il sistema di cui si dispone è provvisto di un modulo contenente una batteria al litio, sostituire tale batteria solo con un tipo di modulo uguale a quello fornito dal produttore. La batteria contiene litio e può esplodere se utilizzata, maneggiata o smaltita impropriamente.

Evitare di:

- Gettarla o immergerla in acqua
- Riscaldarla ad una temperatura superiore ai 100°C
- Cercare di ripararla o smontarla

Smaltire secondo la normativa in vigore (D.Lgs 22 del 5/2/9) e successive disposizioni nazionali e locali.

Avviso 3



ATTENZIONE:

Quando si installano prodotti laser come, ad esempio, le unità DVD, CD-ROM, a fibre ottiche o trasmettitori, prestare attenzione a quanto segue:

- Non rimuovere i coperchi. L'apertura dei coperchi di prodotti laser può determinare l'esposizione a radiazioni laser pericolose. All'interno delle unità non vi sono parti su cui effettuare l'assistenza tecnica.
- L'utilizzo di controlli, regolazioni o l'esecuzione di procedure non descritti nel presente manuale possono provocare l'esposizione a radiazioni pericolose.



PERICOLO

Alcuni prodotti laser contengono all'interno un diodo laser di Classe 3A o Classe 3B. Prestare attenzione a quanto segue:

Aperto l'unità vengono emesse radiazioni laser. Non fissare il fascio, non guardarlo direttamente con strumenti ottici ed evitare l'esposizione diretta al fascio.

Avviso 4

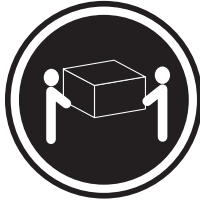

≥18 kg



≥32 kg

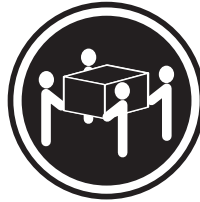

≥55 kg

ATTENZIONE:

Durante il sollevamento della macchina seguire delle norme di sicurezza.

Avviso 5



ATTENZIONE:

Il pulsante del controllo dell'alimentazione situato sull'unità e l'interruttore di alimentazione posto sull'alimentatore non disattiva la corrente elettrica fornita all'unità. L'unità potrebbe disporre di più di un cavo di alimentazione. Per disattivare la corrente elettrica dall'unità, accertarsi che tutti i cavi di alimentazione siano scollegati dalla sorgente di alimentazione.

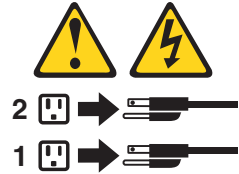

Avviso 8



ATTENZIONE:

Non togliere mai il coperchio di un alimentatore o qualsiasi parte su cui è posta la seguente etichetta.



Tensioni pericolose, corrente e livelli di energia sono presenti all'interno del componente su cui è posta questa etichetta. All'interno di questi componenti non vi sono parti su cui effettuare l'assistenza tecnica. Se si sospetta un problema in una di queste parti, rivolgersi ad un tecnico di manutenzione.

Avviso 10 ATTENZIONE:

Non poggiare oggetti che pesano più di 82 kg sulla parte superiore delle unità montate in rack.



重要:

Netfinity Server ライブラリーにあるすべての注意および危険の記述は数字で始まります。この数字は、英語版の注意および危険の記述と翻訳された注意および危険の記述を相互参照するために使用します。

例えば、もし注意の記述が数字の1で始まっている場合は、その注意の翻訳は、記述 1 の下にあります。

手順を実施する前に、すべての注意:

・記述 1

⚠ 危険

感電を防止するため、雷の発生時には、いかなるケーブルの取り付けまたは取り外しも行わないでください。また導入、保守、再構成などの作業も行わないでください。

感電を防止するため:

- 電源コードは正しく接地および配線が行われている電源に接続してください。
- 本製品が接続されるすべての装置もまた正しく配線された電源に接続されている必要があります。

できれば、信号ケーブルに取り付けまたは取り外しのときは片方の手のみで行うようにしてください。これにより、電位差がある二つの表面に触ることによる感電を防ぐことができます。

電源コード、電話ケーブル、通信ケーブルからの電流は身体に危険を及ぼします。設置、移動、または製品のカバーを開けたり装置を接続したりするときには、以下のようにケーブルの接続、取り外しを行ってください。

接続するには

1. すべての電源を切る
2. まず、装置にすべてのケーブルを接続する。
3. 次に、通信ケーブルをコネクタに接続する
4. その後、電源コンセントに電源コードを接続する
5. 装置の電源を入れる。

取り外すには

1. すべての電源を切る
2. まず、電源コンセントから電源コードを取り外す
3. 次に、通信ケーブルをコネクタから取り外す。
4. その後、装置からすべてのケーブルを取り外す

注意

本製品には、システム・ボード上にリチウム電池が使用されています。電池の交換方法や取り扱いを誤ると、発熱、発火、破裂のおそれがあります。

電池の交換には、IBM部品番号33F8354の電池またはメーカー推奨の同等の電池を使用してください。

交換用電池の購入については、お買い求めの販売店または弊社の営業担当までお問い合わせください。

電池は幼児の手の届かない所に置いてください。

万一、幼児が電池を飲み込んだときは、直ちに医師に相談してください。

以下の行為は絶対にしないでください。

- －水にぬらすこと
- －100度C 以上の過熱や焼却
- －分解や充電
- －ショート

電池を廃棄する場合、および保存する場合にはテープなどで絶縁してください。他の金属や電池と混ざると発火、破裂の原因となります。電池は地方自治体の条例、または規則に従って廃棄してください。ごみ廃棄場で処分されるごみの中に捨てないでください。

注意

レーザー製品 (CD-ROM、DVD、または光ファイバー装置または送信器など) が組み込まれている場合は、下記に御注意ください。

- －ここに記載されている制御方法、調整方法、または性能を超えて使用すると、危険な放射線を浴びる可能性があります。
- －ドライブのカバーを開けると、危険な放射線を浴びる可能性があります。ドライブの内部に修理のために交換可能な部品はありません。カバーを開けないでください。

危険

一部 CD-ROM ドライブは、Class 3A または Class 3B レーザー・ダイオードを使用しています。次の点に注意してください。

CD-ROMドライブのカバーを開けるとレーザーが放射されます。光線を見つめたり、光学器械を使って直接見たりしないでください。また直接光線を浴びないようにしてください。

・記述 4

⚠ 注意



18Kg 以上



32Kg 以上



55Kg 以上

装置を持ち上げる場合は、安全に持ち上げる方法に従ってください。

・記述 5

⚠ 注意 ⚡

サーバーの前面にある電源制御ボタンは、サーバーに供給された電流を遮断しません。

サーバーには、複数の電源コードが接続されているかもしれません。

サーバーから電流を完全に遮断するために、すべての電源コードが電源から取り外されていることを確認してください。

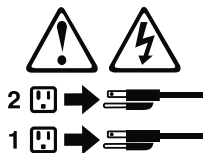

・記述 10

⚠ 注意

ラック・モデルのサーバーの上に 82 Kg 以上の物を置かないでください。



중요:

본 *Server Library*에 있는 모든 주의 및 위험 경고문은 번호로 시작합니다. 이 번호는 영문 주의 혹은 위험 경고문과 이 절에 나오는 번역된 버전의 주의 혹은 위험 경고문을 상호 참조하는 데 사용됩니다.

예를 들어, 주의 경고문이 번호 1로 시작하면, 번역된 해당 주의 경고문을 본 절의 경고문 1에서 찾아볼 수 있습니다.

모든 지시사항을 수행하기 전에 반드시 모든 주의 및 위험 경고문을 읽으십시오.

경고문 1



위험

전원, 전화 및 통신 케이블로부터 흘러 나오는 전류는 위험합니다.

전기 충격을 피하려면:

- 뇌우를 동반할 때는 케이블의 연결이나 철수, 이 제품의 설치, 유지보수 또는 재구성을 하지 마십시오.
- 모든 전원 코드를 적절히 배선 및 접지해야 합니다.
- 이 제품에 연결될 모든 장비를 적절하게 배선된 콘센트에 연결하십시오.
- 가능한 한 신호 케이블을 한 손으로 연결하거나 끊으십시오.
- 화재, 수해 또는 구조상의 손상이 있을 경우 장비를 켜지 마십시오.
- 설치 및 구성 프로시저에 다른 설명이 없는 한, 장치 덮개를 열기 전에 연결된 전원 코드, 원거리 통신 시스템, 네트워크 및 모뎀을 끊어 주십시오.
- 제품 또는 접속된 장치를 설치, 이동 및 덮개를 열 때 다음 설명에 따라 케이블을 연결하거나 끊도록 하십시오.

연결하려면:

1. 모든 스위치를 끕니다.
2. 먼저 모든 케이블을 장치에 연결합니다.
3. 신호 케이블을 커넥터에 연결합니다.
4. 콘센트에 전원 코드를 연결합니다.
5. 장치 스위치를 켭니다.

연결을 끊으려면:

1. 모든 스위치를 끕니다.
2. 먼저 콘센트에서 전원 코드를 뽑습니다.
3. 신호 케이블을 커넥터에서 제거합니다.
4. 장치에서 모든 케이블을 제거합니다.

경고문 2



주의:

리튬 배터리를 교체할 때는 IBM 부품 번호 33F8354 또는 제조업체에서 권장하는 동등한 유형의 배터리를 사용하십시오. 시스템에 리튬 배터리를 갖고 있는 모듈이 있으면 동일한 제조업체에서 생산된 동일한 모듈 유형으로 교체하십시오. 배터리에 리튬이 있을 경우 제대로 사용, 처리 또는 처분하지 않으면 폭발할 수 있습니다.

다음은 주의하십시오.

- 던지거나 물에 담그지 않도록 하십시오.
- 100°C(212°F) 이상으로 가열하지 마십시오.
- 수리하거나 분해하지 마십시오.

지역 법령이나 규정의 요구에 따라 배터리를 처분하십시오.

경고문 3



주의:

레이저 제품(CD-ROMs, DVD 드라이브, 광 장치 또는 트랜스미터 등과 같은)이 설치되어 있을 경우 다음을 유의하십시오.

- 덮개를 제거하지 마십시오. 레이저 제품의 덮개를 제거했을 경우 위험한 레이저 광선에 노출될 수 있습니다. 이 장치 안에는 서비스를 받을 수 있는 부품이 없습니다.

- 여기에서 지정하지 않은 방식의 제어, 조절 또는 실행으로 인해 위험한 레이저 광선에 노출될 수 있습니다.



위험

일부 레이저 제품에는 클래스 3A 또는 클래스 3B 레이저 다이오드가 들어 있습니다. 다음을 주의하십시오.

열면 레이저 광선에 노출됩니다. 광선을 주시하거나 광학 기계를 직접 쳐다보지 않도록 하고 광선에 노출되지 않도록 하십시오.

경고문 4



≥18 kg (37 lbs)



≥ 32 kg (70.5 lbs)



≥ 55 kg (121.2 lbs)

주의:

기계를 들 때는 안전하게 들어 올리십시오.

경고문 5



주의:

장치의 전원 제어 버튼 및 전원 공급기의 전원 스위치는 장치에 공급되는 전류를 차단하지 않습니다. 장치에 둘 이상의 전원 코드가 연결되어 있을 수도 있습니다. 장치에서 모든 전류를 차단하려면 모든 전원 코드가 전원으로부터 차단되어 있는지 확인하십시오.



경고문 10



주의:

서랍형 모델의 장치 상단에 82 kg(180 lbs.)이 넘는 물체를 올려 놓지 마십시오.



>82 kg (180 lbs)

Importante:

Todas las declaraciones de precaución de esta IBM documentation empiezan con un número. Dicho número se emplea para establecer una referencia cruzada de una declaración de precaución o peligro en inglés con las versiones traducidas que de dichas declaraciones pueden encontrarse en esta sección.

Por ejemplo, si una declaración de peligro empieza con el número 1, las traducciones de esta declaración de precaución aparecen en esta sección bajo Declaración 1.

Lea atentamente todas las declaraciones de precaución y peligro antes de llevar a cabo cualquier operación.

Declaración 1



PELIGRO

La corriente eléctrica de los cables telefónicos, de alimentación y de comunicaciones es perjudicial.

Para evitar una descarga eléctrica:

- No conecte ni desconecte ningún cable ni realice las operaciones de instalación, mantenimiento o reconfiguración de este producto durante una tormenta.
- Conecte cada cable de alimentación a una toma de alimentación eléctrica con conexión a tierra y cableado correctos.
- Conecte a tomas de alimentación con un cableado correcto cualquier equipo que vaya a estar conectado a este producto.
- Si es posible, utilice una sola mano cuando conecte o desconecte los cables de señal.
- No encienda nunca un equipo cuando haya riesgos de incendio, de inundación o de daños estructurales.
- Desconecte los cables de alimentación, sistemas de telecomunicaciones, redes y módems conectados antes de abrir las cubiertas del dispositivo a menos que se indique lo contrario en los procedimientos de instalación y configuración.
- Conecte y desconecte los cables tal como se describe en la tabla siguiente cuando desee realizar una operación de instalación, de traslado o de apertura de las cubiertas para este producto o para los dispositivos conectados.

Para la conexión	Para la desconexión
<ol style="list-style-type: none">1. APÁGUELO todo.2. En primer lugar, conecte los cables a los dispositivos.3. Conecte los cables de señal a los conectores.4. Conecte cada cable de alimentación a la toma de alimentación.5. ENCIENDA el dispositivo.	<ol style="list-style-type: none">1. APÁGUELO todo.2. En primer lugar, retire cada cable de alimentación de la toma de alimentación.3. Retire los cables de señal de los conectores.4. Retire los cables de los dispositivos.

Declaración 2



PRECAUCIÓN:

Cuando desee sustituir la batería de litio, utilice únicamente el número de pieza 33F8354 de IBM o cualquier tipo de batería equivalente que recomiende el fabricante. Si el sistema tiene un módulo que contiene una batería de litio, sustitúyalo únicamente por el mismo tipo de módulo, que ha de estar creado por el mismo fabricante. La batería contiene litio y puede explotar si el usuario no la utiliza ni la maneja de forma adecuada o si no se desprende de la misma como corresponde.

No realice las acciones siguientes:

- Arrojarla al agua o sumergirla
- Calentarla a una temperatura que supere los 100°C (212°F)
- Repararla o desmontarla

Despréndase de la batería siguiendo los requisitos que exija el reglamento o la legislación local.

Declaración 3



PRECAUCIÓN:

Cuando instale productos láser (como, por ejemplo, CD-ROM, unidades DVD, dispositivos de fibra óptica o transmisores), tenga en cuenta las advertencias siguientes:

- No retire las cubiertas. Si retira las cubiertas del producto láser, puede quedar expuesto a radiación láser perjudicial. Dentro del dispositivo no existe ninguna pieza que requiera mantenimiento.
- El uso de controles o ajustes o la realización de procedimientos que no sean los que se han especificado aquí pueden dar como resultado una exposición perjudicial a las radiaciones.



PELIGRO

Algunos productos láser contienen un diodo de láser incorporado de Clase 3A o de Clase 3B. Tenga en cuenta la advertencia siguiente.

Cuando se abre, hay radiación láser. No mire fijamente el rayo ni lleve a cabo ningún examen directamente con instrumentos ópticos; evite la exposición directa al rayo.

Declaración 4

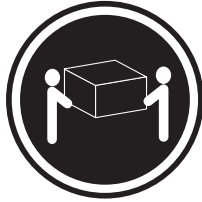

≥18 kg



≥32 kg

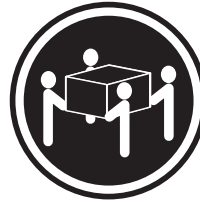

≥55 kg

PRECAUCIÓN:

Tome medidas de seguridad al levantar el producto.

Declaración 5



PRECAUCIÓN:

El botón de control de alimentación del dispositivo y el interruptor de alimentación de la fuente de alimentación no apagan la corriente eléctrica suministrada al dispositivo. Es posible también que el dispositivo tenga más de un cable de alimentación. Para eliminar la corriente eléctrica del dispositivo, asegúrese de desconectar todos los cables de alimentación de la fuente de alimentación.



Declaración 8



PRECAUCIÓN:

No retire nunca la cubierta de una fuente de alimentación ni ninguna pieza que tenga adherida la etiqueta siguiente.



Existen niveles perjudiciales de energía, corriente y voltaje en los componentes que tienen adherida esta etiqueta. Dentro de estos componentes no existe ninguna pieza que requiera mantenimiento. Si sospecha que alguna de estas piezas tiene un problema, póngase en contacto con un técnico de servicio.

Declaración 10
PRECAUCIÓN:

No coloque ningún objeto que pese más de 82 kg (180 libras) encima de los dispositivos montados en bastidor.



Appendix C. Notices

This information was developed for products and services offered in the U.S.A.

IBM may not offer the products, services, or features discussed in this document in other countries. Consult your local IBM representative for information on the products and services currently available in your area. Any reference to an IBM product, program, or service is not intended to state or imply that only that IBM product, program, or service may be used. Any functionally equivalent product, program, or service that does not infringe any IBM intellectual property right may be used instead. However, it is the user's responsibility to evaluate and verify the operation of any non-IBM product, program, or service.

IBM may have patents or pending patent applications covering subject matter described in this document. The furnishing of this document does not give you any license to these patents. You can send license inquiries, in writing, to:

*IBM Director of Licensing
IBM Corporation
North Castle Drive
Armonk, NY 10504-1785
U.S.A.*

INTERNATIONAL BUSINESS MACHINES CORPORATION PROVIDES THIS PUBLICATION "AS IS" WITHOUT WARRANTY OF ANY KIND, EITHER EXPRESS OR IMPLIED, INCLUDING, BUT NOT LIMITED TO, THE IMPLIED WARRANTIES OF NON-INFRINGEMENT, MERCHANTABILITY OR FITNESS FOR A PARTICULAR PURPOSE. Some states do not allow disclaimer of express or implied warranties in certain transactions, therefore, this statement may not apply to you.

This information could include technical inaccuracies or typographical errors. Changes are periodically made to the information herein; these changes will be incorporated in new editions of the publication. IBM may make improvements and/or changes in the product(s) and/or the program(s) described in this publication at any time without notice.

Any references in this information to non-IBM Web sites are provided for convenience only and do not in any manner serve as an endorsement of those Web sites. The materials at those Web sites are not part of the materials for this IBM product, and use of those Web sites is at your own risk.

IBM may use or distribute any of the information you supply in any way it believes appropriate without incurring any obligation to you.

Edition notice

© COPYRIGHT INTERNATIONAL BUSINESS MACHINES CORPORATION, 2002, 2003. All rights reserved.

Note to U.S. Government Users Restricted Rights — Use, duplication or disclosure restricted by GSA ADP Schedule Contract with IBM Corp.

Trademarks

The following terms are trademarks of International Business Machines Corporation in the United States, other countries, or both:

Active Memory	Predictive Failure Analysis
Active PCI	PS/2
Active PCI-X	ServeRAID
Alert on LAN™	ServerGuide
C2T Interconnect	ServerProven
Chipkill	TechConnect®
EtherJet™	Tivoli®
e-business logo	Tivoli Enterprise™
@server	Update Connector™
FlashCopy®	Wake on LAN
IBM	XA-32
IntelliStation	XA-64
Light Path Diagnostics	X-Architecture
NetBAY	XceL4
Netfinity®	XpandOnDemand
NetView®	xSeries
OS/2 WARP®	

Lotus®, Lotus Notes®, SmartSuite®, and Domino™ are trademarks of Lotus Development Corporation and/or IBM Corporation in the United States, other countries, or both.

ActionMedia, LANDesk®, MMX™, Pentium®, ProShare, and Xeon are trademarks of Intel Corporation in the United States, other countries, or both.

Microsoft, Windows, and Windows NT are trademarks of Microsoft Corporation in the United States, other countries, or both.

UNIX® is a registered trademark of The Open Group in the United States and other countries.

Java™ and all Java-based trademarks and logos are trademarks or registered trademarks of Sun Microsystems, Inc. in the United States, other countries, or both.

Linux is a registered trademark of Linus Torvalds.

Other company, product, or service names may be trademarks or service marks of others.

Important notes

Processor speeds indicate the internal clock speed of the microprocessor; other factors also affect application performance.

CD-ROM drive speeds list the variable read rate. Actual speeds vary and are often less than the maximum possible.

When referring to processor storage, real and virtual storage, or channel volume, KB stands for approximately 1000 bytes, MB stands for approximately 1 000 000 bytes, and GB stands for approximately 1 000 000 000 bytes.

When referring to hard disk drive capacity or communications volume, MB stands for 1 000 000 bytes, and GB stands for 1 000 000 000 bytes. Total user-accessible capacity may vary depending on operating environments.

Maximum internal hard disk drive capacities assume the replacement of any standard hard disk drives and population of all hard disk drive bays with the largest currently supported drives available from IBM.

Maximum memory may require replacement of the standard memory with an optional memory module.

IBM makes no representation or warranties regarding non-IBM products and services that are ServerProven, including but not limited to the implied warranties of merchantability and fitness for a particular purpose. These products are offered and warranted solely by third parties.

IBM makes no representations or warranties with respect to non-IBM products. Support (if any) for the non-IBM products is provided by the third party, not IBM.

Some software may differ from its retail version (if available), and may not include user manuals or all program functionality.

Product recycling and disposal

This unit contains materials such as circuit boards, cables, electromagnetic compatibility gaskets, and connectors which may contain lead and copper/beryllium alloys that require special handling and disposal at end of life. Before this unit is disposed of, these materials must be removed and recycled or discarded according to applicable regulations. IBM offers product-return programs in several countries. For country-specific instructions, refer to the following Web site:
<http://www.ibm.com/ibm/environment/products/prp.shtml>.

This product may contain a sealed lead acid, nickel cadmium, nickel metal hydride, lithium, or lithium ion battery. Consult your user manual or service manual for specific battery information. The battery must be recycled or disposed of properly. Recycling facilities may not be available in your area. For information on disposal of batteries, contact your local waste disposal facility.

In the United States, IBM has established a collection process for reuse, recycling, or proper disposal of used IBM sealed lead acid, nickel cadmium, nickel metal hydride, and battery packs from IBM equipment. For information on proper disposal of these batteries, contact IBM at 1-800-426-4333. Have the IBM part number listed on the battery available prior to your call.

Electronic emission notices

Federal Communications Commission (FCC) statement

Note: This equipment has been tested and found to comply with the limits for a Class A digital device, pursuant to Part 15 of the FCC Rules. These limits are designed to provide reasonable protection against harmful interference when the

equipment is operated in a commercial environment. This equipment generates, uses, and can radiate radio frequency energy and, if not installed and used in accordance with the instruction manual, may cause harmful interference to radio communications. Operation of this equipment in a residential area is likely to cause harmful interference, in which case the user will be required to correct the interference at his own expense.

Properly shielded and grounded cables and connectors must be used in order to meet FCC emission limits. Properly shielded and grounded cables and connectors must be used in order to meet FCC emission limits. IBM is not responsible for any radio or television interference caused by using other than recommended cables and connectors or by using other than recommended cables and connectors or by unauthorized changes or modifications to this equipment. Unauthorized changes or modifications could void the user's authority to operate the equipment.

This device complies with Part 15 of the FCC Rules. Operation is subject to the following two conditions: (1) this device may not cause harmful interference, and (2) this device must accept any interference received, including interference that may cause undesired operation.

Industry Canada Class A emission compliance statement

This Class A digital apparatus complies with Canadian ICES-003.

Avis de conformité à la réglementation d'Industrie Canada

Cet appareil numérique de la classe A est conforme à la norme NMB-003 du Canada.

Australia and New Zealand Class A statement

Attention: This is a Class A product. In a domestic environment this product may cause radio interference in which case the user may be required to take adequate measures.

United Kingdom telecommunications safety requirement

Notice to Customers

This apparatus is approved under approval number NS/G/1234/J/100003 for indirect connection to public telecommunication systems in the United Kingdom.

European Union EMC Directive conformance statement

This product is in conformity with the protection requirements of EU Council Directive 89/336/EEC on the approximation of the laws of the Member States relating to electromagnetic compatibility. IBM cannot accept responsibility for any failure to satisfy the protection requirements resulting from a nonrecommended modification of the product, including the fitting of non-IBM option cards.

This product has been tested and found to comply with the limits for Class A Information Technology Equipment according to CISPR 22/European Standard EN 55022. The limits for Class A equipment were derived for commercial and industrial environments to provide reasonable protection against interference with licensed communication equipment.

Attention: This is a Class A product. In a domestic environment this product may cause radio interference in which case the user may be required to take adequate measures.

Taiwanese Class A warning statement

警告使用者：
這是甲類的資訊產品，在居住的環境中使用時，可能會造成射頻干擾，在這種情況下，使用者會被要求採取某些適當的對策。

Chinese Class A warning statement

聲 明
此為 A 級產品。在生活環境中，該產品可能會造成無線電干擾。在這種情況下，可能需要用戶對其干擾採取切实可行的措施。

Japanese Voluntary Control Council for Interference (VCCI) statement

この装置は、情報処理装置等電波障害自主規制協議会（VCCI）の基準に基づくクラスA情報技術装置です。この装置を家庭環境で使用すると電波妨害を引き起こすことがあります。この場合には使用者が適切な対策を講ずるよう要求されることがあります。



Part Number: 48P9718

(1P) P/N: 48P9718

